

VeriQBench: A Benchmark for Multiple Types of Quantum Circuits

Kean Chen^{1,3}, Wang Fang^{1,3}, Ji Guan^{1,*}, Xin Hong⁴, Mingyu Huang^{1,3}, Junyi Liu^{1,3}, Qisheng Wang², and Mingsheng Ying^{1,2,†}

¹State Key Laboratory of Computer Science, Institute of Software, Chinese Academy of Sciences, China

²Department of Computer Science and Technology, Tsinghua University, China

³The University of Chinese Academy of Sciences, China

⁴Centre for Quantum Software and Information, University of Technology Sydney, Australia

June 23, 2022

Abstract

In this paper, we introduce *VeriQBench* — an open source benchmark for quantum circuits. It offers high-level quantum circuit abstractions of various circuit types, including: 1) combinational, 2) dynamic, 3) sequential, and 4) variational quantum circuits, which cover almost all existing types of quantum circuits in the literature. Meanwhile, *VeriQBench* is a versatile benchmark which can be used in verifying quantum software for different applications, as is evidenced by the existing works including quantum circuit verification (e.g., equivalence checking [Hon+21a; WLY21] and model checking [Yin21]), simulation (e.g., fault simulation), testing (e.g., test pattern generation [CY22]) and debugging (e.g., runtime assertions [Li+20b]). All the circuits are described in OpenQASM and are validated on Qiskit and QCOR simulators. With the hope that it can be used by other researchers, *VeriQBench* is released at: <https://github.com/Veri-Q/Benchmark>.

*guanj@ios.ac.cn

†yingms@ios.ac.cn

Contents

1	Introduction	2
2	Combinational Quantum Circuits	4
2.1	Quantum Algorithms	4
2.1.1	Bernstein-Vazirani Algorithm	4
2.1.2	Quantum Fourier Transform	6
2.1.3	Quantum Phase Estimation	7
2.1.4	Grover’s Algorithm	8
2.1.5	Quantum Adder	10
2.2	Reversible Circuits	11
2.3	Qubit Mapping	13
2.4	Random Circuits	14
2.4.1	Random Clifford Circuits	14
2.4.2	Quantum Volume	15
2.4.3	Supremacy Circuits	17
3	Dynamic Quantum Circuits	17
3.1	Quantum Teleportation	18
3.2	Semiclassical Fourier Transform	18
3.3	Iterative Phase Estimation	19
3.4	Quantum Error correction	21
3.5	State Injection	22
4	Sequential Quantum Circuits	23
4.1	Repeat-Until-Success	23
4.2	Quantum Walk	25
4.3	Classical Control	26
5	Variational Quantum Circuits	27
5.1	Variational Quantum Eigensolver	27
6	Validation	28
7	Example Applications	29

1 Introduction

Quantum circuits are the basic components in quantum computing. With the rapid development in hardware implementation of quantum circuits in experiments, there also emerge many approaches to characterise and evaluate quantum computing models by simulating and comparing quantum circuits, such as quantum noise effects [Liu+21], variational circuit training [Bro+20] and (approximate) equivalence checking [VMH07; YM10; BW20b; BW20a; Hon+21a]. In particular, quantifying the practical performance of some carefully chosen

quantum circuits is a common way to evaluate the performance of quantum devices, especially in the current NISQ (Noisy Intermediate-Scale Quantum) era, where quantum noise from the surrounding environment is unavoidable. These quantum circuits are generated from different fields, such as random protocols [Aru+19], quantum algorithms [NC02; Chi17], including variational quantum algorithms [Per+14; FGG14; Had+19; Til+21; Cer+21] and classical reversible circuits [AD16]. Subsequently, in the recent years, diverse quantum circuit benchmarks have been proposed with different evaluation metrics, such as QASMBench [Li+20a], quantum LINPACK benchmark [DL21], SupermarQ [Tom+22] and the quantum volume protocol [Cro+19].

In this paper, we present a new quantum circuit benchmark, called *VeriQBench*, for a different purpose. It was initially designed for testing our own QDA (Design Automation for Quantum Computing) tool series *VeriQ*. But we hope it can be applicable in various fields, given the following features:

- **Diversity:** It includes the most commonly-used quantum circuits, namely combinational quantum circuits, dynamic quantum circuits, sequential quantum circuits, and variational quantum circuits. These circuits cover all types of quantum circuits existing in the literature. Furthermore, the quantum circuits in our benchmark are diverse in structure (e.g. the layout of 2-qubit circuits) and complexity (e.g. circuit size and depth).
- **Scalability:** The circuit scales in our benchmark vary widely, ranging from 2 qubits up to > 50 qubits, which are divided into three classes, *i.e.* small-scale (< 20 qubits), medium-scale (20 – 50 qubits) and large-scale (> 50 qubits).
- **Easy-to-use:** All the circuits in our benchmark are described using the OpenQASM quantum assembly language and provided as “.qasm” files. Furthermore, most of them can be converted to other representations such as Q#, PyQuil, Cirq, etc. through *q-convert* tool, which is available online: <http://quantum-circuit.com/qconvert>.
- **Evolution:** For most of the quantum circuits in our benchmark, we provide a series of scripts for users to generate quantum circuits of an arbitrary number of qubits. This ensures that our benchmark can evolve as the available circuit scales of quantum technologies increase.

Our benchmark can work with different evaluation metrics to verify quantum software — comparing and assessing the effectiveness and efficiency of quantum and classical (simulation) algorithms designed for quantum circuits. The circuits in our benchmark are collected from researches in a variety of fields, including equivalence checking [Hon+21a; WLY21], circuit testing [CY22] and circuit optimizing [AMM14; Nam+18]. This improves the diversity and practical feasibility of the benchmark. On this basis, the circuit types and scales are further extended and standardized to form a scalable and evolvable benchmark. To demonstrate the validity, all quantum circuits in our benchmark are implemented and validated by Qiskit [Qis] — an open source SDK for quantum

computation, and QCOR [Ngu+20] — a programming language and a compiler for the heterogeneous quantum-classical model of computation.

This paper is organised as follows: we start from the basic type of quantum circuits, namely combinational quantum circuits in Section 2, which includes some fundamental quantum algorithms, reversible circuits, qubit mapping and random quantum circuits. Then dynamic, sequential and variational quantum circuits are presented in Sections 3, 4 and 5, respectively. In Section 6, we validate all quantum circuits on Qiskit and QCOR. In the last section, we discuss some example applications of the benchmarks. Of course, we hope that this benchmark can be used by other researchers. The benchmark *VeriQBench* is released at: <https://github.com/Veri-Q/Benchmark>.

2 Combinational Quantum Circuits

The most basic and commonly used type of quantum circuit is the combinational quantum circuit, with examples including some of the popular quantum algorithms such as the Bernstein-Vazirani algorithm, quantum Fourier transform and quantum phase estimation. In our benchmark, we include the most commonly used combinational circuits and divide them into four categories: quantum algorithms, reversible circuits, circuits for qubit mapping, and random quantum circuits.

2.1 Quantum Algorithms

2.1.1 Bernstein-Vazirani Algorithm

Description. Bernstein-Vazirani algorithm [BV97] is an algorithm that can be used to find the hidden string s given a boolean function $f(x)$, where $f(x) = \langle s, x \rangle = s_0x_0 \oplus s_1x_1 \oplus \dots \oplus s_nx_n$. For the classical algorithm, it normally needs $\mathcal{O}(n)$ times to complete this task using a bit-by-bit inquiring method. But, it only needs $\mathcal{O}(1)$ times using the Bernstein-Vazirani algorithm suppose that you are given an oracle O_s , where $O_s |x\rangle |y\rangle = |x\rangle |f(x) \oplus y\rangle$.

First, apply a series of Hadamard gates to state $|0\rangle \dots |0\rangle |1\rangle$ to change the state to $\frac{1}{\sqrt{2^n}} \sum_{x=0}^{2^n-1} |x\rangle \otimes \frac{|0\rangle - |1\rangle}{\sqrt{2}}$. Then, applying the oracle, the state will become $\frac{1}{\sqrt{2^n}} \sum_{x=0}^{2^n-1} (-1)^{\langle s, x \rangle} |x\rangle \otimes \frac{|0\rangle - |1\rangle}{\sqrt{2}}$. Finally, apply a series of Hadamard gates, and the final state will change to $|s\rangle |1\rangle$. At the end, measuring the first n qubits gives the value of s .

For $s = 101$ and $s = 111$, the corresponding circuits are shown in Figure 1. In these two circuits, an X gate is added at the last qubit to change the initial state from $|0\rangle$ to $|1\rangle$, and the $CNOT$ gates are used for implementing the oracle. For these circuits, setting input state $|0\rangle \dots |0\rangle$ and measuring at the end will give the hidden string s .

OpenQASM Code. The following gives the description of the circuit for $s = 101$ using OpenQASM 2.0.

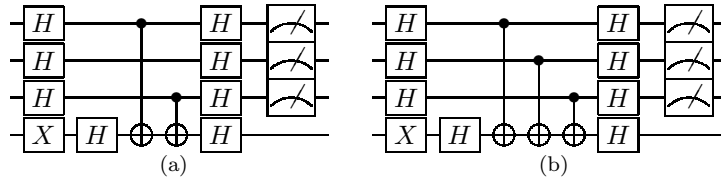

Figure 1: Two examples of the Bernstein-Vazirani algorithm, where (a) $s = 101$ and (b) $s = 111$.

```

1 OPENQASM 2.0;
2 include "qelib1.inc";
3 qreg q[4];
4 creg c[4];
5 h q[0];
6 h q[1];
7 h q[2];
8 x q[3];
9 h q[3];
10 cx q[0],q[3];
11 cx q[2],q[3];
12 h q[0];
13 h q[1];
14 h q[2];
15 h q[3];

```

Generation Script. The circuit for arbitrary hidden string s can be generated using the following code. For this circuit, the number of qubits is expected to be one more than the length of the hidden string.

```

1 def gen_bv(qubits, hiddenString):
2
3     cir = QuantumCircuit(qubits, qubits)
4
5     for i in range(qubits - 1):
6         cir.h(i)
7
8     cir.x(qubits - 1)
9     cir.h(qubits - 1)
10    hiddenString = list(hiddenString)
11    for i in range(len(hiddenString)):
12        if hiddenString[i] == "1":
13            cir.cx(i, qubits - 1)
14
15    for i in range(qubits):
16        cir.h(i)
17
18    return cir.qasm()

```

2.1.2 Quantum Fourier Transform

Description. Quantum Fourier transform [NC02] is a commonly used algorithm in quantum computing. It turns an input state $|j\rangle$ to its Fourier transform.

$$QFT |j\rangle = \frac{1}{\sqrt{N}} \sum_{k=0}^{N-1} e^{2\pi i j k / N} |k\rangle.$$

The circuit for 3-qubit quantum Fourier transform is shown in Figure 2. It is easy to observe from this circuit that the quantum Fourier transform can be implemented using a series of Hadamard gates and a set of Control- R_k gates, where

$$R_k = \begin{bmatrix} 1 & 0 \\ 0 & e^{2\pi i / 2^k} \end{bmatrix}.$$

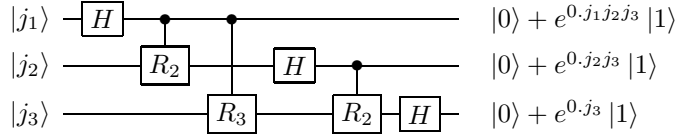

Figure 2: Quantum circuit for Fourier Transform.

OpenQASM Code. The OpenQASM 2.0 description of this circuit is shown below.

```

1 OPENQASM 2.0;
2 include "qelib1.inc";
3 qreg q[3];
4 creg c[3];
5 h q[0];
6 cu1(pi/2) q[0],q[1];
7 cu1(pi/4) q[0],q[2];
8 h q[1];
9 cu1(pi/2) q[1],q[2];
10 h q[2];

```

Generation Script. The circuit for arbitrary number of qubits quantum Fourier transform can be generated using the following code. This code extended the circuit shown in Figure 2 to arbitrary qubits.

```

1 def gen_qft(qubits):
2
3     cir = QuantumCircuit(qubits, qubits)
4     for q in range(qubits):
5         cir.h(q)
6         for tar in range(q + 1, qubits):
7             theta = np.pi / 2 ** (tar - q)
8             cir.cu1(theta, q, tar)
9
10    return cir.qasm()

```

2.1.3 Quantum Phase Estimation

Description. Phase estimation [NC02] is an algorithm that can be used to estimate the phase φ in an eigenvalue of a unitary U , where $U|\psi\rangle = e^{2\pi i\varphi}|\psi\rangle$ for some $|\psi\rangle$. The corresponding circuit is shown in Figure 3.

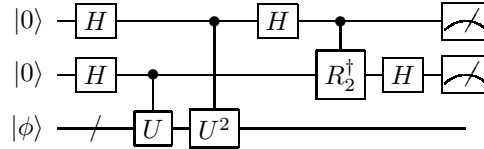

Figure 3: Quantum circuit for phase estimation.

The process can be conducted by first constructing an superposition state and then applying a series of controlled- U^{2^k} gates. Then, an inverse quantum Fourier transform can be used to extract the corresponding value of the phase.

OpenQASM Code. The following gives the OpenQASM 2.0 description of this circuit. In this circuit, we suppose that U is a single qubit diagonal matrix

$$U = \begin{bmatrix} 1 & 0 \\ 0 & e^{2\pi i\varphi} \end{bmatrix},$$

and here we take $\varphi = 1/1024$ as an example.

```

1 OPENQASM 2.0;
2 include "qelib1.inc";
3 qreg q[4];
4 creg c[4];
5 h q[0];
6 h q[1];
7 h q[2];
8 cu1(pi/512) q[2],q[3];
9 cu1(pi/256) q[1],q[3];
10 cu1(pi/128) q[0],q[3];
11 h q[0];
12 cu1(-pi/2) q[0],q[1];
13 cu1(-pi/4) q[0],q[2];
14 h q[1];
15 cu1(-pi/2) q[1],q[2];
16 h q[2];

```

Generation Script. The python code for generating the circuits is as follows. You can assign the number of qubits of the circuit and also the phase φ . Then, running this circuit will give the estimation of the phase to a precision restricted by the number of qubits.

```

1 def gen_pe(qubits, the_phase):
2
3     cir=QuantumCircuit(qubits+1,qubits+1)

```

```

4
5     for q in range(qubits):
6         cir.h(q)
7
8     for q in range(qubits-1,-1,-1):
9         cir.cu1(np.pi*the_phase*2**(qubits-q),q,qubits)
10
11    for q in range(qubits):
12        cir.h(q)
13        for tar in range(q+1,qubits):
14            cir.cu1(-np.pi/(2**(tar-q)),q,tar)
15
16    return cir.qasm()

```

2.1.4 Grover's Algorithm

Description. Grover's algorithm [Gro96] is one of the most commonly used algorithms in quantum computing to search the solution of an integer function.

Suppose you are given an oracle O such that $O|x\rangle = (-1)^{f(x)}|x\rangle$, then initialise the state to be the equal superposition state $|\psi\rangle = \frac{1}{\sqrt{N}} \sum_{x=0}^{N-1} |x\rangle$, and iteratively apply the Grover operator

$$G = (2|\psi\rangle\langle\psi| - I)O,$$

and finally measure all the qubits, you will get a solution of the function $f(x)$ with a probability close to 1.

Figure 4 gives an example of the Grover's algorithm. Here, $f(x) = x_1 \cdot x_2$, running this circuit and measuring at the end will obtain 11, which is the solution of this function.

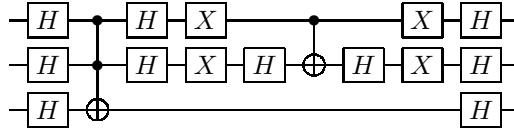

Figure 4: An example of Grover's algorithm. Here, $f(x)$ is a 2-bit function and $f(x) = x_1 \cdot x_2$.

OpenQASM Code. The OpenQASM 2.0 description of this circuit is as follows.

```

1 OPENQASM 2.0;
2 include "qelib1.inc";
3 qreg q[3];
4 creg c[3];
5 h q[0];
6 h q[1];
7 h q[2];

```



```

8 ccx q[0],q[1],q[2];
9 h q[0];
10 h q[1];
11 x q[0];
12 x q[1];
13 h q[1];
14 cx q[0],q[1];
15 h q[1];
16 x q[0];
17 x q[1];
18 h q[0];
19 h q[1];
20 h q[2];

```

Generation Script. The python code for generating circuits for arbitrary qubits Grover's search is as follows. In this code, you can assign the number of qubits n of the search space, where the solution is $|1\rangle^{\otimes n}$. Then there will be one qubit serving as oracle workspace and $n - 2$ qubits as ancilla qubits. Thus, the circuit will totally have $2n - 1$ qubits and the $C^n(X)$ will be decomposed to a series of CCX (*i.e.* Toffoli) gates using the ancilla qubits.

```

1 def gen_grover(qubits, r):
2     cir = QuantumCircuit(2 * qubits - 1)
3     # add H
4     for q in range(qubits):
5         cir.h(q)
6     cir.h(2 * qubits - 2)
7     for k in range(r):
8         # add tofolli
9         cir.ccx(0, 1, qubits)
10        for q in range(2, qubits):
11            cir.ccx(q, q + qubits - 2, q + qubits - 1)
12        for q in range(qubits - 2, 1, -1):
13            cir.ccx(q, q + qubits - 2, q + qubits - 1)
14        if qubits > 2:
15            cir.ccx(0, 1, qubits)
16            # add H
17            for q in range(qubits):
18                cir.h(q)
19            # add X
20            for q in range(qubits):
21                cir.x(q)
22            cir.h(qubits - 1)
23            if qubits == 2:
24                cir.cx(0, 1)
25            elif qubits == 3:
26                cir.ccx(0, 1, 2)
27            else:
28                cir.ccx(0, 1, qubits)
29                for q in range(2, qubits - 2):

```

```

30         cir.ccx(q, q + qubits - 2, q + qubits - 1)
31         cir.ccx(qubits - 2, 2 * qubits - 4, qubits - 1)
32
33         for q in range(qubits - 3, 1, -1):
34             cir.ccx(q, q + qubits - 2, q + qubits - 1)
35         if qubits > 2:
36             cir.ccx(0, 1, qubits)
37         cir.h(qubits - 1)
38         # add X
39         for q in range(qubits):
40             cir.x(q)
41         # add H
42         for q in range(qubits):
43             cir.h(q)
44
45         cir.h(2 * qubits - 2)
46         return cir.qasm()

```

2.1.5 Quantum Adder

Description. Quantum adder is a quantum circuit to implement add operation on two bit strings. For example, if we compute '2+3=5', then we represent the input string as '010' and '011', and the expected output bit string is '101'. The implementation of the quantum adder circuit is illustrated as follows, and the additional qubits are used to store the carry bit [CS08].

OpenQASM Code. The OpenQASM description of 3-bit adder circuit is shown as follows.

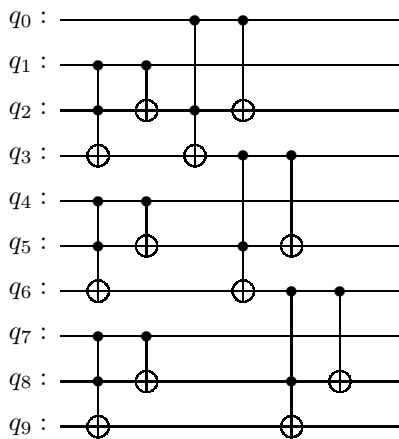

Figure 5: Circuit of 3-bit adder

```

1 OPENQASM 2.0;
2 include "qelib1.inc";
3 qreg q[10];
4 ccx q[1],q[2],q[3];
5 cx q[1],q[2];
6 ccx q[4],q[5],q[6];
7 cx q[4],q[5];
8 ccx q[7],q[8],q[9];
9 cx q[7],q[8];
10 ccx q[0],q[2],q[3];
11 ccx q[3],q[5],q[6];
12 ccx q[6],q[8],q[9];
13 cx q[0],q[2];
14 cx q[3],q[5];
15 cx q[6],q[8];

```

Generation Script. The python code for generating an adder circuit is as follows, the function takes the number of qubits as the input and outputs the OpenQASM text of the circuit.

```

1 def header(nq):
2     str = ""
3     str += "OPENQASM 2.0;\n"
4     str += "include \"qelib1.inc\";\n"
5     str += "qreg q[%d];\n"%(nq)
6     return str
7
8 def carry_gate(s):
9     str = ''
10    str += "ccx q[%d],q[%d],q[%d];\n"%(s+1, s+2, s+3)
11    str += "cx q[%d],q[%d];\n"%(s+1, s+2)
12    return str
13
14 def adder(numq):
15    str = "//Adder with %d qubits input.\n"%numq
16    str += header(3*numq+1)
17    for i in range(numq):
18        str += carry_gate(3*i)
19    for i in range(numq):
20        str += "ccx q[%d],q[%d],q[%d];\n"%(3*i, 3*i+2, 3*i+3)
21    for i in range(numq):
22        str += "cx q[%d],q[%d];\n"%(3*i, 3*i+2)
23    return str

```

2.2 Reversible Circuits

Description. A classical n -bit reversible gate is a bijective mapping f from the set $\{0,1\}^n$ of n -bit data onto itself. Thus the vector of input states can always be reconstructed from the vector of output states. A combinational logic circuit is reversible if it only contains reversible gates and has no fan-out.

Classical reversible circuits may be implemented in quantum technology and have important applications in many quantum algorithms such as the arithmetic module of Shor’s Algorithm and the oracle of Grover’s Algorithm.

We collect the classical reversible circuits in the Reversible Logic Synthesis Benchmarks Page [Mas]. The following are the elementary gates they used:

Definition 1 *A generalized Toffoli gate $TOF(x_1, x_2, \dots, x_n; x_{n+1})$ is a gate which maps a Boolean pattern $(x_1, x_2, \dots, x_n, x_{n+1})$ to $(x_1, x_2, \dots, x_n, x_{n+1} + x_1x_2 \dots x_n)$, where “+” is a modula-2 addition.*

Examples:

1. NOT gate is a $TOF(\emptyset; a)$ gate.
2. CNOT gate is a $TOF(a; b)$ gate.
3. Original Toffoli gate is a $TOF(a, b; c)$.

Definition 2 *A generalized Fredkin gate $FRE(x_1, x_2, \dots, x_n; x_{n+1}, x_{n+2})$ is a gate which maps Boolean pattern $(x_1, x_2, \dots, x_n, x_{n+1}, x_{n+2})$ to $(x_1, x_2, \dots, x_n, x_{n+2}, x_{n+1})$ if and only if Boolean product $x_1x_2 \dots x_n = 1$, otherwise the pattern is unchanged.*

Examples:

1. SWAP gate is a $FRE(\emptyset; a, b)$ gate.
2. Original Fredkin gate is a $FRE(a; b, c)$ gate.

OpenQASM Code. We translate their circuit description into the OpenQASM 2.0 format. The following gives an example of the reversible 5-bit adder circuit.

```

1 OPENQASM 2.0;
2 include "qelib1.inc";
3 qreg q[11];
4 cx q[3], q[2];
5 cx q[5], q[4];
6 cx q[7], q[6];
7 cx q[9], q[8];
8 cx q[9], q[10];
9 cx q[7], q[9];
10 cx q[5], q[7];
11 cx q[3], q[5];
12 ccx q[0], q[1], q[3];
13 ccx q[2], q[3], q[5];
14 ccx q[4], q[5], q[7];
15 ccx q[6], q[7], q[9];
16 ccx q[8], q[9], q[10];
17 cx q[9], q[8];
18 ccx q[6], q[7], q[9];

```

```

19 cx q[7], q[6];
20 ccx q[4], q[5], q[7];
21 cx q[5], q[4];
22 ccx q[2], q[3], q[5];
23 cx q[3], q[2];
24 ccx q[0], q[1], q[3];
25 cx q[3], q[5];
26 cx q[5], q[7];
27 cx q[7], q[9];
28 cx q[1], q[0];
29 cx q[3], q[2];
30 cx q[5], q[4];
31 cx q[7], q[6];
32 cx q[9], q[8];

```

2.3 Qubit Mapping

Description. On the current superconducting quantum processors, 2-qubit gates are usually unavailable for arbitrary pairs of qubits but only for a small part of them. In order to make all the 2-qubit gates in a circuit available on a specific quantum chip, we have to map the qubits in the circuit to those on the quantum chip and insert some SWAP gates. Meanwhile, we want to make sure that the modified circuit is optimal on depth or the number of inserted SWAP gates. However, since the above problem, known as the qubit mapping problem, is NP-complete, it is difficult to theoretically evaluate the performance of different algorithms. Instead, the performance can be evaluated through benchmarks. [TC20b] presents an algorithm to generate benchmarks of the qubit mapping problems on specific quantum processors along with optimal solutions. We have implemented the generating algorithm in Python. The input and output of the implementation are described below:

The set of qubit pairs which are available for 2-qubit gates is given by the edge set E of a graph G . Given depth d , gate count N and the proportion of 2-qubit gates p_2 , a random quantum circuit which can be executed on the graph G is generated along with an optimal qubit mapping of depth d .

Generation Script. An example of our implementation of QUEKO is shown below:

```

1 from QUEKO import QUEKO
2
3 edges = [(0, 1), (1, 2), (1, 3), (3, 4)]
4 prob = QUEKO(edges=edges, depth=5, gateCount=10, p2=0.3)
5
6 # print the generated OpenQASM program
7 print(prob.qasm2)
8
9 # print the optimal solution, where the  $i$ -th qubit
10 # should be mapped to the  $i$ -th element of the list.
11 print("//" + prob.optimalMapping)

```

OpenQASM Code. A sample output of the above program is:

```
1 OPENQASM 2.0;
2 include "qelib1.inc";
3 qreg q[5];
4 cx q[1], q[2];
5 t q[4];
6 x q[1];
7 h q[0];
8 z q[3];
9 cx q[1], q[3];
10 y q[3];
11 cx q[4], q[2];
12 h q[3];
13 y q[2];
14
15 //[2, 3, 1, 4, 0]
```

Note that the gate `cx q[4], q[2]` is not available on the graph given by `edges`. However, if we apply the map

$$0 \mapsto 2, 1 \mapsto 3, 2 \mapsto 1, 3 \mapsto 4, 4 \mapsto 0$$

to the qubits in the above program, all the `cx` are then available on the graph.

2.4 Random Circuits

2.4.1 Random Clifford Circuits

Description. Clifford operation plays an important role in quantum error correction, randomized benchmarking protocols and quantum circuit simulation. By definition, Clifford operation is a unitary operation taking elements of G_n to elements of G_n , where G_n is the Pauli group on n qubits. Any n -qubit Clifford operation can be simulated using $O(n^2)$ Hadamard, phase and controlled-NOT gates. Clifford group elements are important and frequently encountered subsets of physical-level and fault-tolerant quantum circuits [Bra+21], and sometimes an entire quantum algorithm can be a Clifford circuit (e.g., Bernstein–Vazirani [NC02]).

The Clifford group is a unitary 2-design. That is, a random uniformly distributed element of the Clifford group has exactly the same second order moments as the Haar random unitary operation. This means the random Clifford operations can serve as a substitute for Haar random unitaries in any application that depends only on the second order moments. In Qiskit, the random Clifford is sampled using the method of [BM21]. Then the Clifford circuit is synthesized by the method in [AG04] and optimized by the method in [Bra+21].

Generation Script. The script for generating random Clifford circuit is as follows.

```

1 from qiskit import quantum_info
2
3 def gen_rand_cliff(n):
4
5     cliff=quantum_info.random_clifford(n)
6     AG=quantum_info.decompose_clifford(cliff,method='AG')
7     GD=quantum_info.decompose_clifford(cliff,method='greedy')
8
9     return AG.qasm(),GD.qasm()

```

OpenQASM Code. The following gives a 3-qubit random Clifford circuit in OpenQASM 2.0 format.

```

1 OPENQASM 2.0;
2 include "qelib1.inc";
3 qreg q[3];
4 s q[0];
5 h q[0];
6 s q[1];
7 h q[1];
8 s q[1];
9 h q[2];
10 cx q[2],q[1];
11 cx q[1],q[0];
12 cx q[0],q[2];
13 h q[1];
14 s q[2];
15 h q[2];
16 cx q[2],q[1];
17 s q[2];
18 x q[0];
19 z q[1];

```

2.4.2 Quantum Volume

Description. Quantum volume [Cro+19] is a metric that can be used to measure the capabilities and error rates of a quantum computer. It quantifies the largest random circuit of equal width and depth that the computer can successfully implement. The circuit model used for measuring quantum volume is as follows.

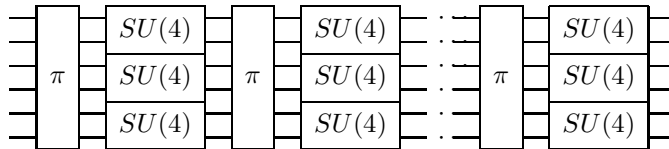

Figure 6: The circuit model for quantum volume.

Here, π is a permutation of qubits, and every $SU(4)$ represents a 2-qubit

unitary gate sampled from the Haar measure on $SU(4)$. There will be d layers of this module if the depth of the circuit is d , and if the number of qubits in the circuit is odd, then every layer will have an idle qubit.

In our benchmark, we give a series of circuits for quantum volume constructed on basic quantum gates. And the $SU(4)$ gates are decomposed using qiskit.

OpenQASM Code. The following is an example of the quantum volume circuit with qubits 2 depth 2, and these circuits are decomposed to cx and $u3$ gate using the standard QASM representation.

```

1 OPENQASM 2.0;
2 include "qelib1.inc";
3 qreg q[2];
4 creg c[2];
5 u3(0.10690831,-1.8026866,0.78825838) q[0];
6 u3(2.4950187,-3.5814199,2.5427764) q[1];
7 cx q[0],q[1];
8 u3(0.82807016,-3*pi/2,pi/2) q[0];
9 u3(pi/2,-pi,-2.8687452) q[1];
10 cx q[0],q[1];
11 u3(0.20800243,0,-3*pi/2) q[0];
12 u3(pi/2,0,-3*pi/2) q[1];
13 cx q[0],q[1];
14 u3(2.0104954,1.3664259,-1.5218768) q[0];
15 u3(0.94734104,-0.84662394,3.2456914) q[1];
16 u3(1.143506,-3.1351223,-0.55632777) q[0];
17 u3(1.3587079,-3.1777958,0.27175853) q[1];
18 cx q[0],q[1];
19 u3(1.0096868,-3*pi/2,pi/2) q[0];
20 u3(pi/2,-pi,-3.0848291) q[1];
21 cx q[0],q[1];
22 u3(0.61517883,0,-3*pi/2) q[0];
23 u3(pi/2,0,-3*pi/2) q[1];
24 cx q[0],q[1];
25 u3(0.09341401,-1.4199754,4.7299314) q[0];
26 u3(0.45442386,-2.4437295,1.2711765) q[1];

```

Generation Script. The script for generating circuit for arbitrary qubits and arbitrary depth is as follows.

```

1 from qiskit.quantum_info.synthesis \
2 import two_qubit_cnot_decompose
3 def random_SU(n):
4     X = (np.random.randn(n, n) + 1j * np.random.randn(n, n))
5     Q, R = linalg.qr(X)
6     Q /= pow(linalg.det(Q), 1/n)
7     return Q
8
9 def gen_qv(qubits, depth):
10    cir = QuantumCircuit(qubits, qubits)

```



```

11     for j in range(depth):
12         perm = np.random.permutation(qubits)
13         for k in range(qubits // 2):
14             q = [int(perm[2 * k]), int(perm[2 * k + 1])]
15             SU = random_SU(4)
16             decomposed_SU = two_qubit_cnot_decompose(SU)
17             for gate in decomposed_SU:
18                 i0 = q[gate[1][0].index]
19                 if gate[0].name == "cx":
20                     i1 = q[gate[1][1].index]
21                     qv.cx(i0, i1)
22                 elif gate[0].name == "u1":
23                     qv.u1(gate[0].params[2], i0)
24                 elif gate[0].name == "u2":
25                     qv.u2(gate[0].params[1], \
26                          gate[0].params[2], i0)
27                 elif gate[0].name == "u3":
28                     qv.u3(gate[0].params[0], \
29                          gate[0].params[1], gate[0].params[2], i0)
30                 elif gate[0].name == "id":
31                     pass
32     return cir.qasm()

```

2.4.3 Supremacy Circuits

Random circuits have been widely used in works related to the quantum supremacy [Boi+18]. Since there are already some benchmarks with such circuits, we just include the existing and commonly used circuits directly in our benchmark. One of such benchmark is GRCS¹. GRCS provides a lot of random circuits, but all in a '.txt' format and not given in the standard OpenQASM language. In our benchmark, we give the OpenQASM version of the random circuits shown in GRCS.

3 Dynamic Quantum Circuits

Dynamic quantum circuit is a model of quantum computation, in which quantum algorithms can be executed in a more flexible classical-quantum hybrid way, which can sometimes reduce the costs of quantum resources. The dynamic quantum circuit is adopted as an alternative and beneficial way for executing quantum algorithms on NISQ devices. Our benchmark includes a series of dynamic quantum circuits.

The biggest difference between dynamic quantum circuits and conventional quantum circuits is that measurements will usually appear in the middle of the circuit, and a series of classically controlled gates will be applied according to the results of the measurements.

¹<https://github.com/sboixo/GRCS>

3.1 Quantum Teleportation

Description. One of the simplest examples of dynamic quantum circuits is teleportation. Teleportation is a protocol for transmitting a qubit between two users by sending two classical bits of information [Ben+93].

OpenQASM Code. The corresponding circuit and the OpenQASM 2.0 description are as follows. The first qubit belongs to Alice and the last qubit belongs to Bob. By first applying a series of quantum gates and sending the measurement result to Bob, Bob can obtain the state of the first qubit of Alice by applying a series of gates according to the measurement information.

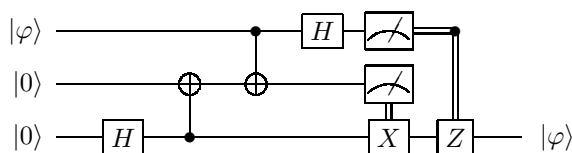

Figure 7: Dynamic quantum circuit for Teleportation.

```

1 OPENQASM 2.0;
2 include "qelib1.inc";
3 qreg q[3];
4 creg c0[1];
5 creg c1[1];
6 creg c2[1];
7 h q[2];
8 cx q[2],q[1];
9 cx q[0],q[1];
10 h q[0];
11 measure q[1] -> c1[0];
12 if(c1==1) x q[2];
13 measure q[0] -> c0[0];
14 if(c0==1) z q[2];

```

3.2 Semiclassical Fourier Transform

Description. The quantum Fourier transform can also be represented as a dynamic quantum circuit form [GN96]. The following gives the detailed information of the dynamic version of the quantum Fourier transform. From Figure 2 and Figure 8 you can see that all the controlled- R_k gates are replaced by a measurement and classically controlled R_k gates.

The advantage of using this dynamic quantum circuit is that there is no need to apply 2-qubit gates during the process, all the 2-qubit gates can be replaced by single-qubit gates chosen according to the measurement results.

OpenQASM Code. Following gives the OpenQASM description of the dynamic version of quantum Fourier transform.

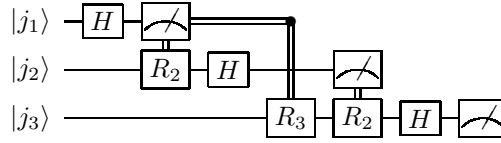

Figure 8: Dynamic quantum circuit for Fourier transform.

```

1 OPENQASM 2.0;
2 include "qelib1.inc";
3 qreg q[3];
4 creg c0[1];
5 creg c1[1];
6 creg c2[1];
7 h q[0];
8 measure q[0] -> c0[0];
9 if(c0==1) u1(pi/2) q[1];
10 if(c0==1) u1(pi/4) q[2];
11 h q[1];
12 measure q[1] -> c1[0];
13 if(c1==1) u1(pi/2) q[2];
14 h q[2];
15 measure q[2] -> c2[0];

```

Generation Script. Similar to the conventional quantum circuit, the corresponding circuit can be generated as follows.

```

1 def gen_dqc_qft(qubits):
2
3     cir= QuantumCircuit(qubits)
4
5     for q in range(qubits):
6         cir.h(q)
7         c= ClassicalRegister(1, 'c'+str(q))
8         cir.add_register(c)
9         cir.measure(q,c)
10        for tar in range(q + 1, qubits):
11            theta = np.pi / 2 ** (tar - q)
12            cir.u1(theta,tar).c_if(c, 1)
13
14        return cir.qasm()

```

3.3 Iterative Phase Estimation

Description. Since the quantum phase estimation uses the inverse quantum Fourier transform as a subroutine, it can also be executed as a dynamic quantum circuit. The dynamic version of quantum phase estimation is as follows.

The advantage of the phase estimation implemented by the dynamic quantum circuit is that the circuit can be executed with only 2-qubit gates, and more

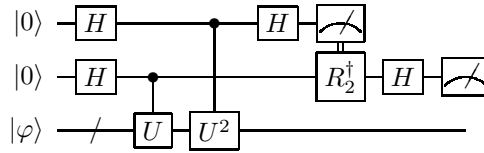

Figure 9: Quantum circuit for phase estimation.

details are shown in [Cór+21].

OpenQASM Code. The following gives the dynamic version of 3-qubit phase estimation.

```

1 OPENQASM 2.0;
2 include "qelib1.inc";
3 qreg q[3];
4 creg c0[1];
5 creg c1[1];
6 h q[0];
7 h q[1];
8 cu1(pi/512) q[1],q[2];
9 cu1(pi/256) q[0],q[2];
10 h q[0];
11 measure q[0] -> c0[0];
12 if(c0==1) u1(-pi/2) q[1];
13 h q[1];
14 measure q[1] -> c1[0];

```

Generation Script. The code for generating dynamic quantum phase estimation circuit of any qubit number is as follows.

```

1 def gen_dqc_pe(qubits, the_phase):
2     cir = QuantumCircuit(qubits + 1)
3
4     for q in range(qubits):
5         cir.h(q)
6
7     for q in range(qubits - 1, -1, -1):
8         cir.cu1(np.pi*the_phase*2**(qubits-q),q,qubits)
9
10    for q in range(qubits):
11        cir.h(q)
12        c = ClassicalRegister(1, 'c' + str(q))
13        cir.add_register(c)
14        cir.measure(q, c)
15    for tar in range(q + 1, qubits):
16        theta = np.pi / 2 ** (tar - q)
17        cir.u1(-theta, tar).c_if(c, 1)
18
19    return cir.qasm()

```

3.4 Quantum Error correction

Description. Another example of dynamic quantum circuits is the circuit for quantum error correction, where a quantum state must first experience a period of syndrome measurement, and then be recovered according to the measurement result.

OpenQASM Code. The following gives the circuit model of error correction as well as the OpenQASM 2.0 description of the bit-flip and phase-flip code [NC02].

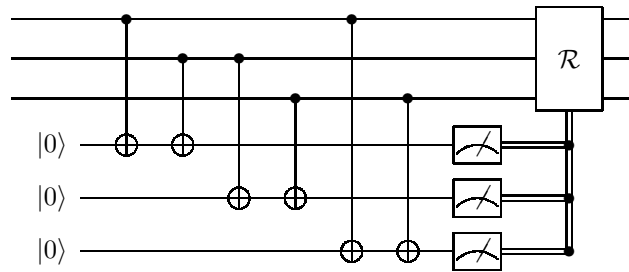

Figure 10: A circuit model for Quantum Error correction.

```

1 OPENQASM 2.0;
2 include "qelib1.inc";
3 qreg q[6];
4 creg c[6];
5 cx q[0],q[3];
6 cx q[1],q[3];
7 cx q[1],q[4];
8 cx q[2],q[4];
9 cx q[0],q[5];
10 cx q[2],q[5];
11 measure q[3] -> c[3];
12 measure q[4] -> c[4];
13 measure q[5] -> c[5];
14 if(c==5) x q[0];
15 if(c==6) x q[1];
16 if(c==3) x q[2];

```

```

1 OPENQASM 2.0;
2 include "qelib1.inc";
3 qreg q[6];
4 creg c[6];
5 h q[0];
6 h q[1];
7 h q[2];
8 cx q[0],q[3];
9 cx q[1],q[3];
10 cx q[1],q[4];

```

```

11 cx q[2],q[4];
12 cx q[0],q[5];
13 cx q[2],q[5];
14 measure q[3] -> c[3];
15 measure q[4] -> c[4];
16 measure q[5] -> c[5];
17 if(c==5) x q[0];
18 if(c==6) x q[1];
19 if(c==3) x q[2];
20 h q[0];
21 h q[1];
22 h q[2];

```

3.5 State Injection

Description. State injection is the technique for implementing some quantum gates using a dynamic scheme. The basic idea is that the effect of this gate can be implemented by using a special state and a series of gates that can be implemented more simply.

OpenQASM Code. The following gives the circuit and the OpenQASM scripts for the dynamic implementation of the S and T gate [Rya+17].

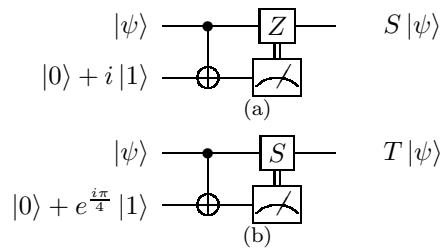

Figure 11: The quantum circuits for state injection, (a) implementation of S gate, (b) implementation of T gate.

```

1 OPENQASM 2.0;
2 include "qelib1.inc";
3 qreg q[2];
4 creg c0[1];
5 creg c1[1];
6 h q[0];
7 h q[0];
8 cx q[0],q[1];
9 measure q[1] -> c1[0];
10 if(c1==1) z q[0];

```

```

1 OPENQASM 2.0;
2 include "qelib1.inc";

```

```

3 qreg q[2];
4 creg c0[1];
5 creg c1[1];
6 h q[0];
7 h q[0];
8 cx q[0], q[1];
9 measure q[1] -> c1[0];
10 if(c1==1) u1(pi/2) q[0];

```

4 Sequential Quantum Circuits

Sequential quantum circuits [LP09; WLY21] are a new breed of quantum circuits that incorporate a clock signal. They can be understood as a generalization of classical (synchronous) logic circuits. From another point of view, sequential quantum circuits are a special type of dynamic quantum circuits, since intermediate measurements are intended to perform at the end of each time step.

Sequential quantum circuits are useful in describing algorithms with loops and quantum feedback, e.g., Repeat-Until-Success circuits [PS14] and quantum walks [Kem03]. In this section, we select some of the examples of sequential quantum circuits and explain how we benchmark them in OpenQASM.

4.1 Repeat-Until-Success

Description. Repeat-Until-Success circuits [PS14] are a bunch of efficient implementations of quantum logic gates which make good use of intermediate measurements as feedback. Figure 12 shows a sequential quantum circuit for repeat-until-success implementation of quantum gate

$$V_3 = \frac{I + 2iZ}{\sqrt{5}}.$$

On this basis, we design several benchmarks.

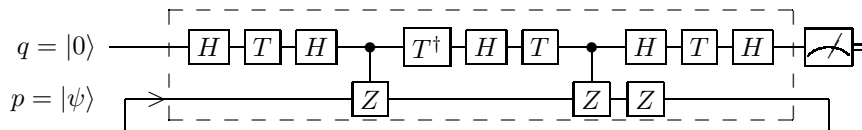

Figure 12: A sequential quantum circuit for repeat-until-success implementation of V_3 . This figure is taken from [WLY21].

OpenQASM Code. In Figure 12, q is the only input variable (qubit) while p is the only internal variable (qubit). At each time step, the qubit q will be measured in the computational basis indicating whether the implementation

succeeds. We abstract the main process of the repeat-until-success implementation of V_3 in OpenQASM as follows.

```

1 def qrus() qubit:q, qubit:p
2 {
3     h q;
4     t q;
5     h q;
6     ctrl @ z q, p;
7     inv @ t q;
8     h q;
9     t q;
10    ctrl @ z q, p;
11    h q;
12    t q;
13    h q;
14    z p;
15    bit result;
16    result = measure q;
17 }

```

Next, we will show how to use the function above to execute the sequential quantum circuit for one time step. Before the main process of the sequential circuit, we need to initialize the internal variable, which is qubit p in our case. The following code sets p to $|+\rangle$.

```

1 qubit p;
2 h p; // p = |+>

```

Every time before calling the function `qrus()`, we need to prepare input qubit q beforehand.

```

1 qubit q;
2 reset q; // q = |0>

```

Now we are ready to call `qrus()`.

```

1 qrus(q, p);

```

After calling `qrus(q, p)`, you can obtain the measurement outcome of the sequential quantum circuit as follows.

```

1 bit x;
2 x = measure q;

```

Here, we note that qubit q has already been measured in the execution of `qrus(p, q)` before that of `x = measure q`. Nevertheless, the measurement outcome is always retrieved from a correct probability distribution. The reason we encapsulate measurements in the main process of the sequential circuit (i.e., `qrus()` in our case) is to ensure that a measurement must be performed at each time step.

4.2 Quantum Walk

Description. Quantum walks [ADZ93; Kem03; Amb+01] are quantum generalizations of classical random walks, and have many applications in quantum algorithms. As an illustrative example (see Figure 13), we consider a quantum walk on a circle (with positions $|0\rangle_p, |1\rangle_p, |2\rangle_p, |3\rangle_p$) with an absorbing boundary $|3\rangle_p$. Here, $Toss$ is the toss operator

$$\begin{aligned} Toss : |0\rangle_c |i\rangle_p &\rightarrow |0\rangle_c |(i+1) \bmod 4\rangle_p, \\ |1\rangle_c |i\rangle_p &\rightarrow |1\rangle_c |(i-1) \bmod 4\rangle_p, \end{aligned}$$

which translates the position conditioned on the coin state.

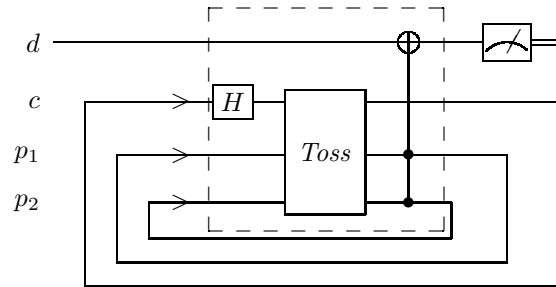

Figure 13: A sequential quantum circuit for quantum walk. This figure is taken from [WLY21].

OpenQASM Code. In Figure 13, d is the only input variable (qubit), and c, p_1, p_2 are the output variables (qubits). The OpenQASM code for the sequential quantum circuit in Figure 13 is as follows.

```

1 OPENQASM 3.0;
2
3 include "stdgates.inc";
4
5 gate coin q
6 {
7     h q;
8 }
9
10 gate shift0 p1, p2
11 {
12     ctrl @ x p2, p1;
13     x p2;
14 }
15
16 gate shift1 p1, p2
17 {

```

```

18     x p2;
19     ctrl @ x p2, p1;
20 }
21
22 gate toss c, p1, p2
23 {
24     x c;
25     ctrl @ shift0 c, p1, p2;
26     x c;
27     ctrl @ shift1 c, p1, p2;
28 }
29
30 def qwalk() qubit:d, qubit:c, qubit:p1, qubit:p2
31 {
32     coin c;
33     toss c, p1, p2;
34     ctrl @ ctrl @ x p1, p2, d;
35     bit result;
36     result = measure d;
37 }

```

Similar to the use of the code in repeat-until-success circuits, after initializing qubit d , a call to `qwalk(d, c, p1, p2)` will result in one step of quantum walk.

4.3 Classical Control

Description. For the convenience to control the behaviour of quantum systems, we consider a class of sequential quantum circuits with their input variables in the computational basis. For example, in Figure 14, the input variables q_1 and q_2 control which kind of quantum gates is performed on p_1, p_2, p_3 . In order to retrieve some information from the sequential quantum circuit, we use a detective qubit (an input variable) d with it being initialized to $|0\rangle$.

OpenQASM Code. The OpenQASM code for the sequential quantum circuit in Figure 14 is as follows.

```

1 OPENQASM 3.0;
2
3 include "stdgates.inc";
4
5 def qctrl() qubit:d, qubit:q1, qubit:q2, qubit:p1, qubit:p2, qubit:p3
6 {
7     ctrl(4) @ x q1, q2, p1, p2, p3;
8     negctrl(2) @ q1, q2, p1;
9     negctrl @ ctrl @ h q1, q2, p2;
10    ctrl @ negctrl @ q1, q2, p3;
11    cx p1, d;
12    bit result[3];
13    result[0] = measure d;
14    result[1] = measure q1;
15    result[2] = measure q2;

```

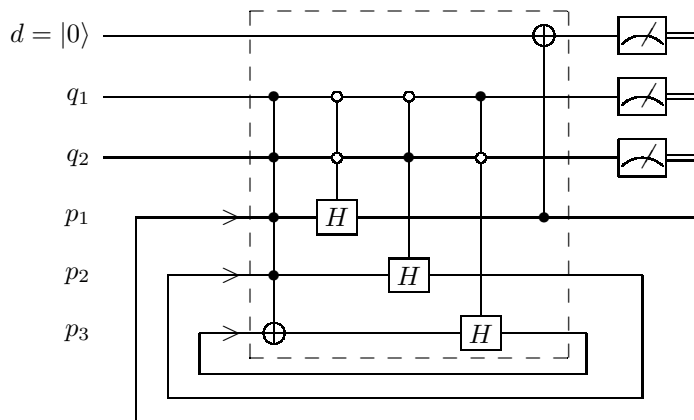

Figure 14: A sequential quantum circuit for classical control. This figure is taken from [WLY21].

16 }

After initializing input variables d, q_1, q_2 , we can call `qctrl(d, q1, q2, d1, d2, d3)` for one time step of the computation.

5 Variational Quantum Circuits

The benchmark on variational quantum circuits (VQCs, or parameterized quantum circuits) aims to provide VQC templates of variational quantum algorithms, including variational quantum eigensolver (VQE).

5.1 Variational Quantum Eigensolver

Description. Solving the ground state energy (minimum eigenvalue) of a Hamiltonian is fundamental in quantum chemistry and condensed matter physics. By using various VQCs to model wavefunctions, VQE converts the minimum eigenvalue problem into optimization over parameters of VQCs. The reader can refer to a review [Til+21] for comprehensive knowledge.

Generation Script. In the benchmark, we provide a Python script named `BenchmarkVQE.py` to generate OpenQASM files for VQCs used in VQE literature. The different types of VQCs (ansatz) we currently support and the corresponding arguments are as follows:

- Hardware-efficient ansatz, `--ansatz hea`.
- Unitary coupled cluster (UCC) ansatz, `--ansatz ucc`.
- Symmetry-preserving ansatz, `--ansatz spa`.

After specifying the ansatz, there are some arguments (e.g., number of qubits) left to set. For detailed usage, please refer to our repository in GitHub.

For example, the following command

```
1 python benchmark_vqe.py --ansatz hea --num_qubits 2
```

will generate an OpenQASM file `output.qasm` for hardware-efficient ansatz with 2 qubits and all parameters randomly.

OpenQASM Code. An example is as follows.

```
1 OPENQASM 2.0;
2 include "qelib.inc";
3
4 qreg qs[2];
5
6 // Rotation
7 rz(2.3528045139656477) qs[0];
8 rx(5.056468340910666) qs[0];
9 rz(4.830262154311054) qs[0];
10 rz(5.826369114279527) qs[1];
11 rx(0.6640310016450327) qs[1];
12 rz(4.350196740814403) qs[1];
13 // Entangling
14 cx qs[0], qs[1];
15 // Rotation
16 rz(1.2300646901838261) qs[0];
17 rx(4.3476867872279685) qs[0];
18 rz(4.04916881465231) qs[0];
19 rz(3.1235589418914618) qs[1];
20 rx(3.5136963947870354) qs[1];
21 rz(2.656998011183734) qs[1];
22 // Entangling
23 cx qs[0], qs[1];
24 // Rotation
25 rz(1.7224607753970849) qs[0];
26 rx(5.561609408659551) qs[0];
27 rz(4.58779861660491) qs[0];
28 rz(6.2727331716861245) qs[1];
29 rx(4.711224351664875) qs[1];
30 rz(4.872654473631725) qs[1];
```

6 Validation

All our benchmark circuits are validated by Qiskit [Qis] and QCOR [Ngu+20]. For OpenQASM 2.0 descriptions, Qiskit is used. To run an example named `in_file.qasm`, simply navigate to its directory and execute the codes in python:

```
1 qc = qiskit.QuantumCircuit.from_qasm_file('./in_file.qasm')
2 simulator = qiskit.Aer.get_backend('aer_simulator')
```

Table 1: Example Applications

Example Applications	Used <i>VeriQBench</i> Benchmark Circuits
Equivalence Checking [BW20b; Hon+21b]	QFT, Grover, Dynamic (Section 3)
Fault Simulation	BV, QFT
Circuit Optimization [Nam+18; AMM14]	QFT, Reversible (Section 2.2)
ATPG [Ber17; CY22]	Grover, BV, QFT, QV
Qubit Mapping [TC20b; TC20a]	Generated Circuits (Section 2.3)
Model Checking [GNP05]	Teleportation

```

3 qc = qiskit.transpile(qc, simulator)
4 result = simulator.run(qc, shots=1, memory=True).result()

```

For OpenQASM 3.0 descriptions, QCOR is used. To run an example named `in_file.qasm`, simply navigate to its directory and execute:

```

1 qcor -shots 1024 in_file.qasm
2 ./a.out

```

The simulation can be accelerated using TNQVM [McC+18], which leverages tensor network theory to simulate quantum circuits. To run the above example with TNQVM acceleration, simply execute:

```

1 qcor -qpu tnqvm[tnqvm-visitor:exatn] -shots 1024 in_file.qasm
2 ./a.out

```

For more details, we refer the readers to the official documentation and user guides [AID].

7 Example Applications

To demonstrate the utility, in this section, we discuss some example applications and point out how the benchmark circuits of *VeriQBench* are used there. A summary of these applications is presented in Table 1.

- *Equivalence Checking of Quantum Circuits*: Equivalence checking is to check if two quantum circuits are functionally equivalent [VMH07; YM10; BW20b; BW20a; Hon+21b; Hon+21a; WLY21]. The circuits for quantum Fourier transform and Grover’s algorithms have been used in work [BW20b] to demonstrate the effectiveness of their equivalence checking methods. Also, the circuits given in Section 3 have been used in testing the algorithm developed in [Hon+21b] for checking equivalence of dynamic quantum circuits, and the circuits such as Bernstein-Vazirani and quantum Fourier transform and quantum volume have been used in the approximate equivalence checking of noisy quantum circuits [Hon+21a].

The circuits given in Section 4 have been used in equivalence checking of sequential quantum circuits [WLY21].

- *Fault Simulation of Quantum Circuits*: Given a quantum circuit and its faulty implementation, fault simulation is to calculate the fidelity between the expected output state and the actually obtained output state [Hua+21; Che+21; Isa+21; Hua]. The work is performed on combinational quantum circuits, including Bernstein-Vazirani and Quantum Fourier Transform with realistic fault models proposed in [Hsi+20].
- *Circuit Optimization*: Quantum circuit optimization [Mas+08; Pra+06; SM13; AMM14; Nam+18] aims to reduce the complexity of a quantum circuit, where the complexity, depending on the scenario, can be quantified by the size, depth, T-count or T-depth of the quantum circuit. The reversible circuits such as divisibility checkers have been used to benchmark the quantum circuit optimization algorithms [Nam+18; AMM14].
- *Automatic Test Pattern Generation (ATPG)*: Quantum ATPG algorithms [PPH12; Ber17; CY22] aim to generate specific test patterns based on the structure and fault model of the quantum circuit, where the test patterns include a set of input vectors and corresponding outputs vectors. The Combinational Quantum Circuits including Grover’s algorithm, Bernstein-Vazirani, Quantum Fourier Transform and Quantum Volume with the unitary fault model have been used to demonstrate the effectiveness of the ATPG algorithms in [Ber17; CY22].
- *Qubit Mapping*: The target of qubit mapping is to assign a physical qubit on a quantum chip to every logical qubit in a quantum circuit, while optimizing the performance of the circuit [Mas+08; SSP14; LSJ14; WLD14; PS16; Sir+18; ZPW18; CSU19; WBZ19; LDX19; Bha+19; Mur+19; TQ19; Siv+20]. One of the most important performance metrics of quantum circuits is the depth of the circuit. The method for generating qubit mapping problems with optimal solutions for depth in this benchmark was proposed in [TC20b], and was used to evaluate the qubit mapping tools in [TC20a].
- *Model Checking Quantum Systems*: Model-checking is one of the most successful verification techniques with numerous applications in hardware and software industries. It has been generalised to check various properties of quantum systems, including quantum cryptographic protocols [GNP08], quantum programs [YF21] and quantum circuits [Yin21]. The teleportation circuit in Section 3.1 has been used in probabilistic model checking algorithm of quantum protocols [GNP05].

Acknowledgments

We would like to thank Zhicheng Zhang, Minbo Gao and Riling Li for their insightful discussions. This work was partly supported by the National Key

R&D Program of China (Grant No: 2018YFA0306701), the National Natural Science Foundation of China (Grant No: 61832015).

References

- [AD16] Nabila Abdessaied and Rolf Drechsler. “Reversible and Quantum Circuits”. In: *Google Scholar Google Scholar Digital Library Digital Library* (2016).
- [ADZ93] Y. Aharonov, L. Davidovich, and N. Zagury. “Quantum random walks”. In: *Physical Review A* 48.2 (1993), p. 1687. DOI: 10.1103/PhysRevA.48.1687.
- [AG04] Scott Aaronson and Daniel Gottesman. “Improved simulation of stabilizer circuits”. In: *Physical Review A* 70.5 (2004), p. 052328.
- [AID] AIDE-QC. *AIDE-QC: Documentation and User Guides*. <https://aide-qc.github.io/deploy/>.
- [Amb+01] A. Ambainis et al. “One-dimensional quantum walks”. In: *Proceedings of the Thirty-Third Annual ACM Symposium on Theory of Computing*. 2001, pp. 37–49. DOI: 10.1145/380752.380757.
- [AMM14] Matthew Amy, Dmitri Maslov, and Michele Mosca. “Polynomial-time T-depth optimization of Clifford+ T circuits via matroid partitioning”. In: *IEEE Transactions on Computer-Aided Design of Integrated Circuits and Systems* 33.10 (2014), pp. 1476–1489.
- [Aru+19] Frank Arute et al. “Quantum supremacy using a programmable superconducting processor”. In: *Nature* 574.7779 (2019), pp. 505–510.
- [Ben+93] Charles H Bennett et al. “Teleporting an unknown quantum state via dual classical and Einstein-Podolsky-Rosen channels”. In: *Physical review letters* 70.13 (1993), p. 1895.
- [Ber17] Debajyoti Bera. “Detection and diagnosis of single faults in quantum circuits”. In: *IEEE Transactions on Computer-Aided Design of Integrated Circuits and Systems* 37.3 (2017), pp. 587–600.
- [Bha+19] Debjyoti Bhattacharjee et al. “MUQUT: Multi-constraint quantum circuit mapping on NISQ computers”. In: *2019 IEEE/ACM International Conference on Computer-Aided Design (ICCAD)*. IEEE, 2019, pp. 1–7.
- [BM21] Sergey Bravyi and Dmitri Maslov. “Hadamard-free circuits expose the structure of the Clifford group”. In: *IEEE Transactions on Information Theory* 67.7 (2021), pp. 4546–4563.
- [Boi+18] Sergio Boixo et al. “Characterizing quantum supremacy in near-term devices”. In: *Nature Physics* 14.6 (2018), pp. 595–600.

- [Bra+21] Sergey Bravyi et al. “Clifford circuit optimization with templates and symbolic pauli gates”. In: *arXiv preprint arXiv:2105.02291* (2021).
- [Bro+20] Michael Broughton et al. “Tensorflow quantum: A software framework for quantum machine learning”. In: *arXiv preprint arXiv:2003.02989* (2020).
- [BV97] Ethan Bernstein and Umesh Vazirani. “Quantum complexity theory”. In: *SIAM Journal on Computing* 26.5 (1997), pp. 1411–1473.
- [BW20a] Lukas Burgholzer and Robert Wille. “Advanced equivalence checking for quantum circuits”. In: *IEEE Transactions on Computer-Aided Design of Integrated Circuits and Systems* 40.9 (2020), pp. 1810–1824.
- [BW20b] Lukas Burgholzer and Robert Wille. “Improved DD-based equivalence checking of quantum circuits”. In: *2020 25th Asia and South Pacific Design Automation Conference (ASP-DAC)*. IEEE, 2020, pp. 127–132.
- [Cer+21] Marco Cerezo et al. “Variational quantum algorithms”. In: *Nature Reviews Physics* 3.9 (2021), pp. 625–644.
- [Che+21] Song Cheng et al. “Simulating noisy quantum circuits with matrix product density operators”. In: *Phys. Rev. Research* 3 (2 Apr. 2021), p. 023005. DOI: 10.1103/PhysRevResearch.3.023005. URL: <https://link.aps.org/doi/10.1103/PhysRevResearch.3.023005>.
- [Chi17] Andrew M Childs. “Lecture notes on quantum algorithms”. In: *Lecture notes at University of Maryland* (2017).
- [Cór+21] Antonio D Córcoles et al. “Exploiting dynamic quantum circuits in a quantum algorithm with superconducting qubits”. In: *Physical Review Letters* 127.10 (2021), p. 100501.
- [Cro+19] Andrew W Cross et al. “Validating quantum computers using randomized model circuits”. In: *Physical Review A* 100.3 (2019), p. 032328.
- [CS08] Amlan Chakrabarti and Susmita Sur-Kolay. “Designing quantum adder circuits and evaluating their error performance”. In: *2008 International Conference on Electronic Design*. 2008, pp. 1–6. DOI: 10.1109/ICED.2008.4786689.
- [CSU19] Andrew M Childs, Eddie Schoute, and Cem M Unsal. “Circuit transformations for quantum architectures”. In: *arXiv preprint arXiv:1902.09102* (2019).
- [CY22] Kean Chen and Mingsheng Ying. “Automatic Test Pattern Generation for Robust Quantum Circuit Testing”. In: *arXiv preprint arXiv:2202.10697* (2022).

- [DL21] Yulong Dong and Lin Lin. “Random circuit block-encoded matrix and a proposal of quantum LINPACK benchmark”. In: *Physical Review A* 103.6 (2021), p. 062412.
- [FGG14] Edward Farhi, Jeffrey Goldstone, and Sam Gutmann. “A quantum approximate optimization algorithm”. In: *arXiv preprint arXiv:1411.4028* (2014).
- [GN96] Robert B Griffiths and Chi-Sheng Niu. “Semiclassical Fourier transform for quantum computation”. In: *Physical Review Letters* 76.17 (1996), p. 3228.
- [GNP05] Simon Gay, Rajagopal Nagarajan, and Nikolaos Papanikolaou. “Probabilistic Model-Checking of Quantum Protocols”. In: *arXiv preprint quant-ph/0504007* (2005).
- [GNP08] Simon J Gay, Rajagopal Nagarajan, and Nikolaos Papanikolaou. “QMC: A model checker for quantum systems”. In: *International Conference on Computer Aided Verification*. Springer. 2008, pp. 543–547.
- [Gro96] Lov K Grover. “A fast quantum mechanical algorithm for database search”. In: *Proceedings of the twenty-eighth annual ACM symposium on Theory of computing*. 1996, pp. 212–219.
- [Had+19] Stuart Hadfield et al. “From the quantum approximate optimization algorithm to a quantum alternating operator ansatz”. In: *Algorithms* 12.2 (2019), p. 34.
- [Hon+21a] Xin Hong et al. “Approximate equivalence checking of noisy quantum circuits”. In: *2021 58th ACM/IEEE Design Automation Conference (DAC)*. IEEE. 2021, pp. 637–642.
- [Hon+21b] Xin Hong et al. “Equivalence Checking of Dynamic Quantum Circuits”. In: *arXiv preprint arXiv:2106.01658* (2021).
- [Hsi+20] Cheng-Yun Hsieh et al. “Realistic Fault Models and Fault Simulation for Quantum Dot Quantum Circuits”. In: *2020 57th ACM/IEEE Design Automation Conference (DAC)*. 2020, pp. 1–6. DOI: 10.1109/DAC18072.2020.9218573.
- [Hua] Mingyu Huang. *Fault Simulation Repository*. <https://github.com/hmy98213/Fault-Simulation>.
- [Hua+21] Yipeng Huang et al. “Logical Abstractions for Noisy Variational Quantum Algorithm Simulation”. In: *Proceedings of the 26th ACM International Conference on Architectural Support for Programming Languages and Operating Systems*. ASPLOS 2021. Virtual, USA: Association for Computing Machinery, 2021, pp. 456–472. ISBN: 9781450383172. DOI: 10.1145/3445814.3446750. URL: <https://doi.org/10.1145/3445814.3446750>.

- [Isa+21] Sergei V. Isakov et al. *Simulations of Quantum Circuits with Approximate Noise using qsim and Cirq*. 2021. DOI: 10.48550/ARXIV.2111.02396. URL: <https://arxiv.org/abs/2111.02396>.
- [Kem03] J. Kempe. “Quantum random walks: an introductory overview”. In: *Contemporary Physics* 44.4 (2003), pp. 307–327. DOI: 10.1080/00107151031000110776.
- [LDX19] Gushu Li, Yufei Ding, and Yuan Xie. “Tackling the qubit mapping problem for NISQ-era quantum devices”. In: *Proceedings of the Twenty-Fourth International Conference on Architectural Support for Programming Languages and Operating Systems*. 2019, pp. 1001–1014.
- [Li+20a] Ang Li et al. “Qasmbench: A low-level qasm benchmark suite for nisq evaluation and simulation”. In: *arXiv preprint arXiv:2005.13018* (2020).
- [Li+20b] Gushu Li et al. “Projection-based runtime assertions for testing and debugging quantum programs”. In: *Proceedings of the ACM on Programming Languages* 4.OOPSLA (2020), pp. 1–29.
- [Liu+21] Yunchao Liu et al. “Benchmarking near-term quantum computers via random circuit sampling”. In: *arXiv preprint arXiv:2105.05232* (2021).
- [LP09] M. Lukac and M. Perkowski. “Quantum Finite State Machines as Sequential Quantum Circuits”. In: *Proceedings of the 39th International Symposium on Multiple-Valued Logic*. 2009, pp. 92–97. DOI: 10.1109/ISMVL.2009.46.
- [LSJ14] Chia-Chun Lin, Susmita Sur-Kolay, and Niraj K Jha. “PAQCS: Physical design-aware fault-tolerant quantum circuit synthesis”. In: *IEEE Transactions on Very Large Scale Integration (VLSI) Systems* 23.7 (2014), pp. 1221–1234.
- [Mas] Dmitri Maslov. *Reversible Logic Synthesis Benchmarks Page*. <https://reversiblebenchmarks.github.io>.
- [Mas+08] Dmitri Maslov et al. “Quantum circuit simplification and level compaction”. In: *IEEE Transactions on Computer-Aided Design of Integrated Circuits and Systems* 27.3 (2008), pp. 436–444.
- [McC+18] Alexander McCaskey et al. “Validating quantum-classical programming models with tensor network simulations”. In: *PLOS ONE* 13.12 (Dec. 2018), pp. 1–19. DOI: 10.1371/journal.pone.0206704. URL: <https://doi.org/10.1371/journal.pone.0206704>.
- [Mur+19] Prakash Murali et al. “Full-stack, real-system quantum computer studies: Architectural comparisons and design insights”. In: *2019 ACM/IEEE 46th Annual International Symposium on Computer Architecture (ISCA)*. IEEE. 2019, pp. 527–540.

- [Nam+18] Yunseong Nam et al. “Automated optimization of large quantum circuits with continuous parameters”. In: *npj Quantum Information* 4.1 (2018), pp. 1–12.
- [NC02] Michael A Nielsen and Isaac Chuang. *Quantum computation and quantum information*. 2002.
- [Ngu+20] Thien Nguyen et al. “Extending C++ for Heterogeneous Quantum-Classical Computing”. In: *arXiv e-prints*, arXiv:2010.03935 (Oct. 2020), arXiv:2010.03935. arXiv: 2010.03935 [quant-ph].
- [Per+14] Alberto Peruzzo et al. “A variational eigenvalue solver on a photonic quantum processor”. In: *Nature communications* 5.1 (2014), pp. 1–7.
- [PPH12] Alexandru Paler, Ilia Polian, and John P Hayes. “Detection and diagnosis of faulty quantum circuits”. In: *17th Asia and South Pacific Design Automation Conference*. IEEE. 2012, pp. 181–186.
- [Pra+06] Aditya K Prasad et al. “Data structures and algorithms for simplifying reversible circuits”. In: *ACM Journal on Emerging Technologies in Computing Systems (JETC)* 2.4 (2006), pp. 277–293.
- [PS14] A. Paetznick and K. M. Svore. “Repeat-until-success: non-deterministic decomposition of single-qubit unitaries”. In: *Quantum Information & Computation* 14.15–16 (2014), pp. 1277–1301. DOI: 10.26421/QIC14.15-16-2.
- [PS16] Massoud Pedram and Alireza Shafaei. “Layout optimization for quantum circuits with linear nearest neighbor architectures”. In: *IEEE Circuits and Systems Magazine* 16.2 (2016), pp. 62–74.
- [Qis] Qiskit. *Qiskit*. <https://qiskit.org>.
- [Rya+17] Colm A Ryan et al. “Hardware for dynamic quantum computing”. In: *Review of Scientific Instruments* 88.10 (2017), p. 104703.
- [Sir+18] Marcos Yukio Siraichi et al. “Qubit allocation”. In: *Proceedings of the 2018 International Symposium on Code Generation and Optimization*. 2018, pp. 113–125.
- [Siv+20] Seyon Sivarajah et al. “t—ket_i: a retargetable compiler for NISQ devices”. In: *Quantum Science and Technology* 6.1 (2020), p. 014003.
- [SM13] Mehdi Saeedi and Igor L Markov. “Synthesis and optimization of reversible circuits—a survey”. In: *ACM Computing Surveys (CSUR)* 45.2 (2013), pp. 1–34.
- [SSP14] Alireza Shafaei, Mehdi Saeedi, and Massoud Pedram. “Qubit placement to minimize communication overhead in 2D quantum architectures”. In: *2014 19th Asia and South Pacific Design Automation Conference (ASP-DAC)*. IEEE. 2014, pp. 495–500.

- [TC20a] Bochen Tan and Jason Cong. “Optimal layout synthesis for quantum computing”. In: *2020 IEEE/ACM International Conference On Computer Aided Design (ICCAD)*. IEEE. 2020, pp. 1–9.
- [TC20b] Bochen Tan and Jason Cong. “Optimality study of existing quantum computing layout synthesis tools”. In: *IEEE Transactions on Computers* 70.9 (2020), pp. 1363–1373.
- [Til+21] Jules Tilly et al. *The Variational Quantum Eigensolver: a review of methods and best practices*. 2021. arXiv: 2111.05176 [quant-ph].
- [Tom+22] Teague Tomesh et al. “SupermarQ: A Scalable Quantum Benchmark Suite”. In: *arXiv preprint arXiv:2202.11045* (2022).
- [TQ19] Swamit S Tannu and Moinuddin K Qureshi. “Not all qubits are created equal: a case for variability-aware policies for NISQ-era quantum computers”. In: *Proceedings of the Twenty-Fourth International Conference on Architectural Support for Programming Languages and Operating Systems*. 2019, pp. 987–999.
- [VMH07] George F Viamontes, Igor L Markov, and John P Hayes. “Checking equivalence of quantum circuits and states”. In: *2007 IEEE/ACM International Conference on Computer-Aided Design*. IEEE. 2007, pp. 69–74.
- [WBZ19] Robert Wille, Lukas Burgholzer, and Alwin Zulehner. “Mapping quantum circuits to IBM QX architectures using the minimal number of SWAP and H operations”. In: *2019 56th ACM/IEEE Design Automation Conference (DAC)*. IEEE. 2019, pp. 1–6.
- [WLD14] Robert Wille, Aaron Lye, and Rolf Drechsler. “Optimal SWAP gate insertion for nearest neighbor quantum circuits”. In: *2014 19th Asia and South Pacific Design Automation Conference (ASPDAC)*. IEEE. 2014, pp. 489–494.
- [WLY21] Q. Wang, R. Li, and M. Ying. “Equivalence Checking of Sequential Quantum Circuits”. In: *IEEE Transactions on Computer-Aided Design of Integrated Circuits and Systems* (2021), Early Access. DOI: 10.1109/TCAD.2021.3117506.
- [YF21] Mingsheng Ying and Yuan Feng. *Model Checking Quantum Systems: Principles and Algorithms*. Cambridge University Press, 2021.
- [Yin21] Mingsheng Ying. “Model Checking for Verification of Quantum Circuits”. In: *International Symposium on Formal Methods*. Springer. 2021, pp. 23–39.
- [YM10] Shigeru Yamashita and Igor L Markov. “Fast equivalence-checking for quantum circuits”. In: *2010 IEEE/ACM International Symposium on Nanoscale Architectures*. IEEE. 2010, pp. 23–28.

- [ZPW18] Alwin Zulehner, Alexandru Paler, and Robert Wille. “An efficient methodology for mapping quantum circuits to the IBM QX architectures”. In: *IEEE Transactions on Computer-Aided Design of Integrated Circuits and Systems* 38.7 (2018), pp. 1226–1236.