

MINIMAL PRESENTATIONS OF GLN-WEB CATEGORIES

GENTA LATIFI AND DANIEL TUBBENHAUER

ABSTRACT. In this paper we study categories of \mathfrak{gl}_n -webs which describe associated representation categories of the quantum group $U_q(\mathfrak{gl}_n)$. We give a minimal presentation of the category of \mathfrak{gl}_n -webs over a field with generic quantum parameters. We additionally describe an integral presentation which differs from others in the literature because it is “as coefficient-free as possible”.

CONTENTS

| | |
|--|----|
| 1. Introduction | 1 |
| 2. Web categories | 3 |
| 2A. Definition of web categories | 3 |
| 2B. Properties of webs | 10 |
| 2C. A basis for thin webs | 19 |
| 2D. Exterior and red-green webs | 21 |
| 3. Equivalence Theorem | 21 |
| 3A. The quantum general linear group and its idempotented form | 21 |
| 3B. Quantum symmetric Howe functors | 23 |
| 3C. The functor Γ_{sym} | 24 |
| 3D. Relating the two web categories | 25 |
| 3E. Proof that Γ_{sym} is an equivalence of categories | 26 |
| 4. Minimality Theorem | 28 |
| 5. Some other properties of webs | 30 |
| References | 36 |

1. INTRODUCTION

In this paper we study a category of planar graphs coloured by non-negative integers, called a web category. Web categories, in various incarnations, are around for donkey’s years.

One of the classical examples of diagrammatic categories is the Temperley–Lieb category, denoted by \mathcal{TL} . It was independently introduced by Rumer–Teller–Weyl in their study of invariant tensors and by Temperley–Lieb statistical mechanics.

Let q be a generic formal parameter and let $\mathbb{C}(q)$ be the field of rational functions in q . The category \mathcal{TL} is the $\mathbb{C}(q)$ -linear category with objects being non-negative integers $k \in \mathbb{Z}_{\geq 0}$, and the morphisms are generated by (taking tensor products \otimes and compositions \circ and $\mathbb{C}(q)$ -linear extensions) of the non-intersecting planar diagrams of the form



subject to the relation

$$\bigcirc_1 = -[2],$$

where $[2] = q + q^{-1}$. The compositions and tensor products of diagrams are illustrated below:
 OLD: $[2] = q + q^{-1}$ and compositions and tensor products of diagrams are illustrated below

$$\cap \circ \cup = \bigcirc, \quad | \otimes \cap = | \cap.$$

Let $U_q(\mathfrak{sl}_2)$ be the quantum special linear group. Let $U_q(\mathfrak{sl}_2)\text{-fdMod}_\Lambda = U_q(\mathfrak{sl}_2)\text{-fdMod}_S$ be the full subcategory of finite-dimensional $U_q(\mathfrak{sl}_2)$ -modules generated by tensor products of the two-dimensional vector representation $\mathbb{C}_q^2 = \mathbb{C}(q)^2$ of $U_q(\mathfrak{sl}_2)$. From the work of Rumer, Teller, and Weyl in [RTW32], it follows that \mathcal{TL} describes $U_q(\mathfrak{sl}_2)\text{-fdMod}_\Lambda$. More precisely, we have the following.

Theorem 1.1. (Rumer–Teller–Weyl [RTW32].) *The category \mathcal{TL} and $U_q(\mathfrak{sl}_2)\text{-fdMod}_\Lambda$ are equivalent as pivotal categories.*

It follows from this theorem that the additive Karoubi closure of \mathcal{TL} recovers all of $U_q(\mathfrak{sl}_2)\text{-fdMod}$.

Generalizing these ideas, Kuperberg [Kup96] gave a diagrammatic description of $U_q(\mathfrak{sl}_3)\text{-fdMod}_\Lambda$, the full subcategory of finite-dimensional $U_q(\mathfrak{sl}_3)$ -modules whose objects are finite tensor products of $\bigwedge_q^k \mathbb{C}_q^3$, the fundamental $U_q(\mathfrak{sl}_3)$ -modules. As for the Temperley–Lieb case, taking the additive Karoubi closure of Kuperberg’s web category describes the entire category $U_q(\mathfrak{sl}_3)\text{-fdMod}$.

Generalising Kuperberg’s result to $U_q(\mathfrak{sl}_n)\text{-fdMod}_\Lambda$, was an open problem for quite a while, but some partial answers were known before. The question was then fully answered by Cautis, Kamnitzer, Morrison in [CKM14].

Similar questions were than addressed in many works, e.g. in [RT16] which studies symmetric powers instead of exterior powers.

In this paper we study the category $\mathbf{SWeb}_{\uparrow, \downarrow}(\mathfrak{gl}_n)$ of \mathfrak{gl}_n -webs, whose objects are words from $\{k_\uparrow, k_\downarrow \mid k \in \mathbb{Z}_{\geq 0}\}$. We say that the object k_\uparrow is upward oriented and k_\downarrow is downward oriented. A (finite) word in these symbols is denoted by a vector arrow \vec{k} . Then a morphism from \vec{k} to \vec{l} , called a web, is a planar diagram with bottom boundary \vec{k} and top boundary \vec{l} , which is obtained by piecing together any of the generating diagrams:

$$(1.2) \quad \begin{array}{cccccccc} \begin{array}{c} k+l \\ \diagup \quad \diagdown \\ \diagdown \quad \diagup \\ k \quad l \end{array}, & \begin{array}{c} k \quad l \\ \diagdown \quad \diagup \\ \diagup \quad \diagdown \\ k+l \end{array}, & \begin{array}{c} k+l \\ \diagup \quad \diagdown \\ \diagdown \quad \diagup \\ k \quad l \end{array}, & \begin{array}{c} k \quad l \\ \diagdown \quad \diagup \\ \diagup \quad \diagdown \\ k+l \end{array}, & \begin{array}{c} k \quad k \\ \diagup \quad \diagdown \\ \diagdown \quad \diagup \\ k \quad k \end{array}, & \begin{array}{c} \quad \quad \\ \diagdown \quad \diagup \\ \diagup \quad \diagdown \\ k \quad k \end{array}, & \begin{array}{c} k \quad k \\ \diagup \quad \diagdown \\ \diagdown \quad \diagup \\ k \quad k \end{array}, & \begin{array}{c} \quad \quad \\ \diagdown \quad \diagup \\ \diagup \quad \diagdown \\ k \quad k \end{array} \end{array}$$

Here, “piecing together” means gluing a diagram w_2 on top of another diagram w_1 (which will correspond to a composition of diagrams $w_2 \circ w_1$) and putting a diagram w_2 to the right of a diagram w_1 (which will correspond to a tensor product $w_1 \otimes w_2$). For example,

$$\begin{array}{c} 1 \\ \diagup \quad \diagdown \\ \diagdown \quad \diagup \\ 3 \quad 1 \\ \diagdown \quad \diagup \\ 2 \quad 1 \end{array} \begin{array}{c} \quad \quad \\ \diagdown \quad \diagup \\ \diagup \quad \diagdown \\ 2 \quad 2 \end{array} = \left(\begin{array}{c} 1 \\ | \\ 1 \end{array} \otimes \begin{array}{c} 2 \\ \diagdown \quad \diagup \\ \diagup \quad \diagdown \\ 2 \quad 2 \end{array} \right) \circ \left(\begin{array}{c} 1 \quad 2 \\ \diagdown \quad \diagup \\ \diagup \quad \diagdown \\ 3 \quad 2 \end{array} \otimes \begin{array}{c} 2 \\ | \\ 2 \end{array} \right) \circ \left(\begin{array}{c} 3 \quad 2 \\ \diagdown \quad \diagup \\ \diagup \quad \diagdown \\ 2 \quad 1 \end{array} \otimes \begin{array}{c} 2 \\ | \\ 2 \end{array} \right)$$

is a morphism from $\vec{k} = 2_\uparrow \otimes 1_\uparrow \otimes 2_\downarrow$ to $\vec{l} = 1_\uparrow$. As we will explain, this category of \mathfrak{gl}_n -webs describes in a “minimal” way (following Turaev’s minimal presentation of the tangle categories [Tur89]; see also [BDK20] which served as a motivation for us), the entire category of finite-dimensional $U_q(\mathfrak{gl}_n)$ -modules.

The paper is organized as follows. We first start the full subcategory $U_q(\mathfrak{gl}_n)\text{-fdMod}_{S, S^*}$ generated by tensor products of symmetric powers $\text{Sym}_q^k \mathbb{C}_q^n$ ($k \in \mathbb{N}$) of the standard $U_q(\mathfrak{gl}_n)$ -representation and their duals. We point out here that in contrast to [CKM14], where $(\bigwedge_q^k \mathbb{C}_q^n)^* \cong \bigwedge_q^{n-k} \mathbb{C}_q^n$, we do not have such an isomorphism in the case of symmetric powers. Moreover, we explain that we have described the category of representations in a minimal way, namely that

we have used a minimal set of generators (only those webs in Equation 1.2 with $k = 1$ or $l = 1$) and a minimal set of defining relations for the web category to describe the category of modules.

Finally, we give an integral presentation of \mathfrak{gl}_n -webs which is different from the ones in the literature. Whether this integral presentation also describes $U_q(\mathfrak{gl}_n)\text{-fdMod}_{S,S^*}$ is an open problem, but we show that our web category surjects onto this category.

Acknowledgements. We would like to thank Anna Beliakova, Sasha Kleshchev, Catharina Stroppel and Emmanuel Wagner for freely sharing ideas, patiently answering questions and helpful discussions.

G.L. would like to thank MSRI for sponsoring a research stay during the program Quantum Symmetries where parts of the mathematics in this paper was discovered.

This paper is part of the first authors Ph.D. thesis at the Universität Zürich, and the support of the Universität Zürich during the years is gratefully acknowledged. None of us are at the University Zürich anymore, but it was a great time!

2. WEB CATEGORIES

We use the following conventions for quantum numbers. Let $s \in \mathbb{Z}$ and $t \in \mathbb{Z}_{\geq 0}$. By convention, $[0]! = 1 = \begin{bmatrix} s \\ 0 \end{bmatrix}$ and

$$[s] = \frac{q^s - q^{-s}}{q - q^{-1}}, \quad [t]! = [t][t-1] \dots [1], \quad \begin{bmatrix} s \\ t \end{bmatrix} = \frac{[s][s-1] \dots [s-t+1]}{[t][t-1] \dots [1]}.$$

We define here also the *quantum trinomial coefficient* via

$$\begin{bmatrix} a \\ b, c \end{bmatrix} := \frac{[a][a-1] \dots [a-b-c+1]}{[b]![c]}.$$

Fix a non-negative integer n . This integer will be fixed here and throughout. Let \mathbb{k} be any field. Let $\mathbb{k}(q^{\frac{1}{n}})$ be the field of rational functions over $q^{\frac{1}{n}}$, where q is chosen such that all quantum numbers are invertible in $\mathbb{k}(q^{\frac{1}{n}})$. (For example, q could be a generic parameter.)

Remark 2.1. The n th root of q is only needed to match the braidings on webs with the braiding coming from the R -matrix, see Theorem 3D.1. The n th root does not play any other role.

2A. Definition of web categories.

Definition 2A.1. The *free thin symmetric upward pointing category* of \mathfrak{gl}_n -webs, denoted by $\mathbf{fSWeb}_{\uparrow}(\mathfrak{gl}_n)$, is the $\mathbb{k}(q^{\frac{1}{n}})$ -linear category monoidally generated by

- objects $\{k_{\uparrow} \mid k \in \mathbb{Z}_{\geq 0}\}$,
- morphisms

$$\begin{array}{c} k+1 \\ \diagup \quad \diagdown \\ \diagdown \quad \diagup \\ k \quad 1 \end{array} : k_{\uparrow} \otimes 1_{\uparrow} \rightarrow (k+1)_{\uparrow}, \quad \begin{array}{c} k \quad 1 \\ \diagdown \quad \diagup \\ \diagup \quad \diagdown \\ k+1 \end{array} : (k+1)_{\uparrow} \rightarrow k_{\uparrow} \otimes 1_{\uparrow},$$

called thin merges (or $(k, 1)$ -merges) and thin splits (or $(k, 1)$ -splits), respectively.

Here and throughout, we will use the conventions of [RT16] for reading the diagrams, meaning that $v \circ u$ is obtained by gluing v on top of u and $u \otimes v$ is obtained by putting v to the right of u , for $u, v \in \text{Hom}_{\mathbf{fSWeb}_{\uparrow}(\mathfrak{gl}_n)}(\vec{k}, \vec{l})$. For example,

$$\begin{array}{c} \text{cap} \\ k \quad k \end{array} \circ \begin{array}{c} \text{cup} \\ k \quad k \end{array} = \text{circle } k, \quad \begin{array}{c} \text{cup} \\ k \quad k \end{array} \circ \begin{array}{c} \text{cap} \\ k \quad k \end{array} = \begin{array}{c} k \quad k \\ \diagdown \quad \diagup \\ \diagup \quad \diagdown \\ k \quad k \end{array}, \quad \begin{array}{c} l_1 \quad l_2 \\ \diagdown \quad \diagup \\ \diagup \quad \diagdown \\ k_1 \quad k_2 \end{array} \otimes \begin{array}{c} k_3 \\ \text{line} \\ k_3 \end{array} = \begin{array}{c} l_1 \quad l_2 \quad k_3 \\ \diagdown \quad \diagup \quad \text{line} \\ \diagup \quad \diagdown \quad \text{line} \\ k_1 \quad k_2 \quad k_3 \end{array}$$

where in the final equation $k_1 + k_2 = l_1 + l_2$. The cup and cap diagrams will be defined later on. Moreover, here we have omitted the arrows, meaning that these conventions hold for all orientations (we elaborate on orientations below).

We want to consider a certain quotient of $\mathbf{fSWeb}_\uparrow(\mathfrak{gl}_n)$. We therefore need to define some other webs. We will later impose a (co)associativity relation on the webs, see [Equation 2A.8](#). For now we proceed as follows.

Definition 2A.2. The *thin over-crossing* and *thin under-crossing* are defined respectively as

$$\begin{array}{c} 1 \\ \nearrow \\ 1 \end{array} \begin{array}{c} 1 \\ \searrow \\ 1 \end{array} = -q^{-1-\frac{1}{n}} \left(\begin{array}{c} 1 \\ | \\ 1 \end{array} \begin{array}{c} 1 \\ | \\ 1 \end{array} - q \begin{array}{c} 1 \quad 1 \\ \diagdown \quad \diagup \\ 2 \\ \diagup \quad \diagdown \\ 1 \quad 1 \end{array} \right),$$

$$\begin{array}{c} 1 \\ \searrow \\ 1 \end{array} \begin{array}{c} 1 \\ \nearrow \\ 1 \end{array} = -q^{1+\frac{1}{n}} \left(\begin{array}{c} 1 \\ | \\ 1 \end{array} \begin{array}{c} 1 \\ | \\ 1 \end{array} - q^{-1} \begin{array}{c} 1 \quad 1 \\ \diagdown \quad \diagup \\ 2 \\ \diagup \quad \diagdown \\ 1 \quad 1 \end{array} \right).$$

Definition 2A.3. The *thick over-crossing of type (k, l)* is defined by “exploding” edges:

$$\begin{array}{c} l \\ \nearrow \\ k \end{array} \begin{array}{c} k \\ \searrow \\ l \end{array} = \frac{1}{[k]!} \frac{1}{[l]!} \begin{array}{c} l \quad k \\ \diagdown \quad \diagup \\ \text{explosion} \\ \diagup \quad \diagdown \\ k \quad l \end{array}.$$

Similarly we define the thick under-crossing. By definition, if $k = 0$ or $l = 0$ then the crossing is the corresponding identity.

Definition 2A.4. We define the $(1, k)$ -merges as

$$\begin{array}{c} k+1 \\ | \\ \text{merge} \\ 1 \quad k \end{array} = q^{\frac{k}{n}-k} \begin{array}{c} k+1 \\ | \\ \text{merge} \\ 1 \quad k \end{array},$$

and similarly the $(1, k)$ -splits.

The scalar in the above definition is needed for [Lemma 2B.17](#) to work. Further, we will also need the following.

Definition 2A.5. The *thick merge of type (k, l)* (or the (k, l) -merge) is defined as below

$$\begin{array}{c} k+l \\ | \\ \text{merge} \\ k \quad l \end{array} = \frac{1}{[l]!} \begin{array}{c} k+l \\ | \\ \text{merge} \\ k \quad l \end{array}$$

and similarly the (k, l) -split.

The meticulous reader observes that [Definition 2A.3](#) and [Definition 2A.5](#) are not well-defined since we have not specified the precise form of the webs. However, in [Remark 2A.11](#) we will explain that this is not a problem, so the concerned reader might choose any form of these webs. Similarly for the other web categories that we define later.

Definition 2A.6. The $F^{(j)}$ and $E^{(j)}$ -ladders are given by

$$\begin{array}{c} k-j \quad l+j \\ \uparrow \quad \uparrow \\ \text{---} \xrightarrow{j} \text{---} \\ \uparrow \quad \uparrow \\ k \quad l \\ F^{(j)} \end{array} = \begin{array}{c} k-j \quad l+j \\ \uparrow \quad \uparrow \\ \text{---} \text{---} \\ \uparrow \quad \uparrow \\ k \quad l \end{array} \quad \text{and} \quad \begin{array}{c} k+j \quad l-j \\ \uparrow \quad \uparrow \\ \text{---} \xleftarrow{j} \text{---} \\ \uparrow \quad \uparrow \\ k \quad l \\ E^{(j)} \end{array} = \begin{array}{c} k+j \quad l-j \\ \uparrow \quad \uparrow \\ \text{---} \text{---} \\ \uparrow \quad \uparrow \\ k \quad l \end{array} .$$

Now we are ready to define the aforementioned quotient of $\mathbf{fSWeb}_\uparrow(\mathfrak{gl}_n)$.

Definition 2A.7. The *thin symmetric upward pointing category* of \mathfrak{gl}_n -webs, that we denote by $\mathbf{SWeb}_\uparrow(\mathfrak{gl}_n)$, is obtained from $\mathbf{fSWeb}_\uparrow(\mathfrak{gl}_n)$ by imposing the following two relations on the morphisms:

Thin associativity and coassociativity

$$(2A.8) \quad \begin{array}{c} h+1+l \\ \uparrow \\ \text{---} \text{---} \\ \uparrow \quad \uparrow \\ h \quad 1 \quad l \end{array} = \begin{array}{c} h+1+l \\ \uparrow \\ \text{---} \text{---} \\ \uparrow \quad \uparrow \\ h \quad 1 \quad l \end{array} \quad \text{and} \quad \begin{array}{c} h \quad 1 \quad l \\ \uparrow \quad \uparrow \\ \text{---} \text{---} \\ \uparrow \\ h+1+l \end{array} = \begin{array}{c} h \quad 1 \quad l \\ \uparrow \quad \uparrow \\ \text{---} \text{---} \\ \uparrow \\ h+1+l \end{array} .$$

The thin square switch

$$(2A.9) \quad \begin{array}{c} k \quad l \\ \uparrow \quad \uparrow \\ \text{---} \xrightarrow{1} \text{---} \\ \uparrow \quad \uparrow \\ k-1 \quad l+1 \\ \uparrow \quad \uparrow \\ k \quad l \end{array} = \begin{array}{c} k \quad l \\ \uparrow \quad \uparrow \\ \text{---} \xrightarrow{1} \text{---} \\ \uparrow \quad \uparrow \\ k+1 \quad l-1 \\ \uparrow \quad \uparrow \\ k \quad l \end{array} + [k-l] \begin{array}{c} k \\ \uparrow \\ \text{---} \\ \uparrow \\ k \end{array} \quad \begin{array}{c} l \\ \uparrow \\ \text{---} \\ \uparrow \\ l \end{array} ,$$

where in both defining relations we used the thick merges, splits and ladders from above.

Definition 2A.10. The two types of compositions of merges and splits

$$\begin{array}{c} k \quad l \\ \uparrow \quad \uparrow \\ \text{---} \text{---} \\ \uparrow \\ k+l \\ \uparrow \quad \uparrow \\ k \quad l \end{array} \quad \text{and} \quad \begin{array}{c} k+l \\ \uparrow \\ \text{---} \text{---} \\ \uparrow \\ k+l \\ \uparrow \quad \uparrow \\ k \quad l \end{array}$$

are called the (k, l) -dumbbell (or *dumbbell of thickness $k + l$*) and the (k, l) -digon, respectively.

Note that we also illustrate webs with potential zero or negative edges. In these cases, by convention, if a diagram has a 0-labelled edge then we remove that edge and if a diagram has a negative-labelled edge then the entire diagram is 0, e.g. the so-called *thin digon removal*

$$\begin{array}{c} k \\ \uparrow \\ \text{---} \text{---} \\ \uparrow \\ k-1 \quad 1 \\ \uparrow \\ k \end{array} = [k] \begin{array}{c} k \\ \uparrow \\ \text{---} \\ \uparrow \\ k \end{array}$$

$$\begin{aligned}
&= \frac{1}{[k]!} \begin{array}{c} h+k+l \\ \diagup \quad \diagdown \\ h \quad k \quad l \\ \text{1} \quad \dots \quad \text{1} \end{array} = \frac{1}{[k]!} \begin{array}{c} h+k+l \\ \diagup \quad \diagdown \\ h \quad k \quad l \\ \text{1} \quad \dots \quad \text{1} \end{array} = \begin{array}{c} h+k+l \\ \diagup \quad \diagdown \\ h \quad k \quad l \\ \text{1} \quad \dots \quad \text{1} \end{array}
\end{aligned}$$

where in the second, third and fourth equality we used relation [Equation 2A.8](#) to pull thin edges along thick ones from one side to the other. Thick coassociativity is proved similarly. \square

Lemma 2A.13. *The thick square switches*

$$\begin{aligned}
&\begin{array}{c} k-h+g \quad l+h-g \\ \diagup \quad \diagdown \\ k-h \quad l+h \\ \text{g} \quad \text{h} \\ \diagdown \quad \diagup \\ k \quad l \end{array} = \sum_i \begin{bmatrix} k-l+g-h \\ i \end{bmatrix} \begin{array}{c} k-h+g \quad l-g+h \\ \diagup \quad \diagdown \\ k+g-i \quad l-g+i \\ \text{h-i} \quad \text{g-i} \\ \diagdown \quad \diagup \\ k \quad l \end{array}, \\
&\begin{array}{c} k+h-g \quad l-h+g \\ \diagup \quad \diagdown \\ k+h \quad l-h \\ \text{g} \quad \text{h} \\ \diagdown \quad \diagup \\ k \quad l \end{array} = \sum_i \begin{bmatrix} l-k+g-h \\ i \end{bmatrix} \begin{array}{c} k+h-g \quad l-h+g \\ \diagup \quad \diagdown \\ k-g+i \quad l+g-i \\ \text{h-i} \quad \text{g-i} \\ \diagdown \quad \diagup \\ k \quad l \end{array},
\end{aligned}$$

and divided powers collapsing

$$\begin{aligned}
&\begin{array}{c} k+h+g \quad l-g-h \\ \diagup \quad \diagdown \\ k+h \quad l-h \\ \text{g} \quad \text{h} \\ \diagdown \quad \diagup \\ k \quad l \end{array} = \begin{bmatrix} h+g \\ g \end{bmatrix} \begin{array}{c} k+h+g \quad l-g-h \\ \diagup \quad \diagdown \\ k \quad l \\ \text{h+g} \end{array}, \\
&\begin{array}{c} k-h-g \quad l+h+g \\ \diagup \quad \diagdown \\ k-h \quad l+h \\ \text{g} \quad \text{h} \\ \diagdown \quad \diagup \\ k \quad l \end{array} = \begin{bmatrix} h+g \\ g \end{bmatrix} \begin{array}{c} k-h-g \quad l+g+h \\ \diagup \quad \diagdown \\ k \quad l \\ \text{h+g} \end{array},
\end{aligned}$$

hold in $\mathbf{SWeb}_\uparrow(\mathfrak{gl}_n)$.

Proof. This is [[ST19](#), Remark 2.5] and can be shown by using the definition of $\mathbf{SWeb}_\uparrow(\mathfrak{gl}_n)$ and [Lemma 2A.12](#). \square

As a special case of the lemma above, also the *thick digon removal* holds, i.e.

$$\begin{array}{c} k+l \\ \diagup \quad \diagdown \\ k \quad l \\ \diagdown \quad \diagup \\ k+l \end{array} = \begin{bmatrix} k+l \\ l \end{bmatrix} \begin{array}{c} k+l \\ \diagup \quad \diagdown \\ k+l \end{array}.$$

Corollary 2A.14. *Symmetric webs satisfy the so-called Serre relation*

Proof. The argument is as in [CKM14, Lemma 2.2.1] and follows from applying associativity and the thick square switches to the middle web. Note that the divided powers from the leftmost and rightmost webs collapse, using the previous lemma. \square

Remark 2A.15. The so-called higher order Serre relations as in e.g. [Lus10, Chapter 7] hold in symmetric webs as well.

Further, we want to emphasize that our thin crossings from Definition 2A.2 satisfy the braiding relations.

Lemma 2A.16. *The (thin) Reidemeister 2 and Reidemeister 3 moves hold in $\mathbf{SWeb}_\uparrow(\mathfrak{gl}_n)$, i.e.*

Proof. This can be verified via a straightforward calculation. \square

We will see later that also the thick version of the previous lemma holds, meaning that $\mathbf{SWeb}_\uparrow(\mathfrak{gl}_n)$ is a braided monoidal category. For now, note that as a direct consequence of the Lemma 2A.16 we have.

Corollary 2A.17. *Thin over and under-crossings are inverses of each other.* \square

Since in $U_q(\mathfrak{gl}_n)\text{-fdMod}$ every object has a dual and we have evaluation and coevaluation maps, we want incorporate the analogous notions into our diagrammatic category. Therefore, we define the following.

Definition 2A.18. The free thin symmetric (upward-downward pointing) category of \mathfrak{gl}_n -webs, denote it by $\mathbf{fSWeb}_{\uparrow,\downarrow}(\mathfrak{gl}_n)$, is the $\mathbb{k}(q^{\frac{1}{n}})$ -linear category monoidally generated by

- objects $\{k_\uparrow, k_\downarrow \mid k \in \mathbb{Z}_{\geq 0}\}$ with $0_\uparrow = 0_\downarrow = 0$,
- morphisms

As before, we want to consider a quotient of $\mathbf{fSWeb}_{\uparrow,\downarrow}(\mathfrak{gl}_n)$ by some relations on the morphisms and in order to give these relations we need to define some other webs. First, we define upward pointing thin crossings as in Definition 2A.2, thick upward crossings as in Definition 2A.3, the $(1, k)$ -merges and splits as in Definition 2A.4 and also the thick merges and splits as in Definition 2A.5. Then we continue as follows.

Definition 2A.19. We define the following:

Leftward (thin) crossings

$$\begin{array}{c} \begin{array}{c} 1 & 1 \\ \swarrow & \searrow \\ 1 & 1 \end{array} := \begin{array}{c} \begin{array}{c} 1 & 1 \\ \downarrow & \downarrow \end{array} \\ \downarrow & \downarrow \end{array} \quad \text{and} \quad \begin{array}{c} \begin{array}{c} 1 & 1 \\ \swarrow & \searrow \\ 1 & 1 \end{array} := \begin{array}{c} \begin{array}{c} 1 & 1 \\ \downarrow & \downarrow \end{array} \\ \downarrow & \downarrow \end{array} ; \end{array}$$

downward pointing (thin) over and under-crossings

$$\begin{array}{c} \begin{array}{c} 1 & 1 \\ \swarrow & \searrow \\ 1 & 1 \end{array} := \begin{array}{c} \begin{array}{c} 1 & 1 \\ \downarrow & \downarrow \end{array} \\ \downarrow & \downarrow \end{array} , \quad \begin{array}{c} \begin{array}{c} 1 & 1 \\ \swarrow & \searrow \\ 1 & 1 \end{array} := \begin{array}{c} \begin{array}{c} 1 & 1 \\ \downarrow & \downarrow \end{array} \\ \downarrow & \downarrow \end{array} . \end{array}$$

Definition 2A.20. The k -labelled caps are defined via explosion

$$\begin{array}{c} \begin{array}{c} \curvearrowright \\ k \quad k \end{array} = \frac{1}{[k]!} \begin{array}{c} \begin{array}{c} 1 \\ \vdots \\ 1 \end{array} \\ \downarrow & \downarrow \\ k & k \end{array} \end{array}$$

and similarly the k -labelled cups.

We will later impose that the (thin) leftward crossings are invertible and we will draw their inverses as (thin) *rightward crossings*, i.e.

$$\left(\begin{array}{c} \begin{array}{c} 1 & 1 \\ \swarrow & \searrow \\ 1 & 1 \end{array} \right)^{-1} := \begin{array}{c} \begin{array}{c} 1 & 1 \\ \swarrow & \searrow \\ 1 & 1 \end{array} \quad \text{and} \quad \left(\begin{array}{c} \begin{array}{c} 1 & 1 \\ \swarrow & \searrow \\ 1 & 1 \end{array} \right)^{-1} := \begin{array}{c} \begin{array}{c} 1 & 1 \\ \swarrow & \searrow \\ 1 & 1 \end{array} . \end{array}$$

Definition 2A.21. The *thick leftward* crossings are defined by explosion

$$\begin{array}{c} \begin{array}{c} l & k \\ \swarrow & \searrow \\ k & l \end{array} = \frac{1}{[k]!} \frac{1}{[l]!} \begin{array}{c} \begin{array}{c} l & k \\ \swarrow & \searrow \\ k & l \end{array} \end{array} .$$

and similarly the *thick rightward* crossings.

Definition 2A.22. The *rightward cap and cup* are defined as

$$\begin{array}{c} \begin{array}{c} \curvearrowright \\ 1 & 1 \end{array} := q^{n-\frac{1}{n}} \begin{array}{c} \begin{array}{c} 1 & 1 \\ \swarrow & \searrow \\ 1 & 1 \end{array} \end{array} , \quad \begin{array}{c} \begin{array}{c} 1 & 1 \\ \swarrow & \searrow \\ 1 & 1 \end{array} := q^{\frac{1}{n}-n} \begin{array}{c} \begin{array}{c} 1 & 1 \\ \swarrow & \searrow \\ 1 & 1 \end{array} \end{array} , \end{array}$$

and their thick versions are obtained by explosion.

Definition 2A.23. The *thin symmetric (upward-downward pointing) category* of \mathfrak{gl}_n -webs, denote it by $\mathbf{SWeb}_{\uparrow,\downarrow}(\mathfrak{gl}_n)$, is the quotient category obtained from $\mathbf{fSWeb}_{\uparrow,\downarrow}(\mathfrak{gl}_n)$ by imposing relations Equation 2A.8 and Equation 2A.9 together with their downward pointing versions, and relations Equation 2A.24-Equation 2A.27 from below.

Invertibility of thin leftward crossings

$$(2A.24) \quad \begin{array}{c} 1 \\ \swarrow \downarrow \\ 1 \end{array} \quad \text{and} \quad \begin{array}{c} 1 \\ \swarrow \uparrow \\ 1 \end{array} .$$

The thin zigzag relation

$$(2A.25) \quad \begin{array}{c} 1 \\ \downarrow \uparrow \\ 1 \end{array} = \begin{array}{c} 1 \\ \downarrow \\ 1 \end{array}, \quad \begin{array}{c} 1 \\ \uparrow \downarrow \\ 1 \end{array} = \begin{array}{c} 1 \\ \uparrow \\ 1 \end{array} .$$

The merge-split slides

$$(2A.26) \quad \begin{array}{c} \text{merge} \\ \downarrow \\ k+1 \quad 1 \quad k \end{array} = \begin{array}{c} \text{split} \\ \downarrow \\ k+1 \quad 1 \quad k \end{array}, \quad \begin{array}{c} \text{merge} \\ \downarrow \\ k \quad 1 \quad k+1 \end{array} = \begin{array}{c} \text{split} \\ \downarrow \\ k \quad 1 \quad k+1 \end{array}, \quad k \geq 1$$

together with their cup and opposite orientation versions.

The 1-labelled circle removal

$$(2A.27) \quad \bigcirc_1 = [n].$$

Note that 1_\uparrow and 1_\downarrow are duals to each other by the thin zigzag relation Equation 2A.25. Later we will show that for every $k \geq 1$, k_\uparrow and k_\downarrow are duals to each other meaning that $\mathbf{SWeb}_{\uparrow,\downarrow}(\mathfrak{gl}_n)$ is endowed with a rigid structure.

Remark 2A.28. We could also define $\mathbf{SWeb}_{\uparrow,\downarrow}(\mathfrak{gl}_n)$ using only upward pointing merges and splits but then we would have to include caps and cups of *any* thickness as generators. In that case we would define the downward pointing merges and splits like below

$$\begin{array}{c} k+1 \\ \downarrow \\ k \quad 1 \end{array} := \begin{array}{c} k+1 \\ \downarrow \uparrow \\ k \quad 1 \end{array}, \quad \begin{array}{c} k \quad 1 \\ \downarrow \\ k+1 \end{array} := \begin{array}{c} k \quad 1 \\ \downarrow \uparrow \\ k+1 \end{array}$$

(see also Corollary 2B.4).

2B. Properties of webs. We now give the first consequences of the defining web relations.

Lemma 2B.1. Relations Equation 2A.25 and Equation 2A.26 imply the thick zigzag relations

$$\begin{array}{c} k \\ \downarrow \uparrow \\ k \end{array} = \begin{array}{c} k \\ \downarrow \\ k \end{array}, \quad \begin{array}{c} k \\ \uparrow \downarrow \\ k \end{array} = \begin{array}{c} k \\ \uparrow \\ k \end{array} .$$

Proof. Using Lemma 2A.12 we see that we can adapt the proof of [RT16, Lemma 2.21]. Namely, after explosion, using thin zigzag and merge-split slides we have

$$\begin{array}{c} k \\ \downarrow \uparrow \\ k \end{array} = \frac{1}{[k]!} \begin{array}{c} k \\ \downarrow \uparrow \\ \downarrow \\ k \end{array} \stackrel{\text{Equation 2A.26}}{=} \frac{1}{[k]!} \begin{array}{c} k \\ \downarrow \uparrow \\ \downarrow \uparrow \\ \downarrow \\ k \end{array} \stackrel{\text{Equation 2A.25}}{=} \frac{1}{[k]!} \begin{array}{c} k \\ \downarrow \uparrow \\ \downarrow \uparrow \\ \downarrow \uparrow \\ \downarrow \\ k \end{array} = \begin{array}{c} k \\ \downarrow \\ k \end{array}$$

and similarly for the other thick zigzag relation. \square

A direct consequence of this lemma is the following.

Corollary 2B.2. *The category $\mathbf{SWeb}_{\uparrow,\downarrow}(\mathfrak{gl}_n)$ can be endowed with a pivotal structure, where k_{\uparrow} and k_{\downarrow} are dual to each other. \square*

We will use this pivotal structure throughout this paper.

Lemma 2B.3. *The thick versions of relation Equation 2A.26 hold, i.e.*

$$\begin{array}{c} \text{Diagram 1} \\ \text{Diagram 2} \end{array} = \begin{array}{c} \text{Diagram 3} \\ \text{Diagram 4} \end{array}, \quad \begin{array}{c} \text{Diagram 5} \\ \text{Diagram 6} \end{array} = \begin{array}{c} \text{Diagram 7} \\ \text{Diagram 8} \end{array}, \quad k, l \geq 1$$

as well as their cup and opposite orientation versions.

Proof. We prove the first relation via induction on $k + l$. The case $k + l = 1$ follows trivially. Assume it holds for thickness smaller or equal to $k + l - 1$. We have

$$\begin{array}{c} \text{Diagram 1} \\ \text{Diagram 2} \end{array} = \frac{1}{[l]} \begin{array}{c} \text{Diagram 3} \\ \text{Diagram 4} \end{array} \stackrel{\text{Equation 2A.26, Equation 2A.8}}{=} \frac{1}{[l]} \begin{array}{c} \text{Diagram 5} \\ \text{Diagram 6} \end{array} \stackrel{k+l-1}{=} \begin{array}{c} \text{Diagram 7} \\ \text{Diagram 8} \end{array} \\ \stackrel{k+l-1}{=} \frac{1}{[l]} \begin{array}{c} \text{Diagram 9} \\ \text{Diagram 10} \end{array} = \begin{array}{c} \text{Diagram 11} \\ \text{Diagram 12} \end{array},$$

where in the third equality we used the induction hypothesis to slide the $(k, l - 1)$ split and in the last equality we used relation Equation 2A.26 for the $(k + l - 1, 1)$ split, then associativity and the digon removal. \square

Corollary 2B.4. *We have the following*

$$\begin{array}{c} \text{Diagram 1} \\ \text{Diagram 2} \end{array} = \begin{array}{c} \text{Diagram 3} \\ \text{Diagram 4} \end{array}, \quad \begin{array}{c} \text{Diagram 5} \\ \text{Diagram 6} \end{array} = \begin{array}{c} \text{Diagram 7} \\ \text{Diagram 8} \end{array}.$$

Proof. This is a direct consequence of the previous lemma and thick zigzag relation. \square

The next lemma shows that in $\mathbf{SWeb}_{\uparrow,\downarrow}(\mathfrak{gl}_n)$ we have a relation akin to the usual planar isotopies, namely a relation of Reidemeister 1 type.

Lemma 2B.5. *The following holds*

$$\begin{array}{c} \text{Diagram 1} \\ \text{Diagram 2} \end{array} = q^{n-\frac{1}{n}} \begin{array}{c} \text{Diagram 3} \\ \text{Diagram 4} \end{array} = \begin{array}{c} \text{Diagram 5} \\ \text{Diagram 6} \end{array}$$

as well as its downward pointing version and

$$\begin{array}{c} \text{Diagram 1} \\ \text{Diagram 2} \end{array} = q^{\frac{1}{n}-n} \begin{array}{c} \text{Diagram 3} \\ \text{Diagram 4} \end{array} = \begin{array}{c} \text{Diagram 5} \\ \text{Diagram 6} \end{array}$$

as well as its downward pointing version.

Proof. From the definition of the rightward cap

$$q^{n-\frac{1}{n}} \begin{array}{c} \curvearrowright \\ \diagdown \diagup \\ 1 \quad 1 \end{array} = \begin{array}{c} \curvearrowright \\ 1 \quad 1 \end{array}$$

after adding a crossing and using the fact that the right over-crossing is the inverse of the left under-crossing we obtain

$$q^{n-\frac{1}{n}} \begin{array}{c} \curvearrowright \\ \diagdown \diagup \\ \diagdown \diagup \\ 1 \quad 1 \end{array} = \begin{array}{c} \curvearrowright \\ \diagdown \diagup \\ 1 \quad 1 \end{array},$$

$$q^{n-\frac{1}{n}} \begin{array}{c} \curvearrowright \\ 1 \quad 1 \end{array} = \begin{array}{c} \curvearrowright \\ \diagdown \diagup \\ 1 \quad 1 \end{array}.$$

Further, by adding caps on both sides we have

$$q^{n-\frac{1}{n}} \begin{array}{c} \uparrow \\ \curvearrowright \\ \downarrow \\ 1 \end{array} = \begin{array}{c} \uparrow \\ \curvearrowright \\ \diagdown \diagup \\ \downarrow \\ 1 \end{array}$$

and thus by straightening the left-hand side

$$q^{n-\frac{1}{n}} \begin{array}{c} \uparrow \\ | \\ \downarrow \\ 1 \end{array} = \begin{array}{c} \uparrow \\ \curvearrowright \\ \diagdown \diagup \\ \downarrow \\ 1 \end{array}.$$

However,

$$\begin{array}{c} \uparrow \\ \curvearrowright \\ \diagdown \diagup \\ \downarrow \\ 1 \end{array} = \begin{array}{c} \uparrow \\ | \\ \diagdown \diagup \\ | \\ \downarrow \\ 1 \end{array} = \begin{array}{c} \uparrow \\ \diagdown \diagup \\ \downarrow \\ 1 \end{array}$$

where in the first equality we used the definition of the left crossing and in the second we used the zigzag relation. This means that

$$q^{n-\frac{1}{n}} \begin{array}{c} \uparrow \\ | \\ \downarrow \\ 1 \end{array} = \begin{array}{c} \uparrow \\ \diagdown \diagup \\ \downarrow \\ 1 \end{array}.$$

All other equalities can be proved verbatim. □

Corollary 2B.6. *The 1-circle evaluation with reversed orientation also holds, i.e.*

$$\begin{array}{c} \curvearrowleft \\ \circlearrowleft \\ 1 \end{array} = [n].$$

Proof. This follows from [Definition 2A.22](#), [Definition 2A.19](#), the previous lemma and relation [Equation 2A.27](#). □

Proof. From the previous two lemmas we have

$$\begin{array}{c} 1 \\ \downarrow \\ \text{wavy line} \\ \downarrow \\ 1 \end{array} = q^{\frac{1}{n}-n} \begin{array}{c} 1 \\ \downarrow \\ \text{wavy line with loop} \\ \downarrow \\ 1 \end{array} = q^{\frac{1}{n}-n} \begin{array}{c} 1 \\ \downarrow \\ \text{wavy line with loop} \\ \downarrow \\ 1 \end{array} = q^{\frac{1}{n}-n} \cdot q^{n-\frac{1}{n}} \begin{array}{c} 1 \\ \downarrow \\ \downarrow \\ 1 \end{array} = \begin{array}{c} 1 \\ \downarrow \\ \downarrow \\ 1 \end{array}.$$

Now we use this together with the digon removal and the relations [Equation 2A.25](#) to obtain the thick version

$$\begin{array}{c} k \\ \downarrow \\ \text{wavy line} \\ \downarrow \\ k \end{array} = \frac{1}{[k]!} \begin{array}{c} k \\ \downarrow \\ \text{wavy line with loop} \\ \downarrow \\ k \end{array} = \frac{1}{[k]!} \begin{array}{c} k \\ \downarrow \\ \text{wavy line with loop} \\ \downarrow \\ k \end{array} = \frac{1}{[k]!} \begin{array}{c} k \\ \downarrow \\ \text{thick line} \\ \downarrow \\ k \end{array} = \begin{array}{c} k \\ \downarrow \\ \downarrow \\ k \end{array}.$$

The other equation is proved similarly. □

Lemma 2B.11. *The so-called pitchfork relations hold*

$$\begin{array}{c} l_2 \\ \swarrow \\ l_1 \end{array} \begin{array}{c} \swarrow \\ k \\ \downarrow \\ l \end{array} = \begin{array}{c} l_2 \\ \swarrow \\ l_1 \end{array} \begin{array}{c} \swarrow \\ k \\ \downarrow \\ l \end{array}, \quad \begin{array}{c} l_2 \\ \swarrow \\ l_1 \end{array} \begin{array}{c} \swarrow \\ l \\ \downarrow \\ k \end{array} = \begin{array}{c} l_2 \\ \swarrow \\ l_1 \end{array} \begin{array}{c} \swarrow \\ l \\ \downarrow \\ k \end{array}$$

together with the merge and downwards pointing versions.

Proof. We prove the first relation via induction of $k + l$. For $k + l = 1$, this follows trivially. Assume the relation holds for labels whose sum is smaller than $k + l$. We explode the k -edge as below

$$\begin{array}{c} l_2 \\ \swarrow \\ l_1 \end{array} \begin{array}{c} \swarrow \\ k \\ \downarrow \\ l \end{array} = \frac{1}{[k]} \begin{array}{c} l_2 \\ \swarrow \\ l_1 \end{array} \begin{array}{c} \swarrow \\ 1 \\ \downarrow \\ k-1 \\ \downarrow \\ l \end{array}.$$

Now, using the induction hypothesis, we slide the edges labelled by 1 and $k - 1$ through the (l_1, l_2) -split and after removing the digon we obtain

$$\begin{array}{c} l_2 \\ \swarrow \\ l_1 \end{array} \begin{array}{c} \swarrow \\ k \\ \downarrow \\ l \end{array}$$

The second relation is shown verbatim. □

Corollary 2B.12. *Combining the result above for merges and splits, we have that also the sliding of edges through dumbbells hold.* □

Corollary 2B.13. *The thick versions of Reidemeister 2 and 3 from [Lemma 2A.16](#) hold. Namely,*

$$\begin{array}{c} k \quad l \\ \swarrow \quad \swarrow \\ \downarrow \quad \downarrow \\ k \quad l \end{array} = \begin{array}{c} k \quad l \\ \downarrow \quad \downarrow \\ k \quad l \end{array} = \begin{array}{c} k \quad l \\ \swarrow \quad \swarrow \\ \downarrow \quad \downarrow \\ k \quad l \end{array} \quad \text{and}$$

$$\begin{array}{c} m \quad l \quad k \\ \swarrow \quad \swarrow \quad \swarrow \\ \downarrow \quad \downarrow \quad \downarrow \\ k \quad l \quad m \end{array} = \begin{array}{c} m \quad l \quad k \\ \swarrow \quad \swarrow \quad \swarrow \\ \downarrow \quad \downarrow \quad \downarrow \\ k \quad l \quad m \end{array}.$$

Proof. We prove only the first equality in Reidemeister 2. From [Definition 2A.3](#), [Corollary 2B.12](#), [Lemma 2A.16](#) and the digon removal we have

$$\begin{array}{c} \begin{array}{c} \nearrow^k \\ \searrow^l \\ \nearrow^k \\ \searrow^l \end{array} \end{array} = \frac{1}{([k]!)^2} \frac{1}{([l]!)^2} \begin{array}{c} \begin{array}{c} \nearrow^k \\ \searrow^l \\ \nearrow^k \\ \searrow^l \end{array} \\ \text{---} \\ \begin{array}{c} \searrow^k \\ \nearrow^l \\ \searrow^k \\ \nearrow^l \end{array} \end{array} = \frac{1}{[k]!} \frac{1}{[l]!} \begin{array}{c} \begin{array}{c} \nearrow^k \\ \searrow^l \\ \nearrow^k \\ \searrow^l \end{array} \\ \text{---} \\ \begin{array}{c} \searrow^k \\ \nearrow^l \\ \searrow^k \\ \nearrow^l \end{array} \end{array} = \begin{array}{c} \begin{array}{c} \nearrow^k \\ \searrow^l \\ \nearrow^k \\ \searrow^l \end{array} \\ \text{---} \\ \begin{array}{c} \searrow^k \\ \nearrow^l \\ \searrow^k \\ \nearrow^l \end{array} \end{array}$$

where in the second equation we used [Corollary 2B.12](#) to move the central dumbbells up and then we used the fact that thin over and under-crossings are inverses to each other. \square

Note that from the previous lemma follows that $\mathbf{SWeb}_{\uparrow, \downarrow}(\mathfrak{gl}_n)$ is a braided category. In particular we have that the (l, k) over-crossing and the (k, l) under-crossing are inverses to each other. Another direct consequence is the following.

Corollary 2B.14. *The leftward and rightward thick crossings are inverse to each other.* \square

Proposition 2B.15. *For any two objects \vec{k} and \vec{l} of $\mathbf{SWeb}_{\uparrow, \downarrow}(\mathfrak{gl}_n)$ there exist objects \vec{k}' and \vec{l}' (defined in the proof) of $\mathbf{SWeb}_{\uparrow}(\mathfrak{gl}_n)$ such that there is an isomorphism of $\mathbb{k}(q^{\frac{1}{n}})$ -vector spaces*

$$\text{Hom}_{\mathbf{SWeb}_{\uparrow, \downarrow}(\mathfrak{gl}_n)}(\vec{k}, \vec{l}) \cong \text{Hom}_{\mathbf{SWeb}_{\uparrow}(\mathfrak{gl}_n)}(\vec{k}', \vec{l}').$$

Proof. Let w be a web in $\text{Hom}_{\mathbf{SWeb}_{\uparrow, \downarrow}(\mathfrak{gl}_n)}(\vec{k}, \vec{l})$. Invertibility of crossings ([Corollary 2B.13](#) and [Corollary 2B.14](#)) and the invertibility of zigzag relations [Equation 2A.25](#) imply that the usual isomorphism in braided pivotal categories holds. In pictures, this isomorphism looks e.g.

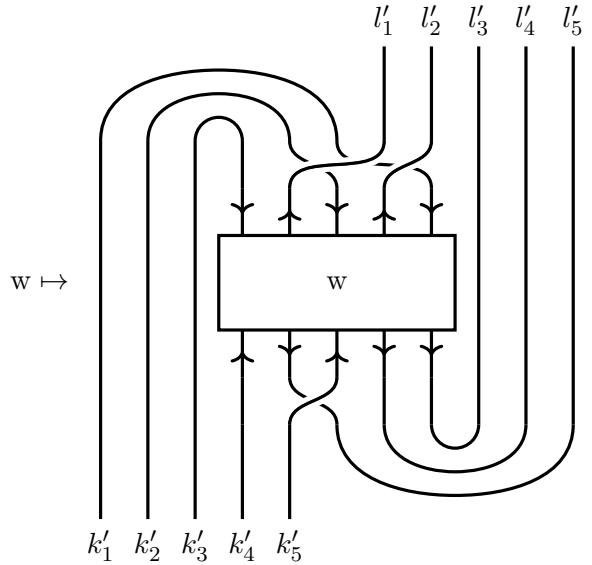

which is evidently an invertible operation. \square

Remark 2B.16. Note that [Proposition 2B.15](#) only uses invertibility of crossings and the zigzag relations. In particular, it also holds for other web categories with duals and invertible crossings which are going to be discussed in this paper, not just $\mathbf{SWeb}_{\uparrow, \downarrow}(\mathfrak{gl}_n)$.

The splits and merges, when composed with the corresponding crossings, are “mirrored” as we will explain in the following lemma.

Lemma 2B.17. *We have*

$$\begin{array}{c} \begin{array}{c} \nearrow^l \\ \searrow^k \\ \nearrow^k \\ \searrow^l \\ \nearrow^{k+l} \end{array} \end{array} = q^{-\frac{kl}{n} + kl} \begin{array}{c} \begin{array}{c} \nearrow^k \\ \searrow^l \\ \nearrow^l \\ \searrow^k \\ \nearrow^{k+l} \end{array} \end{array}$$

$$\begin{array}{c} l \\ \diagdown \\ \text{---} \\ \diagup \\ k \\ \text{---} \\ \text{---} \\ \text{---} \\ \text{---} \\ k+l \end{array} = q^{\frac{kl}{n} + kl} \begin{array}{c} k \quad l \\ \diagdown \quad \diagup \\ \text{---} \\ \text{---} \\ \text{---} \\ k+l \end{array}$$

and merges have the same behaviour.

Proof. We prove this via the exploded crossing formula in Definition 2A.3. First, the case $k = l = 1$ can be verified via a direct computation using Definition 2A.2. The relevant diagrammatic calculation is now

$$\begin{array}{c} k \quad l \\ \diagdown \quad \diagup \\ \text{---} \\ \text{---} \\ \text{---} \\ \text{---} \\ k+l \end{array} = \frac{1}{[k]![l]!} \begin{array}{c} k \quad l \\ \diagdown \quad \diagup \\ \text{---} \\ \text{---} \\ \text{---} \\ \text{---} \\ k+l \end{array} = \frac{q^{-\frac{kl}{n} + kl}}{[k]![l]!} \begin{array}{c} k \quad l \\ \diagdown \quad \diagup \\ \text{---} \\ \text{---} \\ \text{---} \\ \text{---} \\ k+l \end{array} \\
 = q^{-\frac{kl}{n} + kl} \begin{array}{c} k \quad l \\ \diagdown \quad \diagup \\ \text{---} \\ \text{---} \\ \text{---} \\ k+l \end{array} .
 \end{array}$$

Let us explain the second equality. Successively, using associativity in the bottom bouquet we can always match a crossing with a corresponding split, giving a factor $q^{-\frac{1}{n} + 1}$. As there are kl crossings to be absorbed, then the overall factor is $q^{-\frac{kl}{n} + kl}$. All other cases follow mutatis mutandis. \square

Further, we have the next two lemmas.

Lemma 2B.18. *The following relation of Reidemeister 1 type*

$$\begin{array}{c} k \\ \diagup \\ \text{---} \\ \diagdown \\ k \end{array} = q^{k(k - \frac{k}{n} + n - 1)} \begin{array}{c} k \\ \uparrow \\ \text{---} \\ k \end{array} = \begin{array}{c} k \\ \uparrow \\ \text{---} \\ \diagdown \\ k \end{array}$$

as well as its downward pointing version and

$$\begin{array}{c} k \\ \diagdown \\ \text{---} \\ \diagup \\ k \end{array} = q^{-k(k - \frac{k}{n} + n - 1)} \begin{array}{c} k \\ \uparrow \\ \text{---} \\ k \end{array} = \begin{array}{c} k \\ \uparrow \\ \text{---} \\ \diagup \\ k \end{array}$$

as well as its downward pointing version hold.

Proof. Using explosion, the previous lemma and the various established topological properties, the main thing to observe is that a Reidemeister 1 picture with k parallel thin strands can be

topologically rewritten as follows

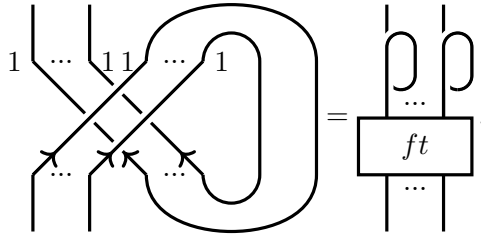

Here ft is the full twist on k strands which has $k(k-1)$ crossings. Now we first need to absorb the full twist using the previous lemma giving a factor $q^{-\frac{k(k-1)}{n} + k(k-1)}$. Then we use the thin Reidemeister 1 move from [Lemma 2B.5](#) to get the factor $q^{k(n-\frac{1}{n})}$. Thus, the overall factor is $q^{k(k-\frac{k}{n}+n-1)}$. All other cases follow mutatis mutandis. \square

Lemma 2B.19. *The sliding of thick edges through thick caps holds, together with its cup, reversed orientation and over-crossing versions*

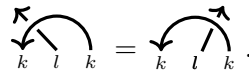

Proof. The case $k = l = 1$ follows from a direct check using the definition of the leftward crossings. The general case is:

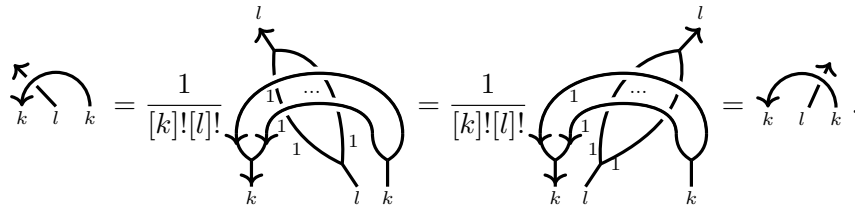

Here we exploded the strings. \square

Definition 2B.20. Let $k \in \mathbb{Z}_{>0}$. The k -th symmetric \mathfrak{gl}_n -projector e_k is defined via

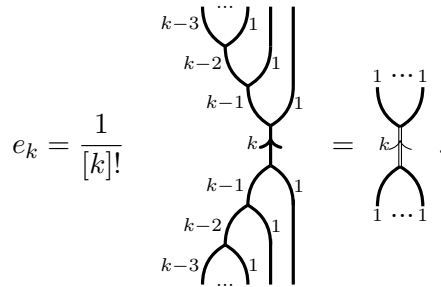

The reader familiar with the Jones–Wenzl recursion will recognize the following lemma. However, as a word of warning, the scalars are not the same as in the classical Jones–Wenzl recursion.

Lemma 2B.21. *We have:*

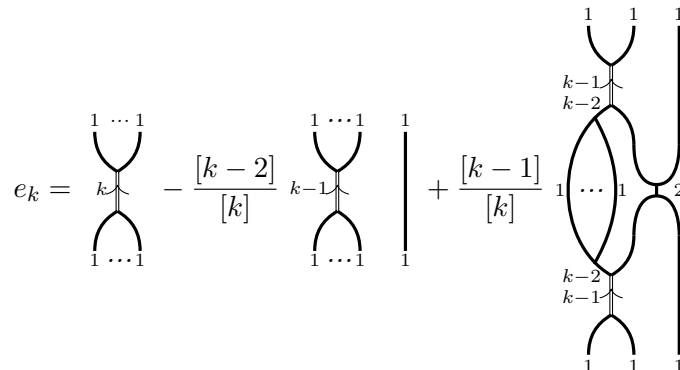

for all $k \in \mathbb{Z}_{\geq 3}$.

Proof. The proof is similar to that of [RT16, Lemma 2.13]. \square

2C. A basis for thin webs. Recall the exterior \mathfrak{sl}_n -webs from [CKM14]. We point out here that for $U_q(\mathfrak{gl}_n)$ we have $\bigwedge_q^n(\mathbb{k}_q^n) \not\cong \mathbb{k}_q$, whereas for $U_q(\mathfrak{sl}_n)$ we have $\bigwedge_q^n(\mathbb{k}_q^n) \cong \mathbb{k}_q$. ($\bigwedge_q^n(\mathbb{k}_q^n)$ is the quantum analog of the determinant representation of the general linear group.) So, for exterior \mathfrak{sl}_n -webs the n -labelled edges are 0-labelled and thus are removed from the illustrations.

In [Eli15], Elias constructed a basis for exterior \mathfrak{sl}_n -webs whose elements are called double light ladders. We will be considering only the basis of $\text{End}_{\mathbf{EWeb}_{\uparrow,\downarrow}(\mathfrak{sl}_n)}(1_{\uparrow}^{\otimes k})$, $k \geq 1$. (The notation means exterior webs, see above.) We modify the later by performing an algorithm leading to a basis of $\text{End}_{\mathbf{SWeb}_{\uparrow}(\mathfrak{gl}_n)}(1_{\uparrow}^{\otimes k})$. We colour the thick edges of symmetric webs by red and those of exterior webs by green. These webs are related by the following relation

$$\begin{array}{c} 1 \quad 1 \\ \diagdown \quad \diagup \\ \color{red}{\text{---}} \color{red}{2} \\ \diagup \quad \diagdown \\ 1 \quad 1 \end{array} = - \begin{array}{c} 1 \quad 1 \\ \diagdown \quad \diagup \\ \color{green}{\text{---}} \color{green}{2} \\ \diagup \quad \diagdown \\ 1 \quad 1 \end{array} + [2] \begin{array}{c} 1 \quad 1 \\ | \quad | \\ 1 \quad 1 \end{array}.$$

The three definitions from below will be used for both exterior and symmetric webs.

Definition 2C.1. A web with 1-labelled boundary edges is called a *local dumbbell* if it contains only dumbbells and identity components.

Lemma 2C.2. Let X be a local dumbbell. Then X can be written as a linear combination of webs containing only 2-dumbbells (dumbbells whose thickest label is 2) and identity components.

Proof. This follows from the \mathfrak{gl}_n -projector recursion in Lemma 2B.21. \square

Definition 2C.3. We call the linear combination from above *the thin expression* of the local dumbbell X .

Definition 2C.4. We say that a local dumbbell X is *smaller or equal* to the local dumbbell Y , we write $X \leq Y$, if the total number of the 2-dumbbells appearing in the thin expression of X is smaller or equal to the total number of the 2-dumbbells appearing in the thin expression of Y .

Now, let B_1, \dots, B_l be the basis elements of $\text{End}_{\mathbf{EWeb}_{\uparrow,\downarrow}(\mathfrak{sl}_n)}(1_{\uparrow}^{\otimes k})$ from [Eli15]. We perform the following two steps:

Step 1. In each of the webs B_1, \dots, B_l we change every cup and cap of the form

$$\begin{array}{c} n-k \quad k \\ \cup \end{array}, \quad \begin{array}{c} \cap \\ n-k \quad k \end{array}$$

to splits and merges of the form

$$\begin{array}{c} n-k \quad k \\ \diagdown \quad \diagup \\ n \end{array}, \quad \begin{array}{c} n \\ \diagup \quad \diagdown \\ n-k \quad k \end{array},$$

where the n -labelled edge has no self-intersections. Similarly we define the operation for the mirrored webs. In order for this operation to be well-defined we take the construction of webs as morphisms in a monoidal category given by generators–relations. Now, whenever this would lead to crossings of webs, we pull the n -labelled edges under and outside to the right like below

$$\begin{array}{c} \diagup \quad \diagdown \\ \color{green}{\text{---}} \color{green}{n} \\ \diagdown \quad \diagup \\ n-k \quad k \end{array} \mapsto \begin{array}{c} n \\ \diagup \quad \diagdown \\ \color{green}{\text{---}} \color{green}{n} \\ \diagdown \quad \diagup \\ n-k \quad k \end{array}.$$

Note that here we are making a choice. The reader might wonder why this is well-defined and what happens if for example we let

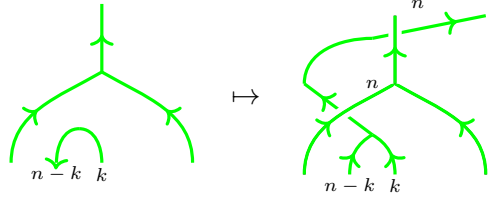

We point out that all such choices would lead to the same web due to the ambient isotopies such as zigzag relations, Reidemeister 2 and 3 moves, pitchfork relations, cup and cap slides etc. Moreover, if there are multiple caps, then we choose an arbitrary order of their end points noting that

$$\begin{array}{c} n \quad n \\ \swarrow \quad \searrow \\ n \quad n \end{array} = \begin{array}{c} n \quad n \\ \uparrow \quad \uparrow \\ n \quad n \end{array} = \begin{array}{c} n \quad n \\ \swarrow \quad \searrow \\ n \quad n \end{array},$$

modulo lower terms. (see [Lat21])

Step 2. We change the colours from green to red.

Lemma 2C.5. *If we apply Step 1 from above to the double ladder basis, we obtain a basis for $\text{End}_{\mathbf{EWeb}_\uparrow(\mathfrak{gl}_n)}(1^{\otimes k})$.*

Proof. Let B'_1, \dots, B'_l be the \mathfrak{gl}_n -webs obtained from the \mathfrak{sl}_n -webs B_1, \dots, B_l (double ladders) after Step 1. Note that the reason why we are performing Step 1 is because for \mathfrak{sl}_n -webs we do not have edges of labels $\geq n$ and exterior \mathfrak{sl}_n -webs are a quotient of exterior \mathfrak{gl}_n -webs by

$$\downarrow k = \uparrow n - k.$$

Now, the webs B'_1, \dots, B'_l are linearly independent. Indeed, if they were linearly dependent, after passing to \mathfrak{sl}_n -webs (by imposing the relation above) we would get that B_1, \dots, B_l are linearly dependent, contradicting the fact that they form a basis. It remains to show that B'_1, \dots, B'_l span $\text{End}_{\mathbf{EWeb}_\uparrow(\mathfrak{gl}_n)}(1^{\otimes k})$. This is a word for word adaption of the proof of [Eli15, Theorem 2.39]. Indeed, Elias points out that his proof would apply to any class of morphism satisfying [Eli15, Proposition 2.42]. This finishes the proof. (see [Lat21] for more details). \square

Proposition 2C.6. *If we apply Step 1 and Step 2 to the the double ladder basis we obtain a basis $\{\tilde{B}_1, \dots, \tilde{B}_l\}$ for $\text{End}_{\mathbf{SWeb}_\uparrow(\mathfrak{gl}_n)}(1^{\otimes k})$.*

Proof. Let $\{B'_1, \dots, B'_l\}$ be the basis for $\text{End}_{\mathbf{EWeb}_\uparrow(\mathfrak{gl}_n)}(1^{\otimes k})$ from the lemma above. We use the following strategy:

- (a) First, we replace each B'_i by a linear combination of webs containing only 2-dumbbells and identities locally.
- (b) Second, we change the colours of the resulting webs.
- (c) In these steps it is crucial that we have an order on webs given by counting 2-dumbbells, so both of the above will produce a triangular change-of-basis matrix.

We now give the details. By construction, each of the webs B'_i is locally built from dumbbells and identities. Now we use the exterior version of \mathfrak{gl}_n -projector recursion from Lemma 2B.21 to write every B'_i as a linear combination of webs built from only 2-dumbbells and identities. Without loss of generality we assume that $B'_1 \leq \dots \leq B'_l$. Note that there is a biggest web in the \mathfrak{gl}_n -projector formula (Lemma 2B.21), namely the rightmost web. After performing all possible recursive steps, we will have one web which is the overall biggest in the thin expression of each k -dumbbell and consequently of each B'_i . Let W_i be the biggest web appearing in the thin expression of B'_i . From the discussion above, the coefficient of W_i in the thin expression of B'_i is invertible. Inductively one concludes that the change-of-basis matrix from B'_i to W_i is triangular with invertible diagonal entries. This means that W_1, \dots, W_l are linearly independent and consequently they form a basis for $\text{End}_{\mathbf{EWeb}_\uparrow(\mathfrak{gl}_n)}(1^{\otimes k})$. Also, note that $W_1 \leq \dots \leq W_l$.

After applying Step 2, i.e. changing the colours of the webs W_1, \dots, W_l , we denote the new webs by $\tilde{W}_1, \dots, \tilde{W}_l$. We claim that they are linearly independent. Indeed, using the relation

$$\begin{array}{c} 1 \quad 1 \\ \diagdown \quad \diagup \\ \text{red 2-dumbbell} \\ \diagup \quad \diagdown \\ 1 \quad 1 \end{array} = - \begin{array}{c} 1 \quad 1 \\ \diagdown \quad \diagup \\ \text{green 2-dumbbell} \\ \diagup \quad \diagdown \\ 1 \quad 1 \end{array} + [2] \begin{array}{c} 1 \quad 1 \\ | \quad | \\ 1 \quad 1 \end{array}$$

we can write each symmetric web \tilde{W}_i as a linear combination of exterior webs. Recall that by definition, the number of 2-dumbbell components in a web \tilde{W}_i is the same as the number of 2-dumbbell components in W_i . So, $\tilde{W}_1 \leq \dots \leq \tilde{W}_l$. Now, from the above relation we can write each \tilde{W}_i as a linear combination of exterior basis webs W_j , such that $W_j \leq W_i$. Moreover, again from the same relation we have that the coefficient of W_i in this linear combination is $(-1)^a$, where a is the number of 2-dumbbell components of W_i . This means that the change-of-basis matrix from symmetric to exterior webs is triangular with determinant ± 1 . This concludes the proof that $\tilde{W}_1, \dots, \tilde{W}_l$ are linearly independent. Since the algorithm sends exterior web generators to symmetric web generator, then $\{\tilde{W}_1, \dots, \tilde{W}_l\}$ is a basis for $\text{End}_{\mathbf{SWeb}_\uparrow(\mathfrak{gl}_n)}(1^{\otimes k})$. Finally, note that by construction, \tilde{W}_i is the biggest web appearing in the thin expression of \tilde{B}_i . Thus, like before, the change-of-basis matrix from \tilde{W}_i to \tilde{B}_i is triangular with non-zero diagonal entries, meaning that $\{\tilde{B}_1, \dots, \tilde{B}_l\}$ is a basis for $\text{End}_{\mathbf{SWeb}_\uparrow(\mathfrak{gl}_n)}(1^{\otimes k})$. \square

2D. Exterior and red-green webs. All of the above and the below is formulated for symmetric webs, but exterior webs as in [CKM14] or red-green webs as in [TVW17] (red-green paper) work perfectly well using the same strategy. There is one minor difference in the relations: the crossings are defined differently when braiding exterior powers:

$$\begin{array}{c} 1 \quad 1 \\ \nearrow \quad \searrow \\ 1 \quad 1 \end{array} = q^{1-\frac{1}{n}} \left(\begin{array}{c} 1 \quad 1 \\ | \quad | \\ 1 \quad 1 \end{array} - q^{-1} \begin{array}{c} 1 \quad 1 \\ \diagdown \quad \diagup \\ \text{2-dumbbell} \\ \diagup \quad \diagdown \\ 1 \quad 1 \end{array} \right),$$

$$\begin{array}{c} 1 \quad 1 \\ \searrow \quad \nearrow \\ 1 \quad 1 \end{array} = q^{\frac{1}{n}-1} \left(\begin{array}{c} 1 \quad 1 \\ | \quad | \\ 1 \quad 1 \end{array} - q \begin{array}{c} 1 \quad 1 \\ \diagdown \quad \diagup \\ \text{2-dumbbell} \\ \diagup \quad \diagdown \\ 1 \quad 1 \end{array} \right).$$

This apparently minor difference has huge impact, in particular, integrally. For example, while exterior webs fit perfectly to tilting modules (see e.g. [Eli15] and [AST18]), symmetric webs do not have any such interpretation known to the authors.

More details on minimal and integral exterior and red-green webs can be found in [Lat21].

3. EQUIVALENCE THEOREM

We now turn to representation theory and we explain how webs describe the category of finite-dimensional modules over the quantum general linear group.

3A. The quantum general linear group and its idempotent form. We will use $\epsilon_i = (0, \dots, 1, \dots, 0) \in \mathbb{Z}^m$, where 1 is in the i -th coordinate. For $i = 1, \dots, m-1$, let $\alpha_i = \epsilon_i - \epsilon_{i+1} = (0, \dots, 1, -1, \dots, 0) \in \mathbb{Z}^m$. Moreover, recall that the Euclidean inner product on \mathbb{Z}^m is given by $(\epsilon_i, \epsilon_j) = \delta_{i,j}$.

Definition 3A.1. For $m \in \mathbb{Z}_{>1}$, the quantum general linear group $U_q(\mathfrak{gl}_m)$ is the associative, unital $\mathbb{k}(q)$ -algebra generated by L_i and L_i^{-1} , for $i = 1, \dots, m$, and E_i, F_i , for $i = 1, \dots, m-1$, subject to the following relations (for all admissible indices):

$$\begin{aligned}
L_{i_1}L_{i_2} &= L_{i_2}L_{i_1}, \\
L_iL_i^{-1} &= L_i^{-1}L_i = 1, \\
L_{i_1}E_{i_2} &= q^{(\epsilon_{i_1, \alpha_{i_2}})}E_{i_2}L_{i_1}, \\
L_{i_1}F_{i_2} &= q^{-(\epsilon_{i_1, \alpha_{i_2}})}F_{i_2}L_{i_1}, \\
E_{i_1}F_{i_2} - F_{i_2}E_{i_1} &= \delta_{i_1, i_2} \frac{L_{i_1}L_{i_1+1}^{-1} - L_{i_1}^{-1}L_{i_1+1}}{q - q^{-1}}, \\
E_{i_1}^2E_{i_2} - [2]E_{i_1}E_{i_2}E_{i_1} + E_{i_2}E_{i_1}^2 &= 0, \text{ if } |i_1 - i_2| = 1, E_{i_1}E_{i_2} = E_{i_2}E_{i_1}, \text{ else,} \\
F_{i_1}^2F_{i_2} - [2]F_{i_1}F_{i_2}F_{i_1} + F_{i_2}F_{i_1}^2 &= 0, \text{ if } |i_1 - i_2| = 1, F_{i_1}F_{i_2} = F_{i_2}F_{i_1}, \text{ else.}
\end{aligned}$$

The last two relations are called the (quantum) *Serre relations*.

Definition 3A.2. For $m \in \mathbb{Z}_{>1}$ the *quantum special linear algebra* $U_q(\mathfrak{sl}_m)$ is the subalgebra of $U_q(\mathfrak{gl}_m)$ generated by $E_i, F_i, K_i = L_iL_{i+1}^{-1}$ and $K_i^{-1} = L_{i+1}L_i^{-1}$ for $i = 1, \dots, m-1$.

We can endow $U_q(\mathfrak{gl}_m)$ with a Hopf algebra structure (which will be used throughout this paper), where the coproduct Δ is given by

$$\begin{aligned}
(3A.3) \quad \Delta(E_i) &= E_i \otimes L_iL_{i+1}^{-1} + 1 \otimes E_i, \\
\Delta(F_i) &= F_i \otimes 1 + L_i^{-1}L_{i+1} \otimes F_i \text{ and} \\
\Delta(L_i^{\pm 1}) &= L_i^{\pm 1} \otimes L_i^{\pm 1}.
\end{aligned}$$

The antipode and counit are given by

$$\begin{aligned}
S(E_i) &= -E_iL_i^{-1}L_{i+1}, \quad S(F_i) = -L_iL_{i+1}^{-1}F_i, \quad S(L_i^{\pm 1}) = L_i^{\mp 1} \\
\epsilon(E_i) &= \epsilon(F_i) = 0 \text{ and } \epsilon(L_i^{\pm 1}) = 1.
\end{aligned}$$

The subalgebra $U_q(\mathfrak{sl}_m)$ inherits the Hopf algebra structure from $U_q(\mathfrak{gl}_m)$. Recall that from the Hopf algebra structure follows the existence of the trivial representation. It also allows us to extend actions to tensor products of representations. Now, note that the antipode is invertible and the condition below is satisfied.

$$(3A.4) \quad S^2(h) = K_{2\rho}hK_{2\rho}^{-1},$$

for every $h \in U_q(\mathfrak{gl}_m)$, where $K_{2\rho} = K_1^{m-1}K_2^{m-2} \dots K_{m-1}$.

The following representation of $U_q(\mathfrak{gl}_m)$ is of particular interest for us.

Definition 3A.5. The *standard representation* \mathbb{k}_q^m of $U_q(\mathfrak{gl}_m)$ is the m -dimensional $\mathbb{k}(q)$ -vector space with basis b_1, \dots, b_m , where

$$\begin{aligned}
L_ib_i &= qb_i, \quad L_i^{-1}b_i = q^{-1}b_i, \quad L_i^{\pm 1}b_j = b_j, \quad j \neq i, \\
E_{i-1}b_i &= b_{i-1}, \quad E_ib_j = 0, \text{ if } i \neq j-1, \\
F_ib_i &= b_{i+1}, \quad F_ib_j = 0, \text{ if } i \neq j.
\end{aligned}$$

Note that this is the quantum version of the standard (vector) representation of GL_m .

We will later need *Lusztig's idempotent form* of $U_q(\mathfrak{gl}_m)$. The idea is to add to $U_q(\mathfrak{gl}_m)$ an orthogonal system of idempotents in order to view this algebra as a category. Recall that (integral) \mathfrak{gl}_m -weights are tuples $\vec{k} = (k_1, \dots, k_m)$ in \mathbb{Z}^m . We define the *divided powers*

$$F_i^{(j)} = \frac{F_i^j}{[j]!} \text{ and } E_i^{(j)} = \frac{E_i^j}{[j]!}.$$

Definition 3A.6. The category $\dot{U}_q(\mathfrak{gl}_m)$ is the $\mathbb{Z}[q, q^{-1}]$ -linear category with objects the \mathfrak{gl}_m -weights $\vec{k} = (k_1, \dots, k_m) \in \mathbb{Z}^m$. The identity morphism of \vec{k} is denoted by $\mathbf{1}_{\vec{k}}$ and the morphism spaces are denoted by $\mathbf{1}_{\vec{l}} \dot{U}_q(\mathfrak{gl}_m) \mathbf{1}_{\vec{k}}$. The morphisms are generated by $E_i^{(r)} \mathbf{1}_{\vec{k} + r\alpha_i} \dot{U}_q(\mathfrak{gl}_m) \mathbf{1}_{\vec{k}}$ and $F_i^{(r)} \mathbf{1}_{\vec{k} - r\alpha_i} \dot{U}_q(\mathfrak{gl}_m) \mathbf{1}_{\vec{k}}$, $r \in \mathbb{N}$ (here $\alpha_i = (0, \dots, 1, -1, \dots, 0) \in \mathbb{Z}^m$ as before). Note that $\text{Hom}(\vec{k}, \vec{l}) = 0$ unless $\sum k_i = \sum l_i$. These generating morphisms satisfy the following relations

$$(3A.7) \quad F_{i_1}^{(j_1)} F_{i_2}^{(j_2)} \mathbf{1}_{\vec{k}} = F_{i_2}^{(j_2)} F_{i_1}^{(j_1)} \mathbf{1}_{\vec{k}}, \text{ if } |i_1 - i_2| > 1,$$

$$(3A.8) \quad F_{i_1}^{(j_1)} E_{i_2}^{(j_2)} \mathbf{1}_{\vec{k}} = E_{i_2}^{(j_2)} F_{i_1}^{(j_1)} \mathbf{1}_{\vec{k}}, \text{ if } |i_1 - i_2| > 0,$$

$$(3A.9) \quad F_{i_1} F_{i_2} F_{i_1} \mathbf{1}_{\vec{k}} = (F_{i_1}^{(2)} F_{i_2} + F_{i_2} F_{i_1}^{(2)}) \mathbf{1}_{\vec{k}}, \text{ if } |i_1 - i_2| = 1,$$

$$(3A.10) \quad F_i^{(j_1)} F_i^{(j_2)} \mathbf{1}_{\vec{k}} = \begin{bmatrix} j_1 + j_2 \\ j_1 \end{bmatrix} F_i^{(j_1 + j_2)} \mathbf{1}_{\vec{k}},$$

$$(3A.11) \quad E_i^{(j_2)} F_i^{(j_1)} \mathbf{1}_{\vec{k}} = \sum_{j'} \begin{bmatrix} k_i - j_1 - k_{i+1} + j_2 \\ j' \end{bmatrix} F_i^{(j_1 - j')} E_i^{(j_2 - j')} \mathbf{1}_{\vec{k}},$$

$$(3A.12) \quad E_i^{(j)} \mathbf{1}_{\vec{k}} = \mathbf{1}_{\vec{k} + j\alpha_i} E_i^{(j)}, \quad F_i^{(j)} \mathbf{1}_{\vec{k}} = \mathbf{1}_{\vec{k} - j\alpha_i} F_i^{(j)}$$

and their analogues for $E_i^{(j)}$ (when the weight is clear from the context we write $E_i^{(j)}$ instead of $E_i^{(j)} \mathbf{1}_{\vec{k}}$ in the first, third and fourth relation) Relation Equation 3A.9 is called the *Serre relation*.

3B. Quantum symmetric Howe functors. Let $\text{Sym}_q^k \mathbb{k}_q^n$ be the simple $U_q(\mathfrak{gl}_m)$ -module of highest weight $(k, 0, \dots, 0)$. It has a basis given by

$$y_{j_1} \otimes \dots \otimes y_{j_k}, \text{ for } 1 \leq j_1 \leq \dots \leq j_k \leq n,$$

where $\{y_1, \dots, y_n\}$ is a basis of \mathbb{k}_q^n (see [BZ08]) and its dimension is $\binom{n+k-1}{k}$. The following is a consequence of quantum symmetric Howe duality (Theorem 2.6 in [RT16]).

Corollary 3B.1. ([RT16, Theorem 2.6].) *There exists a functor*

$$\Phi_{m,n} : \dot{U}_q(\mathfrak{gl}_m) \rightarrow U_q(\mathfrak{gl}_n)\text{-fdMod}_S,$$

which sends a \mathfrak{gl}_m -weight $\vec{k} = (k_1, \dots, k_m) \in \mathbb{Z}_{\geq 0}^m$ to the $U_q(\mathfrak{gl}_n)$ -module $\text{Sym}_q^{k_1} \otimes \dots \otimes \text{Sym}_q^{k_m}$ and morphisms $X \in \mathbf{1}_{\vec{l}} \dot{U}_q(\mathfrak{gl}_m) \mathbf{1}_{\vec{k}}$ to $f_{\vec{k}}^{\vec{l}}(X)$. The \mathfrak{gl}_m -weights with negative entries are sent to the zero module. This functor is moreover surjective on Hom-spaces as in equation Equation 3B.2:

$$(3B.2) \quad f_{\vec{k}}^{\vec{l}} : \mathbf{1}_{\vec{l}} \dot{U}_q(\mathfrak{gl}_m) \mathbf{1}_{\vec{k}} \longrightarrow \text{Hom}_{U_q(\mathfrak{gl}_n)}(\text{Sym}_q^{k_1} \otimes \dots \otimes \text{Sym}_q^{k_m}, \text{Sym}_q^{l_1} \otimes \dots \otimes \text{Sym}_q^{l_m})$$

for any two $\vec{k}, \vec{l} \in \mathbb{Z}_{\geq 0}^m$ such that $\sum_{i=0}^m k_i = \sum_{i=0}^m l_i$, meaning that it is full.

By dualising [RT16, Theorem 2.6] we obtain:

Corollary 3B.3. *There exists a functor*

$$\Phi_{m,n}^* : \dot{U}_q(\mathfrak{gl}_m) \rightarrow U_q(\mathfrak{gl}_n)\text{-fdMod}_{S^*},$$

which sends a \mathfrak{gl}_m -weight $\vec{k} = (-k_1, \dots, -k_m) \in \mathbb{Z}_{\leq 0}^m$ to the $U_q(\mathfrak{gl}_n)$ -module $(\text{Sym}_q^{k_m})^* \otimes \dots \otimes (\text{Sym}_q^{k_1})^*$ and morphisms $X \in \mathbf{1}_{\vec{l}} \dot{U}_q(\mathfrak{gl}_m) \mathbf{1}_{\vec{k}}$ to $(f_{\vec{k}}^{\vec{l}})^*(X)$. This functor is surjective on Hom-spaces analogous to those in Equation 3B.2.

We refer to $\Phi_{m,n}$ and $\Phi_{m,n}^*$ as the q -symmetric Howe functors.

3C. The functor Γ_{sym} . We start by recalling a ladder-type functor which has appeared several times in various forms in the literature. The main idea goes back to [CKM14].

Lemma 3C.1. ([RT16, Lemma 2.17].) *For each $m \in \mathbb{Z}_{\geq 0}$, there exists a functor*

$$A_{m,n} : \dot{U}_q(\mathfrak{gl}_m) \rightarrow \mathbf{SWeb}_{\uparrow}(\mathfrak{gl}_n)$$

which sends a \mathfrak{gl}_m -weight $\vec{k} \in \mathbb{Z}_{\geq 0}^m$ to the sequence obtained by removing all 0's, and sends all other objects \vec{k} of $\dot{U}_q(\mathfrak{gl}_m)$ to the zero object. This functor is determined on morphisms by the assignment

$$(3C.2) \quad A_{m,n}(F_i^{(j)} \mathbf{1}_{\vec{k}}) = \begin{array}{c} k_1 \quad k_i - j \quad k_{i+1} + j \quad k_m \\ \uparrow \quad \dots \quad \uparrow \quad \xrightarrow{j} \quad \uparrow \quad \dots \quad \uparrow \\ k_1 \quad k_i \quad k_{i+1} \quad k_m \end{array}, \quad A_{m,n}(E_i^{(j)} \mathbf{1}_{\vec{k}}) = \begin{array}{c} k_1 \quad k_i + j \quad k_{i+1} - j \quad k_m \\ \uparrow \quad \dots \quad \uparrow \quad \xleftarrow{j} \quad \uparrow \quad \dots \quad \uparrow \\ k_1 \quad k_i \quad k_{i+1} \quad k_m \end{array}$$

where we erase any zero labelled edges in the diagrams depicting the images. \square

Let us give some necessary $U_q(\mathfrak{gl}_n)$ -intertwiners, using a thin version of the notations in [RW20, Appendix B].

Definition 3C.3. The *thin projection, inclusion, evaluation and coevaluation maps* are defined as

$$\begin{aligned} m_{1,1} &: \text{Sym}_q^1 \otimes \text{Sym}_q^1 \rightarrow \text{Sym}_q^2 \\ b_i \otimes b_j &\mapsto \begin{cases} b_i \otimes b_j, & \text{if } i \leq j, \\ qb_j \otimes b_i, & \text{if } i > j; \end{cases} \\ s_{1,1} &: \text{Sym}_q^2 \rightarrow \text{Sym}_q^1 \otimes \text{Sym}_q^1 \\ b_i \otimes b_j &\mapsto \begin{cases} q^{-1}b_i \otimes b_j + b_j \otimes b_i, & \text{if } i < j, \\ [2]b_i \otimes b_i, & \text{if } i = j; \end{cases} \\ ev_1^{\text{left}} &: (\text{Sym}_q^1)^* \otimes \text{Sym}_q^1 \rightarrow \mathbb{k}_q \\ b_i^* \otimes b_j &\mapsto b_i^*(b_j); \\ coev_1^{\text{left}} &: \mathbb{k}_q \rightarrow \text{Sym}_q^1 \otimes (\text{Sym}_q^1)^* \\ 1 &\mapsto \sum_{i=1}^n b_i \otimes b_i^*. \end{aligned}$$

Lemma 3C.4. *The maps $m_{1,1}$, $s_{1,1}$, ev_1^{left} , $coev_1^{\text{left}}$ are $U_q(\mathfrak{gl}_n)$ -intertwiners.*

Recall now the q -symmetric Howe functors from subsection 3B. We use them to define our main functor.

Definition 3C.5. The functor

$$\Gamma_{\text{sym}} : \mathbf{SWeb}_{\uparrow, \downarrow}(\mathfrak{gl}_n) \rightarrow U_q(\mathfrak{gl}_n)\text{-fdMod}_{S, S^*}$$

is defined as follows.

- On objects k_{\uparrow} and k_{\downarrow} , $k \in \mathbb{Z}_{\geq 0}$ we set

$$\Gamma_{\text{sym}}(k_{\uparrow}) = \text{Sym}_q^k \quad \text{and} \quad \Gamma_{\text{sym}}(k_{\downarrow}) = (\text{Sym}_q^k)^*.$$

By convention, we send the zero object to the zero module and the empty tuple to the trivial $U_q(\mathfrak{gl}_n)$ -module.

- On morphisms, we send the generating morphisms of $\mathbf{SWeb}_{\uparrow,\downarrow}(\mathfrak{gl}_n)$ to the following $U_q(\mathfrak{gl}_n)$ -intertwiners and we extend monoidally

$$\begin{aligned} \Gamma_{\text{sym}} \left(\begin{array}{c} k+1 \\ \text{red tree} \\ k \quad 1 \end{array} \right) &= \Phi_{2,n}(E_1^{(1)} \mathbf{1}_{(k,1)}), & \Gamma_{\text{sym}} \left(\begin{array}{c} k \quad 1 \\ \text{black tree} \\ k+1 \end{array} \right) &= \Phi_{2,n}(F_1^{(1)} \mathbf{1}_{(k+1,0)}), \\ \Gamma_{\text{sym}} \left(\begin{array}{c} k+1 \\ \text{red tree} \\ k \quad 1 \end{array} \right) &= \Phi_{2,n}^*(F_1^{(1)} \mathbf{1}_{(-1,-k)}), & \Gamma_{\text{sym}} \left(\begin{array}{c} k \quad 1 \\ \text{black tree} \\ k+1 \end{array} \right) &= \Phi_{2,n}^*(E_1^{(1)} \mathbf{1}_{(0,-1-k)}), \\ \Gamma_{\text{sym}} \left(\begin{array}{c} \text{cup} \\ 1 \quad 1 \end{array} \right) &= ev_1^{\text{left}}, & \Gamma_{\text{sym}} \left(\begin{array}{c} \text{cap} \\ 1 \quad 1 \end{array} \right) &= coev_1^{\text{left}}. \end{aligned}$$

We now show that the functor Γ_{sym} is actually well-defined. Here it will become clear why we constructed the diagrammatic category the way we did.

Lemma 3C.6. *The functor*

$$\Gamma_{\text{sym}} : \mathbf{SWeb}_{\uparrow,\downarrow}(\mathfrak{gl}_n) \rightarrow U_q(\mathfrak{gl}_n)\text{-fdMod}_{S,S^*}$$

is well-defined.

Proof. Let us show that the analogues of the relations from [Definition 2A.23](#) hold in $U_q(\mathfrak{gl}_n)\text{-fdMod}$. The relations [Equation 2A.8](#) and [Equation 2A.9](#) hold in $U_q(\mathfrak{gl}_n)\text{-fdMod}$ as a consequence of q-Howe duality, namely of [Corollary 3B.1](#) since they come from relations in $\check{U}_q(\mathfrak{gl}_m)$. An easy calculation identifies the morphisms associated to the right-hand sides in [Definition 2A.2](#) as

$$-q^{-1-\frac{1}{n}} \text{id}_1 \otimes \text{id}_1 + q^{-\frac{1}{n}} s_{1,1} \circ m_{1,1} \quad \text{and} \quad -q^{-1+\frac{1}{n}} \text{id}_1 \otimes \text{id}_1 + q^{\frac{1}{n}} s_{1,1} \circ m_{1,1},$$

respectively. These morphisms are invertible, and composing them with evaluation and coevaluation maps does not change that property, meaning that [Equation 2A.24](#) also holds. Now, a simple computation shows that [Equation 2A.25](#) holds in $U_q(\mathfrak{gl}_n)\text{-fdMod}$. Indeed, from [Definition 3C.3](#), we have

$$(ev_1^{\text{left}} \circ \text{id}_1) \circ (\text{id}_1 \circ coev_1^{\text{left}})(b_j^* \otimes 1) = (ev_1^{\text{left}} \circ \text{id}_1)(b_j^* \otimes \sum_{i=1}^n b_i \otimes b_i^*) = \sum_{i=1}^n b_j^*(b_i) \otimes b_i^* = 1 \otimes b_j^*,$$

meaning that $(ev_1^{\text{left}} \circ \text{id}_1) \circ (\text{id}_1 \circ coev_1^{\text{left}}) = \text{id}_1$, which is exactly the representation theoretical version of the zigzag relation from [Equation 2A.25](#). Showing relation [Equation 2A.26](#) is again a brute force computation which we will omit here, see [\[Lat21\]](#) for details. Finally, relation [Equation 2A.27](#) holds because of our definition of ev_1^{left} :

$$ev_1^{\text{left}} \circ coev_1^{\text{right}}(1) = ev_1^{\text{left}} \left(\sum_{i=1}^n q^{-n+2i-1} b_i^* \otimes b_i \right) = q^{-n+1} + q^{-n+3} + \dots + q^{n-1} = [n].$$

The proof completes. □

3D. Relating the two web categories. Now we want to identify $\mathbf{SWeb}_{\uparrow}(\mathfrak{gl}_n)$ as a full subcategory of $\mathbf{SWeb}_{\uparrow,\downarrow}(\mathfrak{gl}_n)$. Recall [Proposition 2B.15](#). In particular, from this proposition we can assume that the boundaries of a web in $\mathbf{SWeb}_{\uparrow,\downarrow}(\mathfrak{gl}_n)$ are upward pointing. Below we show that we have an even stronger connection between our two symmetric web categories.

Theorem 3D.1. *There exists a fully faithful functor of braided monoidal categories*

$$G : \mathbf{SWeb}_{\uparrow}(\mathfrak{gl}_n) \rightarrow \mathbf{SWeb}_{\uparrow,\downarrow}(\mathfrak{gl}_n)$$

sending objects and morphism from $\mathbf{SWeb}_{\uparrow}(\mathfrak{gl}_n)$ to objects and morphisms of the same name in $\mathbf{SWeb}_{\uparrow,\downarrow}(\mathfrak{gl}_n)$.

Proof. We give a line-to-line adaptation of [BDK20, Theorem 7.5.1]. First, it is clear that this functor is well-defined because the defining relations of $\mathbf{SWeb}_\uparrow(\mathfrak{gl}_n)$ hold in $\mathbf{SWeb}_{\uparrow,\downarrow}(\mathfrak{gl}_n)$. Also, they have the same monoidal braided structures by construction. Remains to prove fully faithfulness. Let $k_\uparrow, l_\uparrow \in \text{Obj}(\mathbf{SWeb}_\uparrow(\mathfrak{gl}_n))$ and w a web in $\text{Hom}_{\mathbf{SWeb}_{\uparrow,\downarrow}(\mathfrak{gl}_n)}(k_\uparrow, l_\uparrow)$. We want to show that

$$\text{Hom}_{\mathbf{SWeb}_\uparrow(\mathfrak{gl}_n)}(k_\uparrow, l_\uparrow) \cong \text{Hom}_{\mathbf{SWeb}_{\uparrow,\downarrow}(\mathfrak{gl}_n)}(G(k_\uparrow), G(l_\uparrow)).$$

Let us first show fullness. Note that the bottom and top of a web in $\mathbf{SWeb}_{\uparrow,\downarrow}(\mathfrak{gl}_n)$ are upward pointing but in the middle of it we can have both upward and downward pointing merges, splits, cups, caps and crossings. We use relations Equation 2A.25 and Equation 2A.27 to straighten zigzags and to remove circles. Further, we use Corollary 2B.4 to remove any downward pointing merges and splits. From Lemma 2B.19 and Lemma 2B.11 we can slide crossing, cups and caps through merges and splits putting the former below the later. Proceeding inductively on the total number of crossings, we can therefore write w as a linear combination of diagrams of the form $k_\uparrow \rightarrow l_\uparrow$, where each diagram has an upper part and a lower part. The upper part consists only of upward pointing merges and splits, whereas the lower part consists only of cups, caps and crossings (both upward and downward pointing). The webs of the upper part are clearly morphisms in $\mathbf{SWeb}_\uparrow(\mathfrak{gl}_n)$. In the lower part, after removing any circles, the remaining webs are (compositions of) crossings or compositions as in the Reidemeister 1 moves. Note that in the bottom part we have a geometric braid, which can be turned upwards. Now we use the three types of Reidemeister moves, in particular, we use Lemma 2B.18 to write the compositions of crossings with cups and caps as scalar multiples of identities. In a nutshell, every web of form $k_\uparrow \rightarrow l_\uparrow$ in $\mathbf{SWeb}_{\uparrow,\downarrow}(\mathfrak{gl}_n)$ can be written as a linear combination of diagrams of the form $k_\uparrow \rightarrow l_\uparrow$ in $\mathbf{SWeb}_\uparrow(\mathfrak{gl}_n)$. This shows fullness of G . Finally, consider the diagram

$$\begin{array}{ccc} \mathbf{SWeb}_\uparrow(\mathfrak{gl}_n) & \xrightarrow{\Gamma_{\text{sym}}} & U_q(\mathfrak{gl}_n)\text{-fdMod} \\ & \searrow G & \nearrow \Gamma_{\text{sym}} \\ & \mathbf{SWeb}_{\uparrow,\downarrow}(\mathfrak{gl}_n) & \end{array}$$

It commutes by definition. Moreover, the top functor is faithful from Lemma 3E.3. This then implies that G is faithful. \square

3E. Proof that Γ_{sym} is an equivalence of categories. We extend our functor by passing to the additive Karoubi envelopes of our categories. We abuse notation and continue denoting it by Γ_{sym}

$$\Gamma_{\text{sym}} : \mathbf{Kar}(\mathbf{SWeb}_{\uparrow,\downarrow}(\mathfrak{gl}_n)) \rightarrow U_q(\mathfrak{gl}_n)\text{-fdMod}.$$

We are finally ready to prove the following.

Theorem 3E.1. (*Equivalence Theorem for symmetric webs*) *The functor*

$$\Gamma_{\text{sym}} : \mathbf{SWeb}_{\uparrow,\downarrow}(\mathfrak{gl}_n) \rightarrow U_q(\mathfrak{gl}_n)\text{-fdMod}_{S,S^*}$$

is fully faithful and

$$\Gamma_{\text{sym}} : \mathbf{Kar}(\mathbf{SWeb}_{\uparrow,\downarrow}(\mathfrak{gl}_n)) \rightarrow U_q(\mathfrak{gl}_n)\text{-fdMod}$$

is an equivalence of braided pivotal categories.

Proof. We have already proved that Γ_{sym} is well-defined in Lemma 3C.6. Now we show that it is fully faithful and essentially surjective after passing to Karoubi envelopes.

Fully faithful. We have to show that for $\vec{k}, \vec{l} \in \mathbb{Z}^m$, $m > 0$, we have

$$\text{Hom}_{\mathbf{SWeb}_{\uparrow,\downarrow}(\mathfrak{gl}_n)}(\vec{k}, \vec{l}) \cong \text{Hom}_{U_q(\mathfrak{gl}_n)\text{-fdMod}}(\Gamma_{\text{sym}}(\vec{k}), \Gamma_{\text{sym}}(\vec{l})).$$

From Proposition 2B.15 and Theorem 3D.1, it suffices to show this for upward pointing webs only and we have proved the later in Lemma 3E.3.

Essentially surjective. This follows from the definition of Γ_{sym} and the fact that every irreducible $U_q(\mathfrak{gl}_n)$ -module appears in a suitable tensor product of symmetric powers of the standard representation and their duals. Indeed, let V be an irreducible $U_q(\mathfrak{gl}_n)$ -module appearing as a direct

summand in $\bigotimes_i \text{Sym}_q^{k_i} \otimes \bigotimes_j (\text{Sym}_q^{k_j})^*$. Then $\Gamma_{\text{sym}}(\bigotimes_i k_{i\uparrow} \otimes \bigotimes_j k_{j\downarrow}) = \bigotimes_i \text{Sym}_q^{k_i} \otimes \bigotimes_j (\text{Sym}_q^{k_j})^*$. Since both sides are now idempotent complete, tensor products decompose into irreducible objects and such decompositions are unique up to permutation. Thus, there exists a direct summand of $\bigotimes_i k_{i\uparrow} \otimes \bigotimes_j k_{j\downarrow}$ that is sent to V by Γ_{sym} .

This finishes the proof that Γ_{sym} is an equivalence of categories. Finally, after adapting Section 3.1 of [RT16] and Section 6 of [CKM14] to our setting we have that Γ_{sym} is an equivalence of pivotal braided categories. \square

Now we give the connection between the three functors of this section. The following is a generalisation of Corollary 2.22 in [RT16].

Lemma 3E.2. *The diagram below commutes*

$$\begin{array}{ccc} \dot{U}_q(\mathfrak{gl}_m) & \xrightarrow{\Phi_{m,n}} & U_q(\mathfrak{gl}_n)\text{-fdMod} \\ & \searrow A_{m,n} & \nearrow \Gamma_{\text{sym}} \\ & & \mathbf{SWeb}_{\uparrow}(\mathfrak{gl}_n) \end{array}$$

The following lemma is one of the main ingredients for proving Theorem 3E.1. Note that it concerns upward pointing webs only.

Lemma 3E.3. *The functor*

$$\Gamma_{\text{sym}} : \mathbf{SWeb}_{\uparrow}(\mathfrak{gl}_n) \rightarrow U_q(\mathfrak{gl}_n)\text{-fdMod}_S$$

is fully faithful.

Proof. We have to show that for tuples $k_{\uparrow} = (k_1, \dots, k_m)_{\uparrow} \in \mathbb{Z}_{\geq 0}^m$ and $l_{\uparrow} = (l_1, \dots, l_{m'})_{\uparrow} \in \mathbb{Z}_{\geq 0}^{m'}$ we have

$$\text{Hom}_{\mathbf{SWeb}_{\uparrow}(\mathfrak{gl}_n)}(k_{\uparrow}, l_{\uparrow}) \cong \text{Hom}_{U_q(\mathfrak{gl}_n)\text{-fdMod}}(\Gamma_{\text{sym}}(k_{\uparrow}), \Gamma_{\text{sym}}(l_{\uparrow})).$$

Note that we can assume that $m = m'$, otherwise we add zeros to the shorter tuple. Now, Γ_{sym} by definition comes from a q -Howe functor $\Phi_{m,n}$, for $m \in \mathbb{Z}_{\geq 0}$ big enough.

Surjectivity: In the case $\sum_{i=1}^m k_i = \sum_{i=1}^m l_i$ surjectivity follows from Lemma 3E.2 and the fact that q -symmetric Howe functor $\Phi_{m,n}$ is surjective on these Hom-spaces, whereas for $\sum_{i=1}^m k_i \neq \sum_{i=1}^m l_i$ we have zero on both sides.

Injectivity: By surjectivity and finite-dimensionality of the involved spaces it suffices to show that

$$(3E.4) \quad \dim \text{Hom}_{\mathbf{SWeb}_{\uparrow}(\mathfrak{gl}_n)}(k_{\uparrow}, l_{\uparrow}) = \dim \text{Hom}_{U_q(\mathfrak{gl}_n)\text{-fdMod}}(\Gamma_{\text{sym}}(k_{\uparrow}), \Gamma_{\text{sym}}(l_{\uparrow})).$$

We prove this first for $k_{\uparrow} = (1, \dots, 1)_{\uparrow} = l_{\uparrow}$. In this case, recall that in $U_q(\mathfrak{gl}_n)\text{-fdMod}$ we have

$$\text{Sym}_q^1 \mathbb{k}_q^n \cong \bigwedge_q^1 \mathbb{k}_q^n \cong \mathbb{k}_q^n.$$

Further, we have

$$(3E.5) \quad \dim \text{End}_{U_q(\mathfrak{gl}_n)\text{-fdMod}}(\mathbb{k}_q^n \otimes \dots \otimes \mathbb{k}_q^n) = \dim \text{End}_{U_q(\mathfrak{sl}_n)\text{-fdMod}}(\mathbb{k}_q^n \otimes \dots \otimes \mathbb{k}_q^n),$$

since every irreducible $U_q(\mathfrak{sl}_n)$ -module comes from a restriction of an irreducible $U_q(\mathfrak{gl}_n)$ -module.

Now, from Proposition 2C.6 we have that

$$(3E.6) \quad \dim \text{End}_{\mathbf{SWeb}_{\uparrow}(\mathfrak{gl}_n)}(1 \otimes \dots \otimes 1) = \dim \text{End}_{\mathbf{EWeb}_{\uparrow, \downarrow}(\mathfrak{sl}_n)}(1 \otimes \dots \otimes 1).$$

Finally, there exists an equivalence of categories ([CKM14], Theorem 3.3.1)

$$\mathbf{EWeb}_{\uparrow, \downarrow}(\mathfrak{sl}_n) \rightarrow U_q(\mathfrak{sl}_n)\text{-fdMod}.$$

Combining this equivalence with Equation 3E.5 and Equation 3E.6 shows that the equality in Equation 3E.4 holds for $k_{\uparrow} = (1, \dots, 1)_{\uparrow} = l_{\uparrow}$. For the general case, we proceed as in the proof of

The reason why we are particularly interested in closed webs becomes evident from the lemma below.

Lemma 4.4. *We have $\text{End}(\emptyset) \cong \mathbb{k}(q^{\frac{1}{n}})$.*

Proof. Note that the statement is equivalent to the claim that to any closed web we can assign a scalar, which is the result of the evaluation rules in the corresponding web category. From [Theorem 3E.1](#), it suffices to prove the statement in the representation theoretical side. The claim then follows by a version of Schur's lemma. Precisely, although our ground field might not be algebraically closed, the endomorphism space of $\text{Sym}_q^0 = \mathbb{k}_q$ is trivial by [[APW91](#), Corollary 7.4]. \square

Definition 4.5. We refer to the scalar $\langle w, w' \rangle$ as the *evaluation* of the web w with respect to w' .

Definition 4.6. Let w_1 and w_2 be webs. Two web relations $w_1 = r_1(w_1)$, $w_2 = r_2(w_2)$ are called *dependent* if w_1 and w_2 have the same boundary up to bending and $\langle w_1, w' \rangle = \langle w_2, w' \rangle$, for every w' . Otherwise we call them *independent*. (Here the webs w_1 and w_2 are allowed to be linear combinations of webs.)

We are now ready to state and prove the Minimality Theorem for symmetric webs, which can be proved similarly for exterior and green-red webs.

Theorem 4.7. (*Minimality Theorem for symmetric webs*) *We have the following:*

1. The relations [Equation 2A.8-Equation 2A.27](#) are sufficient to prove [Theorem 3E.1](#).
2. The relations [Equation 2A.8-Equation 2A.27](#) are independent.
3. The generators of $\mathbf{SWeb}_{\uparrow, \downarrow}(\mathfrak{gl}_n)$ cannot be made thinner while still having a fully faithful functor to $U_q(\mathfrak{gl}_n)\text{-fdMod}_{S, S^*}$.

Proof.

1. Throughout we have used only relations [Equation 2A.8-Equation 2A.27](#) to show that Γ_{sym} is an equivalence of categories.
2. We list the boundary points of each of the relations. The relations [Equation 2A.8-Equation 2A.24](#) have all four boundary points, [Equation 2A.25](#) has two, [Equation 2A.26](#) has three and [Equation 2A.27](#) has zero. This means that the relations [Equation 2A.25](#), [Equation 2A.26](#) and [Equation 2A.27](#) are incomparable to each other and to other relations. To show that [Equation 2A.8](#) and [Equation 2A.24](#) are independent we bend the webs such that all the boundary points are at the top (see also [Proposition 2B.15](#)). Then these two relations have different boundary orientations, so they are independent. Similarly, relations [Equation 2A.8](#) and [Equation 2A.9](#) are independent. Finally, we need to compare [Equation 2A.9](#) and [Equation 2A.24](#), however only for $k = l = 1$. The bend versions are

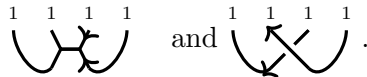

We close these webs (using the same closure) as below,

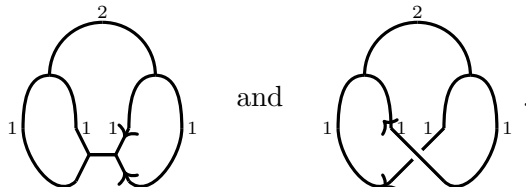

After evaluating, using the digon removal and the circle evaluation, we get $[2]^2 \begin{bmatrix} n+1 \\ 2 \end{bmatrix}$ for the first web. On the other hand, using [Lemma 2B.17](#), digon removal and the circle evaluation we get $q^{-\frac{1}{n}+1} [2] \begin{bmatrix} n+1 \\ 2 \end{bmatrix}$ for the second web. These are different scalars meaning that the relations are independent.

3. We show the statement by induction on the complexity. Recall that the “thinnest” generators on $\mathbf{SWeb}_{\uparrow,\downarrow}(\mathfrak{gl}_n)$ are

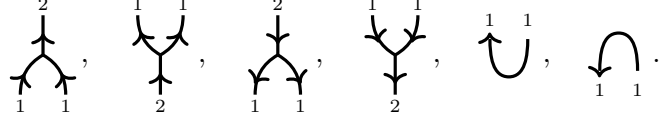

Note that the corresponding Hom-spaces in $U_q(\mathfrak{gl}_n)\text{-fdMod}_{S,S^*}$ are the first non-trivial ones.

Let us inductively assume that we have already shown that the $(k, 1)$ -merge and $(k, 1)$ -split are needed as generators. On the representation theoretical side $(k+1, 1)$ corresponds to $\text{Sym}^{k+1} \otimes \mathbb{k}_q^n$. The later has the summand Sym^{k+2} which we have not seen in any shorter tensor product. In particular, none of the inductively added maps can go through this summand, so we need to add at least two additional maps (corresponding to the splitting of Sym^{k+2} from $\text{Sym}^{k+1} \otimes \mathbb{k}_q^n$) in order for the Hom-space to be of the right dimension. We add the $(k+1, 1)$ -merge and the $(k+1, 1)$ -split. The same arguments work in the dual setting. \square

5. SOME OTHER PROPERTIES OF WEBS

We now point out that webs can be adjusted to work integrally, meaning over $\mathbb{Z}[q^{\frac{1}{n}}, q^{-\frac{1}{n}}]$. By specialisation, this could lead to understanding something about the representation theory in positive characteristic.

Definition 5.1. The free symmetric upward pointing category of integral \mathfrak{gl}_n -webs, denote it by $\mathbf{fSWeb}_{\uparrow}^{\text{int}}(\mathfrak{gl}_n)$, is the $\mathbb{Z}[q^{\frac{1}{n}}, q^{-\frac{1}{n}}]$ -linear category monoidally generated by

- objects $\{k_{\uparrow} \mid k \in \mathbb{Z}_{\geq 0}\}$,
- morphisms

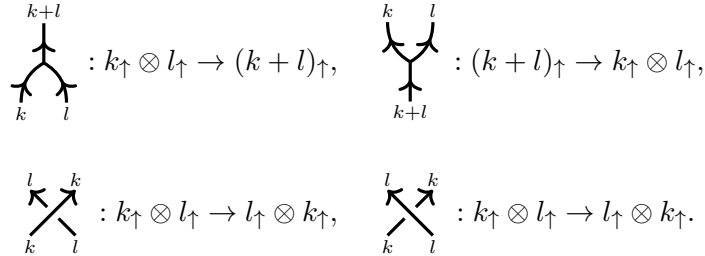

Definition 5.2. The symmetric upward pointing category of integral \mathfrak{gl}_n -webs, denote it by $\mathbf{SWeb}_{\uparrow}^{\text{int}}(\mathfrak{gl}_n)$ is the quotient of $\mathbf{fSWeb}_{\uparrow}^{\text{int}}(\mathfrak{gl}_n)$ by the following relations:

Associativity and coassociativity

$$(5.3) \quad \begin{array}{c} h+m+l \\ \diagup \quad \diagdown \\ h \quad m \quad l \end{array} = \begin{array}{c} h+m+l \\ \diagup \quad \diagdown \\ h \quad m \quad l \end{array} \quad \text{and} \quad \begin{array}{c} h \quad m \quad l \\ \diagdown \quad \diagup \\ h+m+l \end{array} = \begin{array}{c} h \quad m \quad l \\ \diagdown \quad \diagup \\ h+m+l \end{array} .$$

Digon removal

$$(5.4) \quad \begin{array}{c} k+l \\ \diagup \quad \diagdown \\ k \quad l \\ \diagdown \quad \diagup \\ k+l \end{array} = \begin{bmatrix} k+l \\ l \end{bmatrix} \begin{array}{c} k+l \\ \diagup \\ k+l \end{array} .$$

Dumbbell-crossing relations

$$(5.5) \quad \begin{array}{c} r \quad s \\ \diagdown \quad \diagup \\ \text{---} \\ \diagup \quad \diagdown \\ k \quad l \end{array} = \sum_{i-j=k-r} q^{-(k-i)(l-j) + \frac{ij}{n}} \begin{array}{c} r \quad s \\ \diagdown \quad \diagup \\ \text{---} \\ \diagup \quad \diagdown \\ k \quad l \end{array},$$

$$\begin{array}{c} r \quad s \\ \diagdown \quad \diagup \\ \text{---} \\ \diagup \quad \diagdown \\ k \quad l \end{array} = \sum_{i-j=k-r} q^{(k-i)(l-j) - \frac{ij}{n}} \begin{array}{c} r \quad s \\ \diagdown \quad \diagup \\ \text{---} \\ \diagup \quad \diagdown \\ k \quad l \end{array}.$$

The relations in Equation 5.5 are motivated by [BEAEO20, (4.23)]. Note that the crossings can be omitted as generators, as we will show in Lemma 5.7. We only use them above to give a shorter description of the construction. Note also that we do *not* assume that the crossings are invertible. This will be a later consequence. We will actually prove that $\mathbf{SWeb}_\uparrow^{\text{int}}(\mathfrak{gl}_n)$ is a braided category.

Now, since we are working over $\mathbb{Z}[q^{\frac{1}{n}}, q^{-\frac{1}{n}}]$, the digon removal relation Equation 5.4 is *not* an invertible operation. Consequently we cannot use the idea of exploding edges (from the previous chapters) since this requires the inversion of quantum binomials. This is the reason why in Definition 5.2 our web generators are thick to begin with.

We point out here that a lot of the properties of generic webs hold also integrally. One of these is the following.

Lemma 5.6. *Thick square switches hold in $\mathbf{SWeb}_\uparrow^{\text{int}}(\mathfrak{gl}_n)$. Namely,*

$$\begin{array}{c} k-h+g \quad l+h-g \\ \diagdown \quad \diagup \\ \text{---} \\ \diagup \quad \diagdown \\ k \quad l \end{array} = \sum_i \begin{bmatrix} k-l+g-h \\ i \end{bmatrix} \begin{array}{c} k-h+g \quad l-g+h \\ \diagdown \quad \diagup \\ \text{---} \\ \diagup \quad \diagdown \\ k \quad l \end{array},$$

$$\begin{array}{c} k+h-g \quad l-h+g \\ \diagdown \quad \diagup \\ \text{---} \\ \diagup \quad \diagdown \\ k \quad l \end{array} = \sum_i \begin{bmatrix} l-k+g-h \\ i \end{bmatrix} \begin{array}{c} k+h-g \quad l-h+g \\ \diagdown \quad \diagup \\ \text{---} \\ \diagup \quad \diagdown \\ k \quad l \end{array}.$$

Proof. These can be derived from relations [Equation 5.3](#)-[Equation 5.5](#) and q -combinatorics. Indeed, we use relation [Equation 5.5](#) to write the LHS of the first relation as

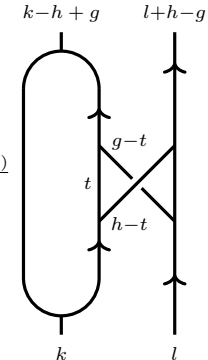
$$\sum_{t=\max(0,g-l)}^{\min(g,h)} q^{-t(l-g+t)+\frac{(h-t)(g-t)}{n}}$$

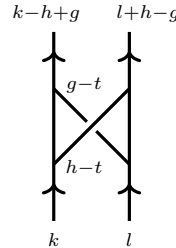
$$\stackrel{\text{Equation 5.3 and Equation 5.4}}{=} \sum_{t=\max(0,g-l)}^{\min(g,h)} q^{-t(l-g+t)+\frac{(g-t)(h-t)}{n}} \begin{bmatrix} k-h+t \\ t \end{bmatrix}$$

Similarly, the RHS is equal to

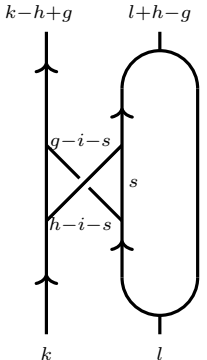
$$\sum_{i=0}^{\min(g,h)} \begin{bmatrix} k-l+g-h \\ i \end{bmatrix} \sum_{s=0}^{\min(g,h)-i} q^{-s(k-h+i+s)+\frac{(g-i-s)(h-i-s)}{n}}$$

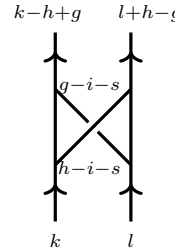
$$= \sum_{i=0}^{\min(g,h)} \begin{bmatrix} k-l+g-h \\ i \end{bmatrix} \sum_{s=0}^{\min(g,h)-i} q^{-s(k-h+i+s)+\frac{(g-i-s)(h-i-s)}{n}} \begin{bmatrix} l-g+i+s \\ s \end{bmatrix}$$

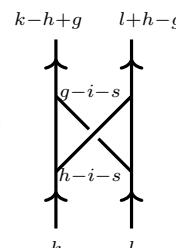
$$\stackrel{[\text{Lat21, Lemma 3.1.6}]}{=} \sum_{i=\max(0,g-l)}^{\min(g,h)} \begin{bmatrix} k-h+i+s \\ i+s \end{bmatrix} q^{-(i+s)(l-g+i+s)+\frac{(g-i-s)(h-i-s)}{n}}$$

$$\text{put } \underline{i+s=t} \quad \sum_{t=\max(0,g-l)}^{\min(g,h)} q^{-t(l-g+t)+\frac{(g-t)(h-t)}{n}} \left[\begin{matrix} k-h+t \\ t \end{matrix} \right] \begin{array}{c} k-h+g \quad l+h-g \\ \begin{array}{c} \uparrow \quad \uparrow \\ \diagdown \quad \diagup \\ \uparrow \quad \uparrow \\ \downarrow \quad \downarrow \\ \uparrow \quad \uparrow \\ k \quad l \end{array} \end{array} .$$

The other square switch relation is proved analogously. \square

Lemma 5.7. *The crossings from Definition 5.2 satisfy the following identities*

$$\begin{array}{c} \begin{array}{c} \nearrow \\ \nwarrow \\ k \quad l \end{array} = q^{-\frac{kl}{n}} \sum_{t=0}^{\min(k,l)} (-q)^{-t} \begin{array}{c} l \quad k \\ \begin{array}{c} \uparrow \quad \uparrow \\ \leftarrow \quad \rightarrow \\ \uparrow \quad \uparrow \\ \leftarrow \quad \rightarrow \\ \uparrow \quad \uparrow \\ k \quad l \end{array} \end{array}, \\ \\ \begin{array}{c} \nwarrow \\ \nearrow \\ l \quad k \end{array} = q^{\frac{kl}{n}} \sum_{t=0}^{\min(k,l)} (-q)^t \begin{array}{c} k \quad l \\ \begin{array}{c} \uparrow \quad \uparrow \\ \leftarrow \quad \rightarrow \\ \uparrow \quad \uparrow \\ \leftarrow \quad \rightarrow \\ \uparrow \quad \uparrow \\ l \quad k \end{array} \end{array}, \end{array}$$

meaning that they are redundant as generators of $\mathbf{SWeb}_\uparrow^{\text{int}}(\mathfrak{gl}_n)$.

The proof of Lemma 5.7 is similar to that of Lemma 5.8. We prove the latter in the end of the section.

Lemma 5.8. *We can deduce relations Equation 5.5 from Equation 5.3, Equation 5.4 and the thick square switches from Lemma 5.6.*

Proof. We show that Equation 5.3, Equation 5.4 and thick square switches from Lemma 5.6 imply the first equality in Equation 5.5. The second equality can be proved similarly. At this point, we give the quantum version of [BEAEO20, Appendix A]. First, note that up to symmetry, it suffices to prove that the following holds in $\mathbf{SWeb}_\uparrow(\mathfrak{gl}_n)$, for $r \geq 0$;

$$\begin{array}{c} \begin{array}{c} l \quad k+r \\ \begin{array}{c} \uparrow \quad \uparrow \\ \diagdown \quad \diagup \\ \uparrow \quad \uparrow \\ \downarrow \quad \downarrow \\ \uparrow \quad \uparrow \\ k \quad l+r \end{array} \end{array} = \sum_{i-j=k-l} q^{-(k-i)(l+r-j)+\frac{ij}{n}} \begin{array}{c} l \quad k+r \\ \begin{array}{c} \uparrow \quad \uparrow \\ \diagdown \quad \diagup \\ \uparrow \quad \uparrow \\ \downarrow \quad \downarrow \\ \uparrow \quad \uparrow \\ k \quad l+r \end{array} \end{array} .$$

For simplicity, we relabel some of the edges above and the final version of relation Equation 5.5 that we are aiming to prove is

$$\begin{array}{c} \begin{array}{c} l \quad k+r \\ \begin{array}{c} \uparrow \quad \uparrow \\ \diagdown \quad \diagup \\ \uparrow \quad \uparrow \\ \downarrow \quad \downarrow \\ \uparrow \quad \uparrow \\ k \quad l+r \end{array} \end{array} = \sum_{s=0}^{\min(k,l)} q^{-s(s+r)+\frac{(k-s)(l-s)}{n}} \begin{array}{c} l \quad k+r \\ \begin{array}{c} \uparrow \quad \uparrow \\ \diagdown \quad \diagup \\ \uparrow \quad \uparrow \\ \downarrow \quad \downarrow \\ \uparrow \quad \uparrow \\ s \quad l+r \end{array} \end{array} .$$

Using Lemma 5.7 (which is proved independently) for the $(k-s, l-s)$ braiding, we have that the right-hand side of the above relation is equal to

$$\begin{aligned}
& \sum_{s=0}^{\min(k,l)} q^{-s(s+r)} \sum_{t=0}^{\min(k,l)-s} (-q)^{-t} \text{Diagram} \\
& \stackrel{\text{Equation 5.3, Equation 5.4}}{=} \sum_{s=0}^{\min(k,l)} q^{-s(s+r)} \sum_{t=0}^{\min(k,l)-s} (-q)^{-t} \begin{bmatrix} s+t \\ s \end{bmatrix} \text{Diagram} \\
& \stackrel{\text{put } s+t=u}{=} \sum_{s=0}^{\min(k,l)} q^{-s(s+r)} \sum_{u=s}^{\min(k,l)} (-q)^{s-u} \begin{bmatrix} u \\ s \end{bmatrix} \text{Diagram} \\
& \stackrel{\text{square switch}}{=} \sum_{s=0}^{\min(k,l)} q^{-s(s+r)} \sum_{u=s}^{\min(k,l)} (-q)^{s-u} \begin{bmatrix} u \\ s \end{bmatrix} \sum_{t=u-s}^{\min(k,l)-s} \begin{bmatrix} u+r \\ t \end{bmatrix} \text{Diagram} \\
& \stackrel{\text{Equation 5.3, Equation 5.4}}{=} \sum_{s=0}^{\min(k,l)} q^{-s(s+r)} \sum_{u=s}^{\min(k,l)} (-q)^{s-u} \begin{bmatrix} u \\ s \end{bmatrix} \sum_{t=u-s}^{\min(k,l)-s} \begin{bmatrix} u+r \\ t \end{bmatrix} \begin{bmatrix} s+t \\ u \end{bmatrix} \text{Diagram}
\end{aligned}$$

$$\begin{aligned}
& \stackrel{\text{put } v=s+t}{=} \sum_{s=0}^{\min(k,l)} q^{-s(s+r)} \sum_{u=s}^{\min(k,l)} (-1)^{s+u} q^{s-u} \begin{bmatrix} u \\ s \end{bmatrix} \sum_{v=u}^{\min(k,l)} \begin{bmatrix} u+r \\ v-s \end{bmatrix} \begin{bmatrix} v \\ u \end{bmatrix} \begin{array}{c} l \quad k+r \\ \uparrow \quad \uparrow \\ \leftarrow \quad \rightarrow \\ \uparrow \quad \uparrow \\ k \quad l+r \end{array} \\
& = \sum_{s=0}^{\min(k,l)} \sum_{u=s}^{\min(k,l)} \sum_{v=u}^{\min(k,l)} (-1)^{s+u} q^{-s(s+r)} q^{s-u} \begin{bmatrix} u \\ s \end{bmatrix} \begin{bmatrix} u+r \\ v-s \end{bmatrix} \begin{bmatrix} v \\ u \end{bmatrix} \begin{array}{c} l \quad k+r \\ \uparrow \quad \uparrow \\ \leftarrow \quad \rightarrow \\ \uparrow \quad \uparrow \\ k \quad l+r \end{array} .
\end{aligned}$$

Switching the order of summations, while keeping in mind that $(-1)^{s+u} = (-1)^v (-1)^s (-1)^{u-v}$, the last sum is equal to

$$\sum_{v=0}^{\min(k,l)} (-1)^v \sum_{s=0}^v (-1)^s \sum_{u=s}^v (-1)^{u-v} q^{-s(s+r)+s-u} \begin{bmatrix} v \\ s \end{bmatrix} \begin{bmatrix} u+r \\ u-s, v-u \end{bmatrix} \begin{array}{c} l \quad k+r \\ \uparrow \quad \uparrow \\ \leftarrow \quad \rightarrow \\ \uparrow \quad \uparrow \\ k \quad l+r \end{array}$$

where we used the quantum trinomial coefficient. Further, ignoring the web, we write the last sum as

$$\sum_{v=0}^{\min(k,l)} (-1)^v \sum_{s=0}^v (-1)^s q^{vs-s} \begin{bmatrix} v \\ s \end{bmatrix} \sum_{u=s}^v (-1)^{u-v} q^{-s(s+r)+s-u-vs+s} \begin{bmatrix} u+r \\ u-s, v-u \end{bmatrix}$$

and from [Lat21, Lemma 3.1.5], this is equal to

$$\sum_{v=0}^{\min(k,l)} (-1)^v \delta_{v,0} \sum_{u=s}^v (-1)^{u-v} q^{-s(s+r+v-2)-u} \begin{bmatrix} u+r \\ u-s, v-u \end{bmatrix} .$$

This sum is nontrivial if and only if $v = 0$. In that case also $u = s = 0$ and

$$\sum_{u=s}^v (-1)^{u-v} q^{-s(s+r+v-2)-u} \begin{bmatrix} u+r \\ u-s, v-u \end{bmatrix} = 1,$$

meaning that the right-hand side of the initial relation is equal to

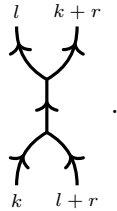

This finishes the proof that Equation 5.5 can be deduced from Equation 5.3, Equation 5.4 and thick square switches from Lemma 5.6. \square

We stress that Lemma 5.6 and Lemma 5.8 imply that the dumbbell-crossing and the thick square switch are equivalent relations in a certain sense. Let us also stress out that if the underlying field of $\mathbf{SWeb}_\uparrow^{\text{int}}(\mathfrak{gl}_n)$ would be $\mathbb{k}(q^{\frac{1}{n}})$ then we could use thinner merges and splits as generators. Then we would be able to define thick merges, splits and braidings via explosion of strings as in the previous sections. Combining this with Lemma 5.6 and Lemma 5.8 we have the following.

Corollary 5.9. *If we work over $\mathbb{k}(q^{\frac{1}{n}})$ (or any field where the quantum binomials are invertible), then $\mathbf{SWeb}_{\uparrow}^{\text{int}}(\mathfrak{gl}_n)$ is equivalent to $\mathbf{SWeb}_{\uparrow}(\mathfrak{gl}_n)$.*

While avoiding any scalar inversion, one can show that a lot of the web properties hold also integrally (See [Lat21, Section 6.2]). As a consequence we have the following.

Theorem 5.10. *There exists a full functor*

$$\Gamma_{\text{sym}}^{\text{int}} : \mathbf{SWeb}_{\uparrow, \downarrow}^{\text{int}}(\mathfrak{gl}_n) \rightarrow U_q(\mathfrak{gl}_n)\text{-fdMod}_{S, S^*}$$

defined similarly to Γ_{sym} .

REFERENCES

- [APW91] H.H. Andersen, P. Polo, and K.X. Wen. Representations of quantum algebras. *Invent. Math.*, 104(1):1–59, 1991.
- [AST18] H.H. Andersen, C. Stroppel, and D. Tubbenhauer. Cellular structures using U_q -tilting modules. *Pacific J. Math.*, 292(1):21–59, 2018.
- [BDK20] G.C. Brown, N.J. Davidson, and J.R. Kujawa. Quantum webs of type q . 2020.
- [BEAEO20] J. Brundan, I. Entova-Aizenbud, P. Etingof, and V. Ostrik. Semisimplification of the category of tilting modules for GL_n . *Adv. Math.*, 375:107331, 37, 2020.
- [BZ08] A. Berenstein and S. Zwicknagl. Braided symmetric and exterior algebras. *Trans. Amer. Math. Soc.*, 360(7):3429–3472, 2008.
- [CKM14] S. Cautis, J. Kamnitzer, and S. Morrison. Webs and quantum skew Howe duality. *Math. Ann.*, 360(1-2):351–390, 2014.
- [Eli15] B. Elias. Light ladders and clasp conjectures. 2015.
- [Kup96] G. Kuperberg. Spiders for rank 2 Lie algebras. *Comm. Math. Phys.*, 180(1):109–151, 1996.
- [Lat21] G. Latifi. Minimal and integral presentations of \mathfrak{gl}_n -web categories. *Ph.D. thesis*, 2021. Universität Zürich.
- [Lus10] G. Lusztig. *Introduction to quantum groups*. Modern Birkhäuser Classics. Birkhäuser/Springer, New York, 2010. Reprint of the 1994 edition.
- [RT16] D.E.V. Rose and D. Tubbenhauer. Symmetric webs, Jones–Wenzl recursions, and q -Howe duality. *Int. Math. Res. Not. IMRN*, (17):5249–5290, 2016.
- [RTW32] G. Rumer, E. Teller, and H. Weyl. Eine für die Valenztheorie geeignete Basis der binären Vektorinvarianten. *Nachrichten von der Ges. der Wiss. Zu Göttingen. Math.-Phys. Klasse*, pages 498–504, 1932. In German.
- [RW20] L.-H. Robert and E. Wagner. Symmetric Khovanov-Rozansky link homologies. *J. Éc. polytech. Math.*, 7:573–651, 2020.
- [ST19] A. Sartori and D. Tubbenhauer. Webs and q -Howe dualities in types **BCD**. *Trans. Amer. Math. Soc.*, 371(10):7387–7431, 2019.
- [Tur89] V.G. Turaev. The category of oriented tangles and its representations. *Funktsional. Anal. i Prilozhen.*, 23(3):93–94, 1989.
- [TVW17] D. Tubbenhauer, P. Vaz, and P. Wedrich. Super q -Howe duality and web categories. *Algebr. Geom. Topol.*, 17(6):3703–3749, 2017.

G.L.: UNIVERSITY OF ZURICH, MATHEMATICAL INSTITUTE, WINTERTHURERSTRASSE 190, 8057, ZÜRICH,, SWITZERLAND

Email address: genta.latifi@math.uzh.ch

D.T.: THE UNIVERSITY OF SYDNEY, SCHOOL OF MATHEMATICS AND STATISTICS F07, OFFICE CARSLAW 827, NSW 2006, AUSTRALIA, WWW.DTUBBENHAUER.COM

Email address: daniel.tubbenhauer@sydney.edu.au