

Addressable quantum gates

Pablo Arrighi ✉

Université Paris-Saclay, CNRS, LMF, 91190 Gif-sur-Yvette, France and IXXI, Lyon, France

Christopher Cedzich ✉

Quantum Technology Group, Heinrich Heine Universität Düsseldorf, Universitätsstr. 1, 40225 Düsseldorf, Germany

Marin Costes ✉

Université Paris-Saclay, CNRS, ENS Paris-Saclay, LMF, 91190, Gif-sur-Yvette, France

Ulysse Rémond ✉

Université Paris-Saclay, CNRS, ENS Paris-Saclay, LMF, 91190, Gif-sur-Yvette, France

Benoît Valiron ✉

Université Paris-Saclay, CNRS, Centrale Supélec, LMF, 91190 Gif-sur-Yvette, France

Abstract

We extend the circuit model of quantum computation so that the wiring between gates is soft-coded within registers inside the gates. The addresses in these registers can be manipulated and put into superpositions. This aims at capturing indefinite causal orders, as well as making their geometrical layout explicit. We show how to implement the quantum switch and the polarizing beam splitter within our model. One difficulty is that the names used as addresses should not matter beyond the wiring they describe, i.e. the evolution should commute with “renamings”. Yet, the evolution may act nontrivially on these names. Our main technical contribution is a full characterization of such “nameblind” matrices.

2012 ACM Subject Classification Theory of computation

Keywords and phrases timed quantum circuits, clocked quantum circuits, routed quantum circuits, causal boxes, quantum causal graph dynamics, quantum controllable quantum circuits, quantum superpositions of causal orders

Acknowledgements We thank Cyril Branciard and Michel Quercia for insightful discussions and Pascal Baßler for carefully reading the manuscript. This work was funded by the Deutsche Forschungsgemeinschaft (DFG, German Research Foundation) – 441423094 and the German Federal Ministry of Education and Research (BMBF) within the funding program “quantum technologies – from basic research to market” via the joint project MIQRO under the grant number 13N15522. This publication was made possible through the support of the ID# 61466 grant from the John Templeton Foundation, as part of the “The Quantum Information Structure of Spacetime (QISS)” Project (qiss.fr). The opinions expressed in this publication are those of the author(s) and do not necessarily reflect the views of the John Templeton Foundation.

1 Introduction

The standard paradigm for quantum computation is the coprocessor model. In this model, quantum evolution is controlled by a purely classical device—a conventional computer. Quantum computation is described as the list of elementary instructions—the quantum gates—sent to the coprocessor: the so-called quantum circuit. This representation has long been thought of as the only viable model of quantum computation, and it has been successful in realizing sizeable complexity gains on numerous useful algorithms. However, in the coprocessor model only the data is quantum. The control flow—the order in which the gates are to be applied—is classically determined and definite. In other words, the wiring between the gates is fixed. Albeit quantum, the data flows through the circuit in a definite manner, i.e. the flow of information is classical.

Quantum mechanics allows for more: In [7] it was argued that classically ordered gates are not the only possible paradigm by constructing a new elementary circuit: the so-called quantum switch behaves like a *quantum* test: given a qubit q and a single instance of gates U and V , the operation $\text{SWITCH}(q)(U)(V)$ realizes

$$\begin{aligned} |0\rangle_q \otimes |\psi\rangle &\mapsto |0\rangle_q \otimes (UV|\psi\rangle), \\ |1\rangle_q \otimes |\psi\rangle &\mapsto |1\rangle_q \otimes (VU|\psi\rangle). \end{aligned} \tag{1}$$

Adding the quantum switch to a circuit renders the orders of gates *indefinite* [14]: the order in which U and V are applied depends on the state of the “control” qubit q . Hence, adding SWITCH enables data *and* computation to be in superposition. Notably, the quantum switch is not realizable in the coprocessor model, when only one instance of U and V is available [7]. Yet, it was shown to be realizable in experiments [12, 18, 19]. Moreover, it allows for gains in both communication complexity [16] and algorithmic complexity compared to textbook circuits [1].

In the recent years, several attempts have been made to encompass indefinite causal orders within a consistent model of quantum computing. A considerable strand of works focuses on the compositionality of indefinite causal orders, via sums of diagrams in the process theory of quantum mechanics [22], or higher-order circuits [11] featuring type annotations for that specific-purpose, some for routing per subspace [20], other to enforce the time-ordering of packets [17]. In all these proposals the flow of information remains static, whereas we allow for quantum dynamic routing.

A more recent strand of works, that is closest to ours, works by distinguishing data qubits from external control qubits [21, 8]. The latter are used to encode the order in which gates are to be applied upon the former. Because the control qubits can be manipulated coherently and conditionally, the flow of information is both dynamical and quantum, i.e. “second-quantised” in the language of [8]. We differ with [21] in that we allow for vacuum states and the increased compositionality that follows. Moreover, we express the geometry not through external control qubits, but via address registers directly within locally separated gates which allows for a clearer geometrical layout.

This last point echoes one more strand of works, which focuses on distributed quantum computing. Whilst traditionally conceived on a classical geometry [13], the study of Quantum Causal Graph Dynamics (QCGD) in [3] bears the premises of a fully quantum distributed model of computation, where even the configuration of the network is allowed to be in superposition. This framework, however, is rather abstract and axiomatic. A model of computation should be constructive; this is the case of the hands-on, bottom up approach presented here.

We provide a concrete model of fully quantum distributed computation featuring composable, locally separated gates inducing dynamical superpositions of causal order. This model is obtained, not by extending textbook quantum circuits in an ad hoc manner, e.g. by adding quantum switches [1], polarizing beam-splitters [9, 4] or the like. Instead, we introduce a single new principle encompassing these constructs and hopefully more. The basic idea is that gates are not hardwired but that the wiring

is soft-coded: each gate contains a register storing addresses of the gates it targets. Those registers are quantum, hence target addresses can be superposed. Moreover, they can interact with data and be entangled with it. Thereby, addresses may be sent to other gates, which naturally leads to evolving superpositions of causal orders.

Our contributions are the following:

- A novel computational paradigm —called *addressable quantum circuits*— generalising textbook quantum circuits, so as to make the flow of information quantum (Sect. 2).
- Showing that this quantum flow of information allows for indefinite causal order. We demonstrate this below by encoding the quantum switch and the polarizing beam-splitter (Sect. 3).
- A restriction of the model so that the actual names used as addresses do not matter beyond the wiring they describe, i.e. ‘disallowing pointer arithmetic’ in the manner of Java...
- ...which led us to solve the following linear algebra question as a natural byproduct: say that a matrix acts on the Hilbert space spanned by $|abc\dots\rangle, |acb\dots\rangle, |bac\dots\rangle$ in a way that commutes with renaming a into b etc. What is this matrix allowed to do? Can it still create superpositions? We provide a full, constructive characterization of such “nameblind” matrices. Whilst strongly structured, they still admit non-trivial behaviours. It is our main technical contribution (Sect. 4).
- The compositionality of the model is formalized (Appendix D). The physicality of the model is discussed through detailed comparison with other frameworks (Appendix F).

Notations are summarized in Appendix G.

2 The model

Addressable Quantum Circuits (AQC) consist of *sectors* that abstract physical locations in the laboratory. Each sector is uniquely identified by an *address* taken in a finite set \mathcal{A} —see Def. 18. Several sectors can be grouped together to form *gates*, which determine the level of granularity at which “local” unitary *gate operators* are applied. These concepts are formally introduced in this section. To establish familiarity, we encode the usual Bell state creation circuit as an AQC. This requires four sectors with addresses $\mathcal{A} = \{1, 2, 3, 4\}$ —see Fig. 1a.

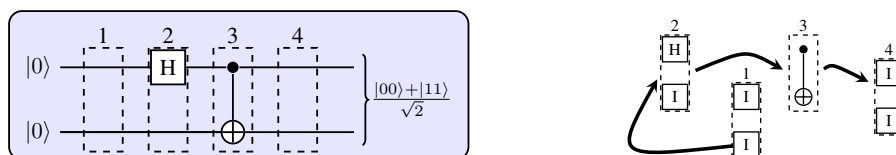

(a) Bell state creation as a textbook quantum circuit (b) Bell state creation as an addressable quantum circuit

■ **Figure 1** Dashed boxes represent sectors. (a) Textbook quantum circuits require a background layer that implies a time ordering, here shown explicitly in light purple. (b) The AQC formalism frees the information flow from the background surface. Each sector has a target space, holding a target address, as represented by the arrows. Addresses could have been taken in any other integer set instead.

2.1 Addresses and sectors

To each address we associate a sector, i.e. a connectable device which stores quantum data. The main novel feature of our formalism is its ability to manipulate and superpose addresses, and thus the connectivity between sectors. To this end, each sector has a *target address space* \mathcal{H}_T to determine where the output data is to be sent. Additionally, it can store other addresses in its *stored address spaces* \mathcal{H}_W . By locally acting on these spaces we may shuffle addresses, possibly into a superposition.

► **Definition 1** (Target address space, stored address space). Let the set of addresses \mathcal{A} be a finite set of integers. A target address space is a Hilbert space $\mathcal{H}_{\mathcal{T}}$, where $\mathcal{T} \equiv \{a | a \in \mathcal{A}^{\leq 1}\} = \mathcal{A}^?$ is the set of words on \mathcal{A} of length at most 1. In contrast, basis states of a stored address space $\mathcal{H}_{\mathcal{W}}$ can contain multiple addresses, but each address at most once. Thus, $\mathcal{H}_{\mathcal{W}}$ is a Hilbert space specified by $\mathcal{W} \equiv \{\bar{a} = a_1 \cdots a_n | a_i \in \mathcal{A}, a_i \neq a_j \forall i, j\} = \mathcal{A}^-$, the set of words on \mathcal{A} with all different letters.

► **Example 2.** With $\mathcal{A} = \{2, 3\}$, the vector $(|\varepsilon\rangle + |2\rangle + e^{-i\frac{\pi}{8}}|3\rangle + |3\ 2\rangle)/2$ is a valid state of $\mathcal{H}_{\mathcal{W}}$.

For the Bell state creation circuit, just like for any textbook quantum circuit encoding, the stored address spaces are unused and the target address spaces remain fixed. Specifying the target addresses for each sector makes the underlying background layer redundant: we might just as well dismantle the circuit as in Fig. 1b. In other examples with dynamically evolving wirings, the circuit may even be in a superposition of several arrow configurations —see e.g. Fig. 4b. Such superpositions of wirings induce superpositions of orders of applications of gates on the quantum data stored in $\mathcal{H}_{\mathcal{Q}}$:

► **Definition 3** (Data space). Let \mathcal{D} be a finite set of possible data values. The set of words on data of length at most n is denoted by $\mathcal{Q} = \mathcal{D}^{\leq n}$. Since \mathcal{D} is finite, so is \mathcal{Q} . The Hilbert space $\mathcal{H}_{\mathcal{Q}}$ is referred to as a data space.

Each sector contains two storage spaces: one for the input and one for the output, and both can store addresses and data. Each of these subspaces may be empty, in which case we denote its state by ε . Sectors with empty data spaces correspond to vacuum states [8].

► **Definition 4** (Input and output space, sector space). An input (resp. output) space is a Hilbert space $\mathcal{H}_{\mathcal{I}}$ (resp. $\mathcal{H}_{\mathcal{O}}$) of the form $\mathcal{H}_{\mathcal{W}} \otimes \mathcal{H}_{\mathcal{Q}}$. A sector space is a Hilbert space of the form $\mathcal{H}_{\mathcal{S}} = \mathcal{H}_{\mathcal{T}} \otimes \mathcal{H}_{\mathcal{I}} \otimes \mathcal{H}_{\mathcal{O}}$. To each address $a \in \mathcal{A}$ is associated a sector space $\mathcal{H}_{\mathcal{S}}^a$.

We write basis states of input (resp. output) spaces as $|\bar{a}, \bar{q}\rangle_{\mathcal{I}}$ (resp. $|\bar{a}, \bar{q}\rangle_{\mathcal{O}}$), where $\bar{a} \in \mathcal{W}$ and $\bar{q} \in \mathcal{Q}$. Basis states of a sector may be expressed as $|t\rangle_{\mathcal{T}} |\bar{a}\rangle_{\mathcal{I}} |\bar{q}\rangle_{\mathcal{I}} |\bar{a}'\rangle_{\mathcal{O}} |\bar{q}'\rangle_{\mathcal{O}} \in \mathcal{H}_{\mathcal{T}} \otimes \mathcal{H}_{\mathcal{W}_{\mathcal{I}}} \otimes \mathcal{H}_{\mathcal{Q}_{\mathcal{I}}} \otimes \mathcal{H}_{\mathcal{W}_{\mathcal{O}}} \otimes \mathcal{H}_{\mathcal{Q}_{\mathcal{O}}}$ or, by reordering the tensor factors as $|t\rangle_{\mathcal{T}} |\bar{a}\rangle_{\mathcal{I}} |\bar{a}'\rangle_{\mathcal{O}} |\bar{q}\rangle_{\mathcal{I}} |\bar{q}'\rangle_{\mathcal{O}} \in \mathcal{H}_{\mathcal{T}} \otimes \mathcal{H}_{\mathcal{W}_{\mathcal{I}}} \otimes \mathcal{H}_{\mathcal{W}_{\mathcal{O}}} \otimes \mathcal{H}_{\mathcal{Q}_{\mathcal{I}}} \otimes \mathcal{H}_{\mathcal{Q}_{\mathcal{O}}}$ —see Fig 2.

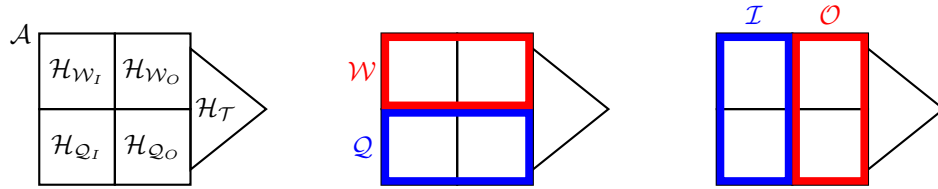

■ **Figure 2** (a) A sector. (b) Stored addresses vs. quantum data. (c) Input vs. output spaces.

When all **output** (resp. **input**) spaces are empty, we only represent the **input** (resp. **output**) spaces, as in Fig. 4b.

► **Example 5.** With $\mathcal{A} = \{1, 2, 3, 4\}$ as in Fig. 1a and $\mathcal{Q} = \{00, 01, 10, 11, \varepsilon\}$, the states $|\varepsilon, 10\rangle$, $|3, \varepsilon\rangle$ and $|23, 11\rangle$ are basis states for $\mathcal{H}_{\mathcal{I}}$ and $\mathcal{H}_{\mathcal{O}}$. E.g. $|\varepsilon, 11\rangle + |2, \varepsilon\rangle$ and $|2, 11\rangle$ are orthogonal. Moreover, $|3\rangle_{\mathcal{T}} |2, 01\rangle_{\mathcal{I}} |\varepsilon, \varepsilon\rangle_{\mathcal{O}}$ is a basis state of $\mathcal{H}_{\mathcal{S}}$.

The state of the quantum system at any point of its evolution is described by a sum of tensor products of states of each of its sectors. E.g. in the beginning of the execution of the Bell state creation circuit —see Fig. 1a, the quantum system is in the state $|\psi_0\rangle$:

$$\begin{aligned}
 |\psi_0\rangle = & |2\rangle_{\mathcal{T}}^1 \otimes |\varepsilon^a, 00^d\rangle_{\mathcal{I}}^1 \otimes |\varepsilon^a, \varepsilon^d\rangle_{\mathcal{O}}^1 & \text{(sector 1)} \\
 & \otimes |3\rangle_{\mathcal{T}}^2 \otimes |\varepsilon^a, \varepsilon^d\rangle_{\mathcal{I}}^2 \otimes |\varepsilon^a, \varepsilon^d\rangle_{\mathcal{O}}^2 & \text{(sector 2)} \\
 & \otimes |4\rangle_{\mathcal{T}}^3 \otimes |\varepsilon^a, \varepsilon^d\rangle_{\mathcal{I}}^3 \otimes |\varepsilon^a, \varepsilon^d\rangle_{\mathcal{O}}^3 & \text{(sector 3)} \\
 & \otimes |\varepsilon\rangle_{\mathcal{T}}^4 \otimes |\varepsilon^a, \varepsilon^d\rangle_{\mathcal{I}}^4 \otimes |\varepsilon^a, \varepsilon^d\rangle_{\mathcal{O}}^4 & \text{(sector 4)}
 \end{aligned} \tag{2}$$

2.2 Addressable Gates

A *gate* is composed of multiple sectors, and thus can receive information from and send information to multiple sources and destinations. This grouping of sectors into gates defines a notion of locality for the evolution: during a “scattering step” a gate acts upon its constituent sectors with a local unitary.

► **Definition 6** (Gates, Gate Operators). *A gate g is a (non-empty) subset of a set of addresses \mathcal{A} , and the set of gates \mathcal{G} forms a partition of \mathcal{A} . The gate space of a gate g consists of $|g|$ sectors and is given by $\mathcal{H}^g = \bigotimes_{a \in g} \mathcal{H}_S^a$. A gate operator on $g \in \mathcal{G}$ is a unitary $S^g : \mathcal{H}^g \rightarrow \mathcal{H}^g$ which preserves the addresses of the target and stored spaces, i.e. $\langle \bar{a}' \bar{q}' | S^g | \bar{a} \bar{q} \rangle \neq 0$ implies that \bar{a}' has the same letters as \bar{a} , where \bar{a} and \bar{a}' (resp. \bar{q}, \bar{q}') list all target and stored addresses (resp. all data) in sectors of g .*

In general, gates act as the identity on the empty state ε . The gate operators of the Bell state creation circuit are given by

$$S^{\{1\}} = F = S^{\{4\}}, \quad S^{\{2\}} = F((H \otimes I)_{\mathcal{I}} \otimes I_{\mathcal{O}}), \quad S^{\{3\}} = F(\text{CNOT}_{\mathcal{I}} \otimes I_{\mathcal{O}}), \quad (3)$$

where F swaps the input and output systems. Note that neither data nor addresses are manipulated in sectors 1 and 4, yet they are required to compose this AQC with other AQCs —see Sect. D.

The overall state space of an AQC is the tensor product of its sector spaces together with an additional global condition: to guarantee the reversibility of the transport step that will be defined below, we require that each address appears at most once.

► **Definition 7** (Skeleton, Addressable Quantum Circuit). *A skeleton K is a tuple $(\mathcal{A}, \mathcal{G}, \mathcal{Q}, S)$ where:*

- \mathcal{A} is the set of addresses,
- \mathcal{G} is the set of gates,
- \mathcal{Q} is the set of data —consisting of words on data of length at most n ,
- S is a function associating a gate operator S^g to each gate $g \in \mathcal{G}$.

This specifies the sector spaces as $\mathcal{H}_S = \mathcal{H}_{\mathcal{T}} \otimes \mathcal{H}_{\mathcal{W}} \otimes \mathcal{H}_{\mathcal{Q}} \otimes \mathcal{H}_{\mathcal{W}} \otimes \mathcal{H}_{\mathcal{O}}$.

The circuit Hilbert space \mathcal{H} is defined as $\bigotimes_{a \in \mathcal{A}} \mathcal{H}_S^a$ restricted to superpositions of basis states where addresses appear at most once. An Addressable Quantum Circuit is a tuple $(K, |\psi\rangle)$ that specifies both the dynamics and the current state, i.e. K is a skeleton and $|\psi\rangle$ is a state of \mathcal{H} .

For example, the skeleton of the Bell state creation circuit in Fig. 1b is specified by $\mathcal{A} = \{1, 2, 3, 4\}$, $\mathcal{G} = \{\{1\}, \{2\}, \{3\}, \{4\}\}$, \mathcal{Q} induced by $\mathcal{D} = \{0, 1\}$ and $n = 2$, and S as in (3). In Ex. 9 below we choose the initial state of (2). Reordering tensor factors as above, we obtain $|\psi_0\rangle = |2, 3, 4, \varepsilon\rangle_{\mathcal{T}} |00, \varepsilon, \varepsilon, \varepsilon\rangle_{\mathcal{I}} |\varepsilon, \varepsilon, \varepsilon, \varepsilon\rangle_{\mathcal{O}}$.

2.3 Evolution

The overall evolution alternates a scattering step during which the gate operators are applied to their respective gates, and a transport step that swaps the output space of each sector with the input space of the sector it targets. The evolution is unitary i.e. it does not involve measurements.

► **Definition 8** (Evolution). *An addressable quantum circuit $((\mathcal{A}, \mathcal{G}, \mathcal{Q}, S), |\psi\rangle)$ evolves in one time step into $((\mathcal{A}, \mathcal{G}, \mathcal{Q}, S), |\psi'\rangle)$, where $|\psi'\rangle = G |\psi\rangle$ with $G = TS$ and:*

Scattering S is the application of $\bigotimes_g S^g$, i.e. the gate operators S^g are applied simultaneously on their corresponding gate spaces.

Transport T is a permutation of basis states, extended linearly to \mathcal{H} . The permutation maps synchronously each triple of the form $|j\rangle_{\mathcal{T}}^i |\bar{x}\rangle_{\mathcal{O}}^i |\bar{y}\rangle_{\mathcal{I}}^j$ to $|j\rangle_{\mathcal{T}}^i |\bar{y}\rangle_{\mathcal{O}}^i |\bar{x}\rangle_{\mathcal{I}}^j$, leaving the rest unchanged. When Sector i targets Sector j , i 's output space is swapped with j 's input space —see Fig. 3.

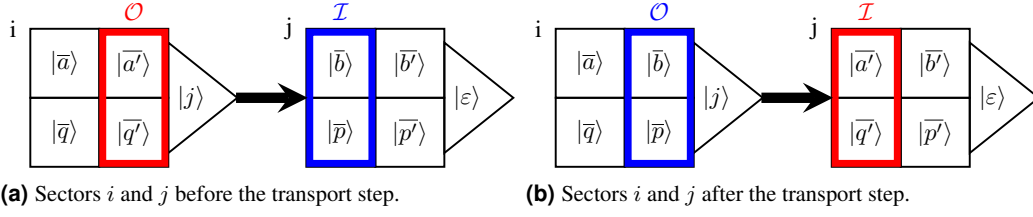

■ **Figure 3** Effect of the transport step upon two connected sectors —see example 19.

The purpose of the requirement that each address appears at most once becomes clear now: it is essential for the transport step to be well-defined, avoiding that a sector is targeted by more than one other sector.

► **Example 9.** Let us describe step-by-step the Bell state creation circuit of Fig. 1. We drop the stored address space which are always empty. In Ex. 20 we further break down the evolution into S and T . The blue and red terms (and, later, arrows —see Fig. 5) are superposed, and get entangled:

$$\begin{aligned}
& |2, 3, 4, \varepsilon\rangle_{\mathcal{T}} \otimes |00, \varepsilon, \varepsilon, \varepsilon\rangle_{\mathcal{I}} \otimes |\varepsilon, \varepsilon, \varepsilon, \varepsilon\rangle_{\mathcal{O}} \\
& \rightarrow_G |2, 3, 4, \varepsilon\rangle_{\mathcal{T}} \otimes |\varepsilon, 00, \varepsilon, \varepsilon\rangle_{\mathcal{I}} \otimes |\varepsilon, \varepsilon, \varepsilon, \varepsilon\rangle_{\mathcal{O}} \\
& \rightarrow_G |2, 3, 4, \varepsilon\rangle_{\mathcal{T}} \otimes \frac{1}{\sqrt{2}} (|\varepsilon, \varepsilon, 00, \varepsilon\rangle_{\mathcal{I}} + |\varepsilon, \varepsilon, 10, \varepsilon\rangle_{\mathcal{I}}) \otimes |\varepsilon, \varepsilon, \varepsilon, \varepsilon\rangle_{\mathcal{O}} \\
& \rightarrow_G |2, 3, 4, \varepsilon\rangle_{\mathcal{T}} \otimes \frac{1}{\sqrt{2}} (|\varepsilon, \varepsilon, \varepsilon, 00\rangle_{\mathcal{I}} + |\varepsilon, \varepsilon, \varepsilon, 11\rangle_{\mathcal{I}}) \otimes |\varepsilon, \varepsilon, \varepsilon, \varepsilon\rangle_{\mathcal{O}} \\
& \rightarrow_G |2, 3, 4, \varepsilon\rangle_{\mathcal{T}} \otimes |\varepsilon, \varepsilon, \varepsilon, \varepsilon\rangle_{\mathcal{I}} \otimes \frac{1}{\sqrt{2}} (|\varepsilon, \varepsilon, \varepsilon, 00\rangle_{\mathcal{O}} + |\varepsilon, \varepsilon, \varepsilon, 11\rangle_{\mathcal{O}}) \quad (*) \\
& \rightarrow_G |2, 3, 4, \varepsilon\rangle_{\mathcal{T}} \otimes |\varepsilon, \varepsilon, \varepsilon, \varepsilon\rangle_{\mathcal{I}} \otimes \frac{1}{\sqrt{2}} (|\varepsilon, \varepsilon, 00, \varepsilon\rangle_{\mathcal{O}} + |\varepsilon, \varepsilon, 11, \varepsilon\rangle_{\mathcal{O}}) \\
& \dots
\end{aligned}$$

The finite execution of usual circuits corresponds to a finite portion of the infinite evolution of AQC. In order to match the corresponding textbook circuit, this AQC needs to be stopped after step (*).

3 What can it do?

Using the Bell state creation circuit as a guiding example, we illustrated how textbook quantum circuits can be implemented in this framework. We argued that textbook quantum circuits only require hardwired one-sector gates in the sense that the connectivity of the graph is static and definite, i.e. $\mathcal{H}_{\mathcal{T}}$ is in a fixed basis state and $\mathcal{H}_{\mathcal{W}_I}$ and $\mathcal{H}_{\mathcal{W}_O}$ are empty.

As argued in the introduction, there exist physical devices that lie beyond the scope of hardwired circuits as they allow for superpositions of causal orders. We now describe how such superpositions naturally arise by superposing addresses in AQC.

3.1 The quantum switch

The quantum switch described in (1) applies unitaries U and V to m qubits in a superposition of causal orders that depends on a control qubit —see Fig. 4a. We can encode SWITCH as the AQC of Fig. 4b, where $\mathcal{A} = \{1, 2, 3, 4, 5, 6\}$, $\mathcal{G} = \{\{1\}, \{2, 5\}, \{3\}, \{4\}, \{6\}\}$, and $\mathcal{Q} = \{0, 1\}^{\leq m+1}$ contains m controlled qubits plus one control qubit. The gates $\{3\}$ and $\{4\}$ apply unitary operators U and V to the m controlled qubits, whereas the gate $\{2, 5\}$ implements the quantum switch itself.

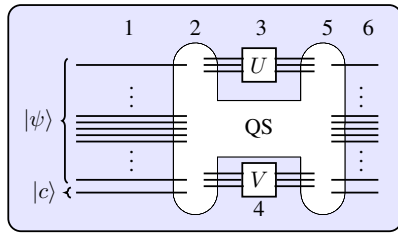

(a) Textbook-like representation of the Quantum Switch.

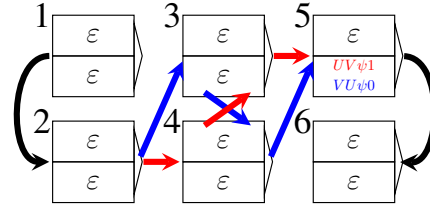

(b) AQC representation of the Quantum Switch during its execution. Red and blue data and targets are superposed.

■ **Figure 4** Superposing causal orders by superposing addresses.

As initial state we choose $|\psi_0\rangle = |2\rangle_{\mathcal{T}}^1 |\bar{q}c\rangle_{\mathcal{Q}_I}^1 |345\rangle_{\mathcal{W}_O}^2 |6\rangle_{\mathcal{T}}^5$, where $|c\rangle = \alpha|0\rangle + \beta|1\rangle \in \mathcal{H}_{\mathcal{D}}$ denotes the control qubit and $|\bar{q}\rangle$ are the m controlled qubits. All non specified spaces are empty, i.e. they are in state $|\varepsilon\rangle$.

Let us explain the behavior of this AQC. For the sake of brevity, when specifying scatterings by their action on basis states, non-represented spaces are understood to be empty, i.e. in state ε . Moreover, scatterings are understood to act as the identity on unspecified basis states. Sector 2 initially contains addresses 3, 4 and 5 as output stored addresses. When the data enters this sector, the gate operator $S^{\{2,5\}}$ superposes the addresses 3 or 4 in the target space (Fig. 5a) according to the control qubit, e.g. $|\varepsilon\rangle_{\mathcal{T}}^2 |345\rangle_{\mathcal{W}_O}^2 |\bar{q}c\rangle_{\mathcal{Q}_I}^2 \mapsto \alpha|3\rangle_{\mathcal{T}}^2 |45\rangle_{\mathcal{W}_O}^2 |\bar{q}0\rangle_{\mathcal{Q}_O}^2 + \beta|4\rangle_{\mathcal{T}}^2 |35\rangle_{\mathcal{W}_O}^2 |\bar{q}1\rangle_{\mathcal{Q}_O}^2$. It is then transported to sectors 3 (resp. 4) as shown in Fig. 5b. There, U (resp. V) is applied, and the target space of the respective sector is filled by the first address of the stored address space (Fig. 5c). The data continues its journey, and V (resp. U) is applied in sector 4 (resp. 3). The two branches meet in sector 5 (4b). The data halts here, while the target addresses fold back and the quantum switch reverts to its former, non entangled state. Then all data flow to sector 6. The mathematical details are found in Appendix A.2 and Fig. 9.

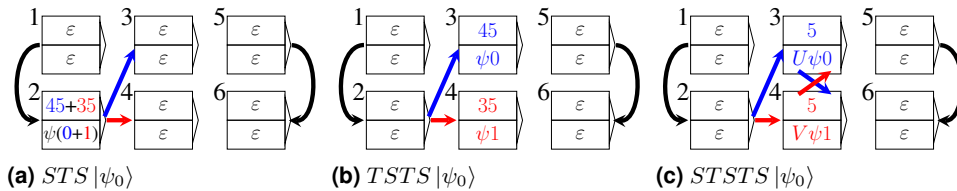

■ **Figure 5** Arrows represent the content of each target space. After the second scattering step we obtain the superposition $STS|\psi_0\rangle$ of the blue and red wirings in Fig.5a. Applying one more transport step yields 5b. The next scattering step yields 5c. Note that in 5a and 5c all input spaces are empty, such that only output spaces are described. Conversely, only input spaces are represented in 5b.

3.2 The polarizing beam-splitter

In a Polarizing Beam Splitter (PBS), birefringent material separates the incident beam according to its polarization —see Fig. 6a. They are used in the literature to implement indefinite causal orders [14, 9, 4], as in PBS the physical location of quantum data is itself quantum. Therefore, AQC's are well-suited to represent such devices, unlike textbook circuits which are ignorant towards locations.

Here, we consider a PBS where the horizontally polarized photons (H) pass through the bifringent material, while the vertically polarized ones (V) are reflected without phase shift. Photons as the physical carriers of data are represented by Fock states with a finite number of particles, and are further distinguished by their polarization. We represent this PBS as an AQC $((\mathcal{A}, \mathcal{G}, \mathcal{Q}, \mathcal{S}), |\psi_0\rangle)$, with

8 Addressable quantum gates

$\mathcal{D} = \{0_V, 1_V, \dots, m_V\} \times \{0_H, 1_H, \dots, m_H\}$ for some integer m being the total number of photons present in the circuit, $\mathcal{Q} = \mathcal{D}^{\leq 1}$, $\mathcal{A} = \{1, \dots, 8\}$, and $\mathcal{G} = \{\{1, 2, 3, 4\}, \{5\}, \{6\}, \{7\}, \{8\}\}$. The first gate $S^{\{1,2,3,4\}}$ corresponds to the PBS itself, as shown in Fig. 6a. Sectors 5 – 8 provide the context in which the the PBS is evolving and thus play the same role as the sectors 1 and 4 of the Bell state creation AQC and the sectors 1 and 6 in the SWITCH AQC. In this AQC, photons can enter the PBS from any direction. The gate operator $S^{\{1,2,3,4\}}$ makes them travel to the right sector depending on their polarization, as shown in Fig. 6a. They exit or enter the PBS during the transport step, as shown in Fig. 6b. We choose the initial state $|\psi_0\rangle = \bigotimes_{i=5}^8 |i-4\rangle_{\mathcal{T}} |i\rangle_{\mathcal{T}}^{i-4} |\psi_i\rangle_{\mathcal{Q}_T}$ where the $|\psi_i\rangle$ represent entry photons —see Fig. 6b, or a superposition of such $|\psi_0\rangle$. The content of the target spaces entails that each entry of the PBS may communicate only with the sector in front of it. The gate operator of the PBS gate $S^{\{1,2,3,4\}}$ acts on general states of the sectors 1 to 4 as

$$S^{\{1,2,3,4\}} : \bigotimes_{i=1}^4 |i+4\rangle_{\mathcal{T}} |n_i\rangle_V |m_i\rangle_H \mapsto \bigotimes_{i=1}^4 |i+4\rangle_{\mathcal{T}} |n_{v(i)}\rangle_V |m_{h(i)}\rangle_H, \quad (4)$$

where v (resp. h) is the function associating to a sector's vertical (resp. horizontal) polarization the sector indicated in Fig. 6a: $v(i) = i \bmod 2 + 1 + 2\lfloor i/2 \rfloor$ and $h(i) = (i+1) \bmod 4 + 1$.

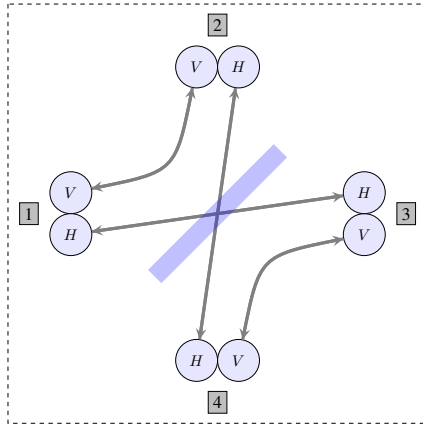

(a) Polarized Beam Splitter

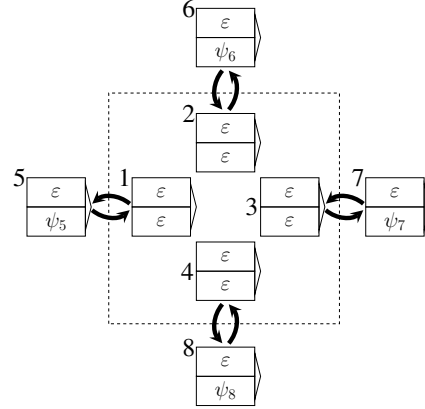

(b) The PBS AQC, represented with addresses around it

■ **Figure 6** H and V indicate dataspace corresponding to photons of horizontal (resp. vertical polarization). The dashed square represents the multi-sector PBS gate.

4 Renamings

So far, in our model a single arbitrarily chosen integer denotes both a sector and its address. This is somewhat unsatisfactory, since addresses should merely encode the underlying geometry, i.e. wirings of the gates, and not depend on the actual names of sectors.

A reasonable model should therefore use names, but separate the actual physical evolution from their concrete choices. A standard way to implement this independence is to require invariance under *renamings*, i.e. under permutations of addresses. We call a gate operator *renaming-invariant*, or *nameblind* if it commutes with all such permutations. For instance, after renaming $x \mapsto x + 100 \bmod |\mathcal{A}|$, the gate operator $S^{\{1\}}$ that was applied at location $\{1\}$ is applied at location $\{101 \bmod |\mathcal{A}|\}$. Thus, as renamings reshuffle “physical locations” and their associated gate operators, renaming-invariance is a global condition. In Sect. 4.1, after a detour via a larger Hilbert space in which physical locations and their addresses are explicitly separated, we deduce an equivalent but local condition on gate operators.

A practical advantage of working with nameblind gate operators is the reduced number of cases to be specified. For instance, a gate operator manipulating 6 addresses acts over $6! \times 7$ basis states of the address spaces if the target space is empty (ordering the six addresses and separating them amongst input and output) plus $6 \times 6!$ such basis states if the target space is occupied, which gives a total of 9360 —see Appendix A.1. If the gate operator is nameblind, it suffices to specify its behaviour on 13 basis states (fixing an order of the addresses and distributing them target, input and output) cases to specify it entirely. Renaming-invariance is thus a very restrictive condition, and one may wonder whether it leaves any room for superposing addresses at all. Surprisingly, it does. We will fully characterize the structure of nameblind gate operators in Sect. 4.2.

An instructive analogy to renaming invariance from daily life is that of postal delivery, where a letter has to be delivered to a certain house with some house number. This house number is fairly arbitrary and might change due to bureaucratic processes. To guarantee the success of the mailman, when that happens, one has to make that change consistently, i.e. also on the letter and even in the phone books. In other words, if only the house number changes, the letter won't arrive. Below, we further distinguish renamings into “internal” and “external” ones w.r.t. a gate. Such renamings can be thought of as changing the house number only in a particular street and everywhere except in that street, respectively.

We remark that the idea of invariance under renamings of pointers is standard in the realm of classical programming languages. For instance, it is standard to consider pointers (or references) as opaque in high-level programming languages such as Java, or OCaml. From a semantics perspective, one way to model such opaque names is to use nominal sets: a variable that is precisely invariant under renaming. Unlike for nominal sets, the set of names in the current setting is finite.

4.1 Named AQC

In the formalism of AQC we use addresses in two distinct ways, with two different notations. Take for instance the state of a single sector $|s\rangle^i = |t\rangle_{\mathcal{T}}^i |\bar{a}\rangle_{\mathcal{W}}^i |\bar{q}\rangle_{\mathcal{Q}}^i$. On the one hand, addresses are “physical locations”. This is denoted by the superscript i (think of it like a house). On the other hand, addresses are also used to target the flow of information. Those are the t (think of it like the address of another house on an envelope) and the \bar{a} (think of it like an address book from which the gate operator can choose). These are denoted as states of certain registers.

In order to discuss renamings in the AQC context, we need to carefully separate the two uses of addresses, and put them on an equal footing. We achieve this by extending the Hilbert space by a “name space” that is induced by $\mathcal{N} \equiv \mathcal{T}$. Letting $|t\rangle_{\mathcal{T}}^i |\bar{a}\rangle_{\mathcal{W}}^i |\bar{q}\rangle_{\mathcal{Q}}^i \mapsto |t\rangle_{\mathcal{T}}^i |\bar{a}\rangle_{\mathcal{W}}^i |\bar{q}\rangle_{\mathcal{Q}}^i |i\rangle_{\mathcal{N}}^i$ leads to the modified formalism which we refer to as *Named Addressable Quantum Circuit* (NAQC) —see B.1. In that larger space, when we rename addresses, we no longer need to modify the order in which the corresponding sectors occur. Renamings act locally upon each sector without shuffling them around:

$$R\left(\bigotimes_i |\bar{a}\bar{q}\rangle^i |i\rangle^i\right) = \bigotimes_i |R(\bar{a}\bar{q})\rangle^i |R(i)\rangle^i.$$

In other words, superscript i is the physical location (the house) at which a gate S^i will always be applied, before and after a renaming. $|R(i)\rangle^i$ is the name of the physical location (the number on the house). Any occurrence of $R(i)$ within some $|R(\bar{a}\bar{q})\rangle^j$ still points toward the same physical location (address of the house). The identification between AQC and NAQC thus extends to

$$|t\rangle_{\mathcal{T}}^i |\bar{a}\rangle_{\mathcal{W}}^i |\bar{q}\rangle_{\mathcal{Q}}^i \equiv_R |R(t)\rangle_{\mathcal{T}}^i |R(\bar{a})\rangle_{\mathcal{W}}^i |\bar{q}\rangle_{\mathcal{Q}}^i |R(i)\rangle_{\mathcal{N}}^i, \quad (5)$$

where the right side is to be read as an equivalence class w.r.t. R .

► **Definition 10** (Renaming and nameblind NAQC). A bijection over \mathcal{A} is called a **renaming**. It naturally extends pointwise to \mathcal{W} and \mathcal{T} , and linearly to $\mathcal{H}_{\mathcal{W}}$, $\mathcal{H}_{\mathcal{T}}$, and to any Hilbert space by acting non-trivially only on its address (and name) spaces. We call a renaming R **external** to a gate g if it acts trivially on g , i.e. if $a \in g \Rightarrow R(a) = a$, i.e. it only manipulates external addresses $a \in \mathcal{A} \setminus g$. Moreover, we call an NAQC $((\mathcal{A}, \mathcal{G}, \mathcal{Q}, S, \mathcal{N}), |\psi\rangle)$ **nameblind** if S commutes with every renaming R , i.e. if $RS = SR$.

Nameblindness can be tested locally on each gate by demanding that $\forall g \in \mathcal{G}, RS^g = S^gR$. This allows us to lift the notion of nameblindness back to AQCs:

► **Theorem 11** (Nameblind AQC). Nameblind NAQCs are isomorphic to AQCs $((\mathcal{A}, \mathcal{G}, \mathcal{Q}, S), |\psi\rangle)$ for which for all g in \mathcal{G} , and for all renamings E external to g , $S^gE = ES^g$. Such AQCs are therefore referred to as the **nameblind AQCs**.

Summarizing, an AQC is nameblind if its gate operators commute with all external renamings. Next, we show that such gate operators are made of blocks of ‘nameblind matrices’, i.e. matrices that commute with all renamings, and study the structure of these.

4.2 Nameblind matrices

Gate operators S of nameblind AQCs, called *nameblind* gate operators, manipulate all external addresses in the same manner, yet may do so in a non-trivial way. For instance, S may choose to swap one for the other, or not, in a superposition, as shown by the general form of nameblind unitary matrices over two addresses:

$$U_{\pm}(\varphi, \vartheta) = e^{i\varphi} \begin{pmatrix} \cos(\vartheta) & \pm i \sin(\vartheta) \\ \pm i \sin(\vartheta) & \cos(\vartheta) \end{pmatrix}.$$

understood as acting over $\text{Span}\{|a b\rangle, |b a\rangle\}$ with any $a, b \in \mathcal{A}$, $a \neq b$. Note that the data register of the gate space can readily be used to control these angles, e.g. we could let $S|\bar{a} \bar{x}\rangle = (U_{+}(\varphi_{\bar{x}}, \vartheta_{\bar{x}})|\bar{a}\rangle) \otimes |\bar{x}\rangle$:

► **Example 12.** The action of the SWITCH gate $S^{\{2,5\}}$ in the cases shown in Fig. 9c and Fig. 5a is described by $U_{+}(\varphi_{\bar{x}}, \vartheta_{\bar{x}})|\bar{a}\rangle$ with control angles: $\vartheta_{\bar{x}} = \varphi_{\bar{x}} = 0$ when the control qubit in \bar{x} is 0, and $\vartheta_{\bar{x}} = \varphi_{\bar{x}} = \frac{\pi}{2}$ when the control qubit in \bar{x} is 1, followed by a swap of input and output data spaces.

Keeping this in mind, we now turn our attention towards matrices over n addresses, which commute with all renamings. Such matrices act on the vector space whose *canonical basis* is identified with the words of length n on the alphabet $\{1 \dots n\}$, i.e. n addresses between 1 and n . Moreover, we sort this canonical basis in ascending lexicographic order, i.e. $\{12 \dots (n-1)n, 12 \dots n(n-1), \dots, n(n-1) \dots 21\}$.

► **Theorem 13** ((n, n) -nameblind matrices). Matrices on states containing all n addresses which commute with all renamings, i.e. (n, n) -nameblind matrices, are of the following form:

$$\begin{pmatrix} D & B & M_1 B & M_2 M_1 B & M_3 M_2 M_1 B & \dots \\ B & D & M_1 B M_1 & M_2 M_1 B M_1 & \dots & \\ B M_1 & M_1 B M_1 & D & & & \\ B M_1 M_2 & M_1 B M_1 M_2 & & \ddots & & \\ B M_1 M_2 M_3 & \vdots & & & & \\ \vdots & & & & & \end{pmatrix}$$

where the blocks act on $n-1$ addresses, D is any (n, n) -nameblind matrix, M_i is the renaming $i \leftrightarrow i+1$, and B (see Sect. C.3) commutes with M_i (see Sect. C.1) for each $i = 2, 3, \dots, n-2$.

By forcing the partially-nameblind matrix B to be nameblind, inductively so, one obtains a convenient subfamily of (n, n) -nameblind matrices, built from exactly two smaller matrices of the same subfamily. Even though they are of size $n! \times n!$, these have only $\mathcal{O}(2^n)$ degrees of freedom. This makes these matrices easy to construct in practice.

► **Corollary 14** (Pure nameblind matrices). *Any matrix of the form*

$$\begin{pmatrix} D & B & M_1 B & M_2 M_1 B & M_3 M_2 M_1 B & \dots \\ B & D & B & M_2 B & \dots & \\ M_1 B & B & D & & & \\ M_1 M_2 B & M_2 B & & \ddots & & \\ M_1 M_2 M_3 B & \vdots & & & & \\ \vdots & & & & & \end{pmatrix}$$

is nameblind, where D and B are pure nameblind matrices on $(n - 1)$ addresses and the M_i are as in Thm. 13.

Our main goal is to characterize gate operators, which do not necessarily act on the full address space of an AQC. As gate operators never create nor suppress addresses, we can consider separately all lengths of address words. For instance, with $\mathcal{A} = \{1, 2, 3\}$, we consider independently the action of a gate operator on words of length 2, i.e. on the subset $\{12, 21, 13, 31, 23, 32\}$.

Let M be a nameblind matrix acting on words in \mathcal{A}^- of size $m \leq n = |\mathcal{A}|$, meaning that M is a nameblind matrix on a set of external addresses, some of which may not be present in the basis state. Such matrices, which we additionally require to neither create nor suppress addresses are called a (m, n) -nameblind matrix. They are characterized as follows:

► **Proposition 15** ((m, n) -nameblind matrices). *Let M be a (m, n) -nameblind matrix. When sorting the basis first by which addresses are present and then by lexicographical order, M can be written as $\bigoplus_{\mathcal{A}' \subset_m \mathcal{A}} D$ where D is a $(m!)$ -dimensional (m, m) -nameblind matrix as in Thm. 13.*

4.3 Gate Operators of a nameblind AQC

In practice, gate operators do not manipulate basis states solely composed of addresses. Basis states also contain data, separators between $(\mathcal{T}, \mathcal{I}$ and $\mathcal{O})$ spaces and between the different sectors. Moreover, recall from Thm. 11 that the gate operators of a nameblind AQC need only commute with external renamings. Still, they can be organized as blocks of nameblind matrices acting on well-identified subspaces, as in Fig. 7, 8 and 12.

A nameblind gate operator S can be written using only blocks of the form given by Thm. 13:

- First, we decompose the large gate space into $|Q^{2|g|}|$ subspaces for each possible basis state of the dataspace. For each couple of basis states $(|q_0\rangle, |q_1\rangle) \in \mathcal{H}_{\mathbb{Q}^{2|g|}}^2$ we denote $S_{q_0 \rightarrow q_1}$ the block of S which maps states with data $|q_0\rangle$ to states with data $|q_1\rangle$.
- Then we regroup states according to their number of external addresses m and the set of internal addresses \mathcal{A}_{int} contained in their address spaces. Fig. 7 exemplifies the subspace defined by $\mathcal{A}_{int} = \{1\}$ and $m = 1$. Since both parameters are preserved by S and R , any $S_{q_0 \rightarrow q_1}$ is block-diagonal in this basis.
- By also fixing positions P_{int} and P_{ex} for internal and external addresses, we can define even smaller subspaces preserved by renamings (but not by S). The blocks corresponding to this subspaces are $(m, n - |g|)$ -nameblind matrices (Prop. 15) —see Appendix C.5. They are illustrated in Fig. 8b and correspond to the different subspaces described in Fig. 7.

$$\begin{aligned}
 &|\varepsilon\rangle_{\mathcal{T}}|1a\rangle_{\mathcal{I}}|\varepsilon\rangle_{\mathcal{O}}, \quad |\varepsilon\rangle_{\mathcal{T}}|a1\rangle_{\mathcal{I}}|\varepsilon\rangle_{\mathcal{O}}, \quad |\varepsilon\rangle_{\mathcal{T}}|a\rangle_{\mathcal{I}}|1\rangle_{\mathcal{O}}, \quad |\varepsilon\rangle_{\mathcal{T}}|1\rangle_{\mathcal{I}}|a\rangle_{\mathcal{O}}, \\
 &|\varepsilon\rangle_{\mathcal{T}}|\varepsilon\rangle_{\mathcal{I}}|1a\rangle_{\mathcal{O}}, \quad |\varepsilon\rangle_{\mathcal{T}}|\varepsilon\rangle_{\mathcal{I}}|a1\rangle_{\mathcal{O}}, \quad |1\rangle_{\mathcal{T}}|a\rangle_{\mathcal{I}}|\varepsilon\rangle_{\mathcal{O}}, \quad |1\rangle_{\mathcal{T}}|\varepsilon\rangle_{\mathcal{I}}|a\rangle_{\mathcal{O}}, \\
 &|a\rangle_{\mathcal{T}}|1\rangle_{\mathcal{I}}|\varepsilon\rangle_{\mathcal{O}}, \quad |a\rangle_{\mathcal{T}}|\varepsilon\rangle_{\mathcal{I}}|1\rangle_{\mathcal{O}}
 \end{aligned}$$

■ **Figure 7** Consider a gate operator $S^{\{1\}}$ acting over one external address a plus its own address. Its state space can be organized into the above ten ‘nameblind’ subspaces which should be interpreted as $V_1 = \text{Span}_{a \in \mathcal{A} \setminus \{1\}}\{|\varepsilon\rangle_{\mathcal{T}}|1a\rangle_{\mathcal{I}}|\varepsilon\rangle_{\mathcal{O}}\}$, $V_2 = \text{Span}_{a \in \mathcal{A} \setminus \{1\}}\{|\varepsilon\rangle_{\mathcal{T}}|a1\rangle_{\mathcal{I}}|\varepsilon\rangle_{\mathcal{O}}\}$, etc. Knowing in which of these subspaces V_i we are, a fully determines a basis state. That is, basis states can be identified with the tuple (V_i, a) . All states within one of such subspaces evolve in the same manner under the action of $S^{\{1\}}$. Therefore, it suffices to describe the action of the gate operator on a general state $|V_i\rangle$ to describe its action on all the true basis states $|V_i\rangle \otimes |a\rangle$.

- Finally we know that these $(m, n - |g|)$ -nameblind matrices are block diagonal over subspaces defined by a set of m external addresses (Prop. 15), and only contain the same (m, m) -nameblind matrix in each block (in Fig. 8, each block $A_{i,j}$ denotes such a matrix). Indeed, these operators act the same way whatever the names of external addresses are, because we made such addresses indistinguishable.

These results are proved in full detail in Appendix C.5 together with Prop. 16, which states formally that a gate operator can be decomposed into (k, k) -nameblind matrices for some k .

$$S_{q_0 \rightarrow q_1} = \left(\begin{array}{c|c|c|c} B_1 & 0 & \dots & 0 \\ \hline 0 & B_2 & \dots & 0 \\ \hline \vdots & \vdots & \ddots & \vdots \\ \hline 0 & 0 & \dots & B_{f(n,m)} \end{array} \right)$$

(a) Block $S_{q_0 \rightarrow q_1}$ of a gate operator

$$B_i = \left(\begin{array}{c|c|c|c} A_{1,1} & 0 & 0 & A_{1,2} & 0 & 0 & \dots & A_{1,N} & 0 & 0 \\ \hline 0 & \ddots & 0 & 0 & \ddots & 0 & \dots & 0 & \ddots & 0 \\ \hline 0 & 0 & A_{1,1} & 0 & 0 & A_{1,2} & \dots & 0 & 0 & A_{1,N} \\ \hline A_{2,1} & 0 & 0 & A_{2,2} & 0 & 0 & \dots & A_{2,N} & 0 & 0 \\ \hline 0 & \ddots & 0 & 0 & \ddots & 0 & \dots & 0 & \ddots & 0 \\ \hline 0 & 0 & A_{2,1} & 0 & 0 & A_{2,2} & \dots & 0 & 0 & A_{2,N} \\ \hline \vdots & & & \vdots & & & \ddots & & & \vdots \\ \hline A_{N,1} & 0 & 0 & A_{N,2} & 0 & 0 & \dots & A_{N,N} & 0 & 0 \\ \hline 0 & \ddots & 0 & 0 & \ddots & 0 & \dots & 0 & \ddots & 0 \\ \hline 0 & 0 & A_{N,1} & 0 & 0 & A_{N,2} & \dots & 0 & 0 & A_{N,N} \end{array} \right)$$

(b) Detailed representation of the blocks B_i of Fig. 8a. If B_i corresponds to subspaces with k external addresses, the $A_{i,j}$ are (k, k) -nameblind matrices.

■ **Figure 8** To each pair of values q_0, q_1 in the data space corresponds a block $S_{q_0 \rightarrow q_1}$ of the gate operator. This block $S_{q_0 \rightarrow q_1}$ may be divided into sub-blocks B_i acting on subspaces having a given set of internal addresses \mathcal{A}_{int} and a given number of external addresses m —see Fig. 8a. Non-diagonal sub-blocks are zero because gate operators preserve these parameters. The diagonal sub-blocks are divided into (m, n) -nameblind matrices on more addresses than the ones present—see Prop. 15 for details. Those (m, n) -nameblind matrices are then split into (m, m) -nameblind matrices, yielding Prop. 16.

► **Proposition 16** (Decomposition of gate operators into (m, m) -nameblind matrices). *Let S^g be a gate operator on a set of addresses \mathcal{A} . Suppose that it commutes with all renamings on external addresses. Consider any words on quantum data q_0 & q_1 , internal addresses $\mathcal{A}_{int} \subseteq g$ with positions P_{int_1} & P_{int_2} , external addresses $\mathcal{A}_{ex} \subseteq \mathcal{A} \setminus g$ with positions P_{ex_1} & P_{ex_2} . The action of S^g between states corresponding to these parameters $S^g_{\mathcal{A}_{int}, \mathcal{A}_{ex}, q_0 \rightarrow q_1, P_{int_1} \rightarrow P_{int_2}, P_{ex_1} \rightarrow P_{ex_2}}$, is a (m, m) -nameblind matrix, where $m = |\mathcal{A}_{ex}|$.*

► **Example 17.** In Sect. 3, all gate operators are nameblind. As an example, let us argue that the gate operator of the SWITCH $S^{\{2,5\}}$ from Sect. 3.1 commutes with any renaming over $\mathcal{A} =$

$\{1, 2, 3, 4, 5, 6\}$. $S^{\{2,5\}}$ is controlled by many inputs, therefore proving renaming-invariance in all cases specified in Appendix A.2 would be cumbersome. Instead, we focus on the first case - the one leading to Fig. 5a. It explains how states from $\mathcal{K} = \{|ta\bar{a}'\rangle_{\mathcal{W}_O}^2 |\bar{q}c\rangle_{\mathcal{Q}_I}^2 |b\rangle_{\mathcal{T}}^5 \in \mathcal{H}^{\{2,5\}}\}$ evolve:

$$S^{\{2,5\}} |ta\bar{a}'\rangle_{\mathcal{W}_O}^2 |\bar{q}c\rangle_{\mathcal{Q}_I}^2 |b\rangle_{\mathcal{T}}^5 = \begin{cases} |t\rangle_{\mathcal{T}}^2 |a\bar{a}', \bar{q}c\rangle_{\mathcal{O}}^2 |b\rangle_{\mathcal{T}}^5 & \text{if } c = 0 \\ |a\rangle_{\mathcal{T}}^2 |ta', \bar{q}c\rangle_{\mathcal{O}}^2 |b\rangle_{\mathcal{T}}^5 & \text{if } c = 1 \end{cases} \quad (6)$$

To see that this operator is nameblind, we consider an element of the form $|ta\bar{a}'\rangle_{\mathcal{W}_O}^2 |\bar{q}1\rangle_{\mathcal{Q}_I}^2 |b\rangle_{\mathcal{T}}^5$ in \mathcal{K} and a renaming R :

$$\begin{aligned} RS^{\{2,5\}} |ta\bar{a}'\rangle_{\mathcal{W}_O}^2 |\bar{q}1\rangle_{\mathcal{Q}_I}^2 |b\rangle_{\mathcal{T}}^5 &= |R(a)\rangle_{\mathcal{T}}^2 |R(t)R(\bar{a}'), \bar{q}c\rangle_{\mathcal{O}}^2 |R(b)\rangle_{\mathcal{T}}^5 \\ &= S^{\{2,5\}} |R(t)R(a)R(\bar{a}')\rangle_{\mathcal{W}_O}^2 |\bar{q}1\rangle_{\mathcal{Q}_I}^2 |R(b)\rangle_{\mathcal{T}}^5 \\ &= S^{\{2,5\}} R |ta\bar{a}'\rangle_{\mathcal{W}_O}^2 |\bar{q}1\rangle_{\mathcal{Q}_I}^2 |b\rangle_{\mathcal{T}}^5. \end{aligned}$$

Similar calculations for the other cases show the nameblindness of $S^{\{2,5\}}$.

5 Conclusion

Summary. We introduced Addressable Quantum Circuits (AQC), which consist of “gates” that are themselves divided into “sectors”. Each sector contains “data” and “addresses”. The evolution decomposes into two steps. During the ‘scattering step’, each gate applies a local unitary operator over the data and addresses of its constituent sectors. During the ‘transport step’, each sector holding an address within its ‘target space’, swaps the content of its ‘output space’ with that of the ‘input space’ of the target sector. We showed how indefinite causal orders and superpositions of paths emerge naturally in this formalism, by encoding the quantum switch and the polarizing beam-splitter. Operations that manipulate addresses raised the question of their fundamental nature. If we require addresses to represent purely geometrical data, we must restrict such operations by demanding that they are indistinguishable. Hence our focus on ‘nameblind’ AQCs, i.e. those whose scattering step commute with ‘renamings’ of addresses. Through a detour via the sub-formalism of Named AQC, we derived local conditions on the gates of AQCs for it to be nameblind. The gates must commute with renamings over ‘external addresses’, i.e. those addresses which do not pertain to the gate. We were able to give the general form of the (n, n) -‘nameblind matrices’ (i.e. acting only over lists of addresses and commuting with every renaming) first, and then show that gates are blockwise decomposable into these. In the appendices we studied composability, and encoding within Quantum Causal Graph Dynamics (QCGD).

Perspectives. The structure of nameblind matrices and gates might simplify even further if combined with the unitary condition, helping us reach a full characterization of the behaviour of nameblind AQCs. Further comparison with related models could also be fruitful. Are AQCs equivalent, in terms of their expressiveness, to quantum channels extended with vacuum states [8]? Could an expressive process language be devised that would encompass AQC, including their dynamical aspects [6]? We proved that each AQC can be simulated by a QCGD, but is the converse simulation always possible? This last question would help us establish a form of completeness of AQCs within in-principle physically realisable dynamics over quantum causal orders. Of course, we wonder whether new protocols in distributed quantum computing may be expressed within this richer yet concrete framework.

References

- 1 Mateus Araújo, Fabio Costa, and Časlav Brukner. Computational advantage from quantum-controlled ordering of gates. *Phys. Rev. Lett.*, 113:250402, 2014. [arXiv:1401.8127](#).
- 2 Pablo Arrighi, Marios Christodoulou, and Amélia Durbec. On quantum superpositions of graphs. *arXiv preprint arXiv:2010.13579*, 2020.
- 3 Pablo Arrighi and Simon Martiel. Quantum causal graph dynamics. *Phys. Rev. D*, 96(2):024026, 2017. [arXiv:1607.06700](#).
- 4 Cyril Branciard, Alexandre Clément, Mehdi Mhalla, and Simon Perdrix. Coherent control and distinguishability of quantum channels via PBS-diagrams, 2021. [arXiv:2103.02073](#).
- 5 Charles Bukowski. *Post office*. Black Sparrow Press, 1971.
- 6 Esteban Castro-Ruiz, Flaminia Giacomini, and Časlav Brukner. Dynamics of quantum causal structures. *Phys. Rev. X*, 8:011047, 2018. [arXiv:1710.03139](#).
- 7 Giulio Chiribella, Giacomo Mauro D’Ariano, Paolo Perinotti, and Benoit Valiron. Quantum computations without definite causal structure. *Phys. Rev. A*, 88(2):022318, 2013. [arXiv:0912.0195](#).
- 8 Giulio Chiribella and Hlér Kristjánsson. Quantum Shannon theory with superpositions of trajectories. *Phys. Rev. A*, 475, 2019. [arXiv:1812.05292](#).
- 9 Alexandre Clément and Simon Perdrix. PBS-Calculus: A Graphical Language for Coherent Control of Quantum Computations. In *45th International Symposium on Mathematical Foundations of Computer Science (MFCS 2020)*, volume 170 of *Leibniz International Proceedings in Informatics (LIPIcs)*, pages 24:1–24:14, Prague, Czech Republic, 2020. [arXiv:2002.09387](#).
- 10 Richard Cleve, Artur Ekert, and Chiara Macchiavello. Quantum algorithms revisited. In *P. R. Soc. London.*, pages 339–354, 1997. [arXiv:quant-ph/9708016](#).
- 11 Bob Coecke and Aleks Kissinger. *Picturing Quantum Processes: A First Course in Quantum Theory and Diagrammatic Reasoning*. Cambridge University Press, 2017.
- 12 Nicolai Friis, Vedran Dunjko, Wolfgang Dür, and Hans J. Briegel. Implementing quantum control for unknown subroutines. *Phys. Rev. A*, 89:030303, 2014. [arXiv:1401.8128](#).
- 13 Simon J. Gay and Rajagopal Nagarajan. Communicating quantum processes. In *Proceedings of the 32nd ACM SIGPLAN-SIGACT Symposium on Principles of Programming Languages, POPL ’05*, page 145–157, New York, NY, USA, 2005. Association for Computing Machinery. [arXiv:quant-ph/0409052](#).
- 14 Kaumudibikash Goswami, Christina Giarmatzi, Michael Kewming, Fabio Costa, Cyril Branciard, Jacqueline Romero, and Andrew G. White. Indefinite causal order in a quantum switch. *Phys. Rev. Lett.*, 121(9), 2018. [arXiv:1803.04302](#).
- 15 Robin Lorenz and Jonathan Barrett. Causal and compositional structure of unitary transformations. *Quantum*, 5:511, 2021. [arXiv:2001.07774](#).
- 16 Ognjan Oreshkov, Fabio Costa, and Časlav Brukner. Quantum correlations with no causal order. *Nat. Commun.*, 3:1092, 2012. [arXiv:1105.4464](#).
- 17 Christopher Portmann, Christian Matt, Ueli Maurer, Renato Renner, and Bjorn Tackmann. Causal boxes: Quantum information-processing systems closed under composition. *IEEE T. Inform. Theory*, 63(5):3277–3305, 2017. [arXiv:1512.02240](#).
- 18 Lorenzo M. Procopio, Amir Moqanaki, Mateus Araújo, Fabio Costa, Irati Alonso Calafell, Emma G. Dowd, Deny R. Hamel, Lee A. Rozema, Časlav Brukner, and Philip Walther. Experimental superposition of orders of quantum gates. *Nature Communications*, 6(1), 2015. [arXiv:1412.4006](#).
- 19 Márcio Taddei, Jaime Cariñe, Daniel Martínez, Tania García, Nayda Guerrero, Alastair Abbott, Mateus Araújo, Cyril Branciard, Esteban Gómez, Stephen Walborn, Leandro Aolita, and Gabriela Lima. Computational advantage from the quantum superposition of multiple temporal orders of photonic gates. *PRX Quantum*, 2:010320, 2021. [arXiv:2002.07817](#).
- 20 Augustin Vanrietvelde, Hlér Kristjánsson, and Jonathan Barrett. Routed quantum circuits. *Quantum*, 5:503, 2021. [arXiv:2011.08120](#).
- 21 Julian Wechs, Hippolyte Dourdent, Alastair A. Abbott, and Cyril Branciard. Quantum circuits with classical versus quantum control of causal order, 2021. [arXiv:2101.08796](#).
- 22 Matt Wilson and Giulio Chiribella. A diagrammatic approach to information transmission in generalised switches, 2020. [arXiv:2003.08224](#).

A Addressable Quantum Circuits

A.1 Details on the model

Several notions are introduced in this paper. For a summary of notations —see Sect. G. This section provides details on Sect. 2.

Addresses

In the core of the paper the stored address spaces and the target spaces were defined in words. More formally, we have

► **Definition 18 (Addresses).** *The set of addresses \mathcal{A} is a finite subset of \mathbb{N} . Moreover, we denote by $\mathcal{W} = \mathcal{A}^+ = \{a_1 \dots a_n \mid a_i \in \mathcal{A}, a_i \neq a_j \forall i, j\}$ the set of words of non-repeating addresses, and by $\mathcal{T} = \mathcal{A}^* = \{a \mid a \in \mathcal{A}^+\} \cup \{\varepsilon\}$ the set of words of length at most one.*

When n addresses are in a sector space, a gate operator can map them to any superposition of the $(2n + 1)n!$ different states :

- if the target space is empty, there are $n + 1$ possibilities for the number of addresses in the input space (the others are in the output space) and $n!$ different ways to order them.
- if the target space is non-empty, the $n - 1$ remaining addresses are to be distributed between input and output space: any number of addresses from 0 to $n - 1$ can be in the input space, and as above, there are $n!$ different ways to order them order.

When n addresses are in a sector space, and additionally the gate operator is *nameblind*, there are only $2n + 1$ different possibilities counted as above but up to reordering. It suffices to specify the behaviour of the gate operator on one of each of those $(2n + 1)$ possibilities, to have them specified on all the corresponding $n!$ reordered possibilities, by renaming invariance —see Fig. 7.

Flipping gates

To prepare the transport to a targeted sector, many gate operators push some of their content to the output spaces after manipulating it. This is achieved by flipping operations, which are in some sense necessary since gates whose scattering unitary is the identity I are merely as a “mirror”, i.e. they reflect incoming data. In the example of the Bell state creation circuit in (3) the input and output spaces are flipped by

$$F : |t\rangle_{\mathcal{T}} |\bar{a}, \bar{q}\rangle_{\mathcal{I}} |\bar{a}', \bar{q}'\rangle_{\mathcal{O}} \mapsto |t\rangle_{\mathcal{T}} |\bar{a}', \bar{q}'\rangle_{\mathcal{I}} |\bar{a}, \bar{q}\rangle_{\mathcal{O}} .$$

Other possibilities are flipping only the data spaces, i.e.

$$F_{\text{data}} : |t\rangle_{\mathcal{T}} |\bar{a}, \bar{q}\rangle_{\mathcal{I}} |\bar{a}', \bar{q}'\rangle_{\mathcal{O}} \mapsto |t\rangle_{\mathcal{T}} |\bar{a}, \bar{q}'\rangle_{\mathcal{I}} |\bar{a}', \bar{q}\rangle_{\mathcal{O}} ,$$

or more sophisticated flips that are conditioned on the state of the sector.

Evolution

Like in Def. 8, the example below uses the following convention on the states : $|x\rangle_z^y$ indicates that the space $z \in \{\mathcal{T}, \mathcal{I}, \mathcal{O}\}$ of the sector $y \in \mathcal{A}$ is in the state $|x\rangle$.

► **Example 19.** Effect of the transport step T with $\mathcal{A} = \{1, 2\}$:

Without basis reordering :

$$\begin{array}{l} |2\rangle_{\mathcal{T}}^1 |\varepsilon, q_1\rangle_{\mathcal{I}}^1 |\varepsilon, \varepsilon\rangle_{\mathcal{O}}^1 \\ |\varepsilon\rangle_{\mathcal{T}}^2 |1, q_2\rangle_{\mathcal{I}}^2 |\varepsilon, \varepsilon\rangle_{\mathcal{O}}^2 \end{array} \xrightarrow{T} \begin{array}{l} |2\rangle_{\mathcal{T}}^1 |\varepsilon, q_1\rangle_{\mathcal{I}}^1 |1, q_2\rangle_{\mathcal{O}}^1 \\ |\varepsilon\rangle_{\mathcal{T}}^2 |\varepsilon, \varepsilon\rangle_{\mathcal{I}}^2 |\varepsilon, \varepsilon\rangle_{\mathcal{O}}^2 \end{array}$$

With basis reordering of Sect. 2.1:

$$\begin{array}{l} |2, \varepsilon\rangle_{\mathcal{T}} |(\varepsilon, q_1), (1, q_2)\rangle_{\mathcal{I}} |(\varepsilon, \varepsilon), (\varepsilon, \varepsilon)\rangle_{\mathcal{O}} \\ \xrightarrow{T} |2, \varepsilon\rangle_{\mathcal{T}} |(\varepsilon, q_1), (\varepsilon, \varepsilon)\rangle_{\mathcal{I}} |(1, q_2), (\varepsilon, \varepsilon)\rangle_{\mathcal{O}} \end{array}$$

The address 1 and data q_2 were in the input space of the sector 2, and T transports them to the output space of sector 1, because sector 1 targeted sector 2.

► **Example 20.** The Bell state creation circuit evolves very simply — missing the obvious coefficient here and not writing target spaces (as they do not change) and empty spaces :

$$\begin{array}{l} |00\rangle_{\mathcal{I}}^1 \rightarrow_S |00\rangle_{\mathcal{O}}^1 \quad \rightarrow_T |00\rangle_{\mathcal{I}}^2 \quad \rightarrow_S (|0\rangle + |1\rangle) |0\rangle_{\mathcal{O}}^2 \rightarrow_T (|0\rangle + |1\rangle) |0\rangle_{\mathcal{I}}^3 \\ \rightarrow_S |00\rangle_{\mathcal{O}}^3 + |11\rangle_{\mathcal{O}}^3 \rightarrow_T |00\rangle_{\mathcal{I}}^4 + |11\rangle_{\mathcal{I}}^4 \rightarrow_S |00\rangle_{\mathcal{O}}^4 + |11\rangle_{\mathcal{O}}^4 \rightarrow_T |00\rangle_{\mathcal{O}}^4 + |11\rangle_{\mathcal{O}}^4, \end{array}$$

where the lack of a target address in sector 4 causes the data to stay there during the last transport step.

A.2 Details of the Quantum Switch

A.2.1 Definition

The description of the quantum switch in Sect. 3.1 can be completed by specifying some gate operators S^g . Their action on the addresses is as follows:

$$S^{\{1\}} = F = S^{\{6\}}, \quad S^{\{3\}} = M_{34} \cdot L_U, \quad S^{\{4\}} = M_{34} \cdot L_V.$$

Here, L_g applies the gate g to the first m bits of data, i.e. on all data except the control qubit, and

$$M_{34} = \left(\begin{array}{l} |t\rangle_{\mathcal{T}} |\bar{a}\rangle_{\mathcal{W}_O} |\bar{q}\rangle_{\mathcal{Q}_O} \longleftrightarrow |\varepsilon\rangle_{\mathcal{T}} |t\bar{a}\rangle_{\mathcal{W}_I} |\bar{q}\rangle_{\mathcal{Q}_I} \\ |t\rangle_{\mathcal{T}} |\varepsilon\rangle_{\mathcal{W}_O} |\bar{q}\rangle_{\mathcal{Q}_O} \longleftrightarrow |\varepsilon\rangle_{\mathcal{T}} |t\rangle_{\mathcal{W}_I} |\bar{q}\rangle_{\mathcal{Q}_I} \end{array} \right)$$

The gate operator $S^{\{2,5\}}$, the effect of which is detailed in A.2.2, acts as follows (where $a, b, t \in \mathcal{A}$, $\bar{a}' \in \mathcal{A}^-$, $c \in \mathcal{D}$, $\bar{q} \in \mathcal{D}^m$ and, as usual, states that are omitted correspond to ε):

$$S^{\{2,5\}} |ta\bar{a}'\rangle_{\mathcal{W}_O}^2 |\bar{q}c\rangle_{\mathcal{Q}_I}^2 |b\rangle_{\mathcal{T}}^5 = \begin{cases} |t\rangle_{\mathcal{T}}^2 |a\bar{a}', \bar{q}c\rangle_{\mathcal{O}}^2 |b\rangle_{\mathcal{T}}^5 & \text{if } c = 0 \\ |a\rangle_{\mathcal{T}}^2 |t\bar{a}', \bar{q}c\rangle_{\mathcal{O}}^2 |b\rangle_{\mathcal{T}}^5 & \text{if } c = 1 \end{cases} \quad (7)$$

$$S^{\{2,5\}} |b\rangle_{\mathcal{T}}^2 |t\rangle_{\mathcal{T}}^5 |\bar{q}c\rangle_{\mathcal{Q}_I}^5 = |b\rangle_{\mathcal{T}}^2 |t\rangle_{\mathcal{W}_O}^5 |c\rangle_{\mathcal{Q}_I}^5 |\bar{q}\rangle_{\mathcal{Q}_O}^5 \quad (8)$$

$$S^{\{2,5\}} |t\rangle_{\mathcal{T}}^2 |\bar{b}\bar{a}'\rangle_{\mathcal{W}_O}^2 |c\rangle_{\mathcal{Q}_O}^2 |a, \bar{q}\rangle_{\mathcal{O}}^5 = \begin{cases} |t\bar{b}\bar{a}'\rangle_{\mathcal{W}_O}^2 |a\rangle_{\mathcal{T}}^5 |\bar{q}c\rangle_{\mathcal{Q}_O}^5 & \text{if } c = 0 \\ |bt\bar{a}'\rangle_{\mathcal{W}_O}^2 |a\rangle_{\mathcal{T}}^5 |\bar{q}c\rangle_{\mathcal{Q}_O}^5 & \text{if } c = 1 \end{cases} \quad (9)$$

We ensure unitarity of $S^{\{2,5\}}$ by specifying a reciprocal version of the equations above:

■ reciprocal version of (7):
$$\begin{cases} S^{\{2,5\}} |t\rangle_{\mathcal{T}}^2 |a\bar{a}', \bar{q}0\rangle_{\mathcal{O}}^2 |b\rangle_{\mathcal{T}}^5 = |ta\bar{a}'\rangle_{\mathcal{W}_O}^2 |\bar{q}0\rangle_{\mathcal{Q}_I}^2 |b\rangle_{\mathcal{T}}^5 \\ S^{\{2,5\}} |a\rangle_{\mathcal{T}}^2 |t\bar{a}', \bar{q}1\rangle_{\mathcal{O}}^2 |b\rangle_{\mathcal{T}}^5 = |ta\bar{a}'\rangle_{\mathcal{W}_O}^2 |\bar{q}1\rangle_{\mathcal{Q}_I}^2 |b\rangle_{\mathcal{T}}^5 \end{cases}$$

- of (8): $S^{\{2,5\}} |b\rangle_{\mathcal{T}}^2 |t\rangle_{\mathcal{W}_O}^5 |c\rangle_{\mathcal{Q}_X}^5 |\bar{q}\rangle_{\mathcal{Q}_O}^5 |\varepsilon\rangle_{\mathcal{W}}^2 = |b\rangle_{\mathcal{T}}^2 |t\rangle_{\mathcal{T}}^5 |\bar{q}c\rangle_{\mathcal{Q}_X}^5 |\varepsilon\rangle_{\mathcal{W}}^2$
- and of (9): $\begin{cases} |tb\bar{a}'\rangle_{\mathcal{W}_O}^2 |a\rangle_{\mathcal{T}}^5 |\bar{q}0\rangle_{\mathcal{Q}_O}^5 = S^{\{2,5\}} |t\rangle_{\mathcal{T}}^2 |\bar{b}\bar{a}'\rangle_{\mathcal{W}_O}^2 |0\rangle_{\mathcal{Q}_O}^2 |a, \bar{q}\rangle_{\mathcal{O}}^5 \\ |bt\bar{a}'\rangle_{\mathcal{W}_O}^2 |a\rangle_{\mathcal{T}}^5 |\bar{q}1\rangle_{\mathcal{Q}_O}^5 = S^{\{2,5\}} |t\rangle_{\mathcal{T}}^2 |\bar{b}\bar{a}'\rangle_{\mathcal{W}_O}^2 |1\rangle_{\mathcal{Q}_O}^2 |a, \bar{q}\rangle_{\mathcal{O}}^5 \end{cases}$

These three reciprocal cases are not useful in usual executions of the quantum switch, where they have zero amplitude. On all other basis states, $S^{\{2,5\}}$ acts as the identity. This fully defines $S^{\{2,5\}}$.

A.2.2 Correctness

The evolution of the quantum switch is displayed in Fig. 9. Since the operator $S^{\{2,5\}}$ is the most interesting gate operator, let us describe its action in detail. In the scattering after step 2, it acts as in (7). In step 5, it acts as in (8), which allows the remaining data to wait in the output space of sector 5. Most importantly, the control qubit flows back into the circuit, allowing the addresses to return to their initial positions in steps 6-9. In step 8, they “merge” back together, according to (9). The data then flows out of sector 5 into the outgoing buffer sector 6, and can be processed further by concatenated AQCs (see Sect. D.3) as the quantum switch is not entangled with the data anymore —see e.g. 9j.

That is, at the end of Fig. 9, the data has been delivered, and the quantum switch has folded back into its initial configuration. In Step 9 the final state of the data space is $UV|\psi\rangle|1\rangle + VU|\psi\rangle|0\rangle$ (when omitting scalar coefficients). This matches the behaviour described in (1), which proves correctness.

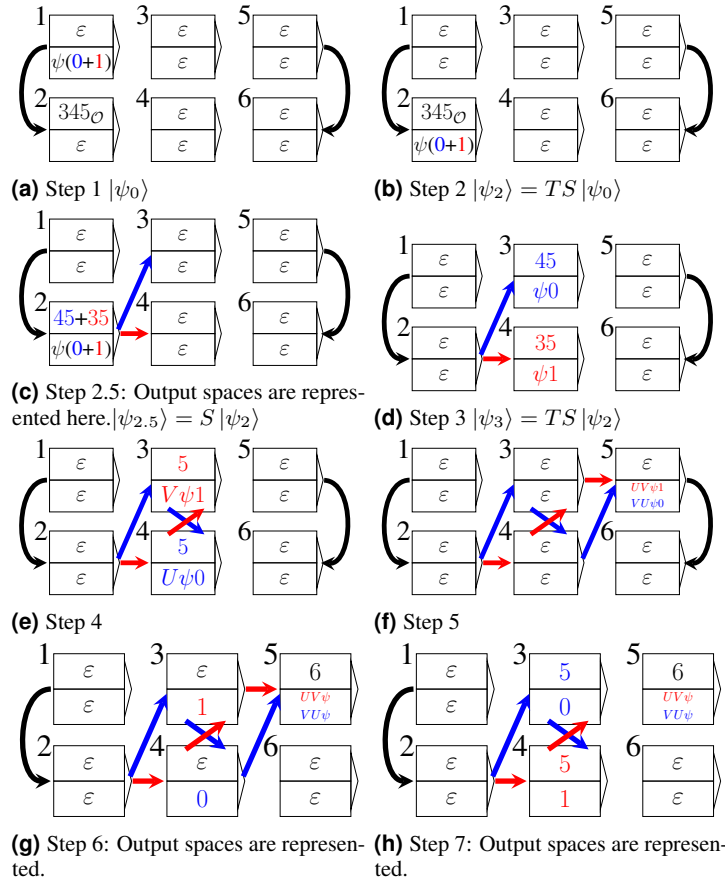

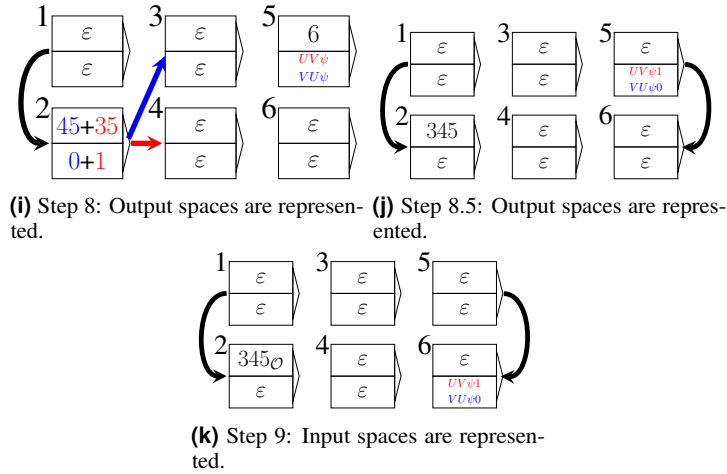

■ **Figure 9** One step corresponds to one application of the global evolution operator $G = TS$. In the initial step 1, the AQC is in its initial state $|\psi_0\rangle$. The step $n.5$ for any integer n corresponds to applying the operator S to the state of step n . The control qubit is $|c\rangle = \alpha|0\rangle + \beta|1\rangle$. Blue represents a scalar coefficient of α before the basis state, red represents a coefficient of β and black represents 1. When nothing is specified in caption, input spaces are represented, a \mathcal{O} in subscript (as in Figs. 9a, 9b, and 9k) indicates that this is in the output space.

As a final remark, note that according to Thm. 11 the nameblindness of $S^{\{2,5\}}$ only would have required commutation with renamings over the set of *external* addresses $\{1, 3, 4, 6\}$. Yet, we proved in Sect. 4.3 that it also holds for the addresses $\{2, 5\}$.

B Named AQC

To prove the results on the nameblindness of the main text, we disentangle the notions of physical locations and “names” as arbitrary labels of sectors. This amounts to extending the Hilbert spaces we work with by a “name space”, i.e. an additional address space, which allows us to carefully distinguish between instances of AQCs with differently chosen labelings. There are also other ways to describe a geometry than resorting to arbitrary names, e.g. working modulo isomorphism which, however, results in signalling problems [2].

B.1 Definition of an NAQC

Here we define formally every notion used for *Named AQC* (NAQC) which differs from that used for AQC.

► **Definition 21** (Named sector space). *Let i be the index of a sector. The Hilbert space $\hat{\mathcal{H}}^i = \mathcal{H}_{\mathcal{T}} \otimes \mathcal{H}_{\mathcal{I}} \otimes \mathcal{H}_{\mathcal{O}} \otimes \mathcal{H}_{\mathcal{N}}$ is referred to as a named sector space, with $\mathcal{H}_{\mathcal{N}}$ a copy of $\mathcal{H}_{\mathcal{A}}$ referred to as the name space.*

► **Definition 22** (Named circuit space). *The circuit space $\hat{\mathcal{H}}$ of an NAQC is the subspace of $\bigotimes_{i \in \mathcal{A}} \hat{\mathcal{H}}^i$ such that each address appears at most once in the combined target, input and output spaces, and exactly once in the name spaces.*

In the NAQC formalism, target spaces $\mathcal{H}_{\mathcal{T}}$ no longer target physical locations (a position as factor in the tensor product $\bigotimes_i \hat{\mathcal{H}}^i$). Instead, it targets the name $a \in \mathcal{A}$ of that physical location, as occurring in some name space $\mathcal{H}_{\mathcal{N}}$ of some sector. A gate $g = \{i_1, i_2, \dots, i_k\}$, on the other hand, consists of the sectors at the physical locations $\{i_1, i_2, \dots, i_k\}$.

► **Definition 23** (Named gate space). *The named gate space of a gate g consists of $|g|$ named sector spaces, i.e. it is given by $\hat{\mathcal{H}}^g = \bigotimes_{i \in g} \hat{\mathcal{H}}^i$.*

► **Definition 24** (Named gate operator). *A named gate operator on $g \in \mathcal{G}$ is a unitary $U : \hat{\mathcal{H}}^g \rightarrow \hat{\mathcal{H}}^g$ which preserves the addresses of the target and stored spaces as in Def. 6, and separately the name space stays unchanged.*

For any name $\mu \in \mathcal{A}^-$, we denote by $\hat{\mathcal{H}}_\mu^g := \mathcal{H}^g \otimes |\mu\rangle_{\mathcal{N}}$ the subspace of $\hat{\mathcal{H}}^g$ spanned by the basis states that give the name μ to the gate g . Clearly, $\hat{\mathcal{H}}^g$ is the smallest Hilbert space containing $\bigoplus_\mu \hat{\mathcal{H}}_\mu^g$. Moreover, since gate operators by definition preserve the name of the gate space, they are of the form $U^g = \bigoplus_\mu U_\mu^g$, i.e. named gate operators are block-diagonal with blocks U_μ^g acting on and preserving $\hat{\mathcal{H}}_\mu^g$.

► **Definition 25** (NAQC transport). *The named transport T maps synchronously $|a\rangle_{\mathcal{T}}^i |x\rangle_{\mathcal{O}}^i \otimes |y\rangle_{\mathcal{I}}^j |a\rangle_{\mathcal{N}}^j$ to $|a\rangle_{\mathcal{T}}^i |y\rangle_{\mathcal{O}}^i \otimes |x\rangle_{\mathcal{I}}^j |a\rangle_{\mathcal{N}}^j$, leaving the other sector constituents unchanged. That is, T swaps the output space of a sector with the input space of the sector with the name it targets, i.e. whenever a sector i targets a name a , i 's output space is swapped with the input space of the sector with name a .*

B.2 Renaming NAQCs

Let μ be a name, i.e. an element in \mathcal{A}^- . We call a renaming R , i.e. a permutation of \mathcal{A}^-

- **external** for μ , if R acts as the identity over each address in μ .
- **internal** for μ , if R acts as the identity over each address in $\mathcal{A} \setminus \mu$.
- **mixed** for μ , if R is a composition of disjoint swaps fully specified by two equal sized sets (M_1, M_2) where M_1 takes its elements in μ and M_2 takes its elements in $\mathcal{A} \setminus \mu$. R swaps the first element of M_1 for the natural order over \mathbb{N} with the first element of M_2 , the second with the second and so on). On elements of $\mathcal{A} \setminus (M_1 \cup M_2)$, R acts as the identity.

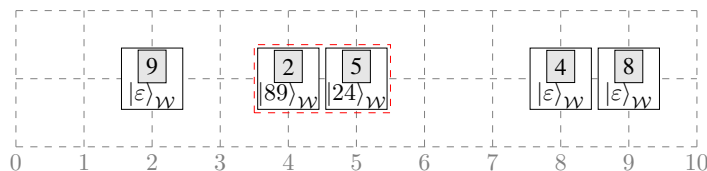

(a) An NAQC ...

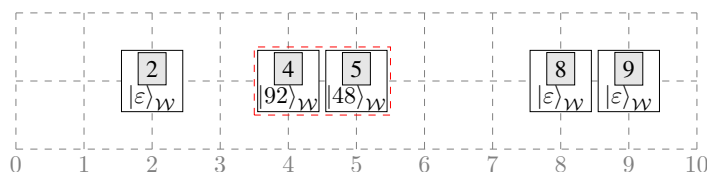

(b) ... renamed so that each gate space is named with the canonical name.

■ **Figure 10** An NAQC represented over a grid. Here $\mathcal{A} = \{2, 4, 5, 8, 9\}$. Inside of each sector (big white boxes) we can find the content of the stored address space. Gray boxes represent the content of the name space.

► **Example 26.** Consider the circuit in Fig. 10a. We focus here on the gate space $\{4,5\}$ which has the name 25. Then

- $R_{4 \leftrightarrow 8}$ is **external** because it only swaps external addresses.
- $R_{2 \leftrightarrow 5}$ is the only non trivial **internal** renaming for this state.

- $R_{5 \leftrightarrow 9, 2 \leftrightarrow 4}$ is **mixed** because it swaps external with internal addresses in an ordered fashion.
- $R_{5 \leftrightarrow 4, 2 \leftrightarrow 9}$ is neither internal nor mixed nor external.

Distinguishing these particular types of renamings is useful because any renaming R can be uniquely decomposed into a mixed, an internal and an external renaming with respect to a given name μ . The basic idea to construct this decomposition is to first apply a mixed renaming to bring all the letters of $R(\mu)$ into the gate space, then use an internal renaming to ensure that the gate space is named $R(\mu)$, and finally adjust the addresses that are not in μ with an external renaming. Let us define $R_{\mu \rightarrow \nu}$ the renaming changing the word μ to ν , and not changing other letters.

► **Proposition 27** (Decomposition of renamings).

- (1) Let μ and ν be names of same length. There is a unique renaming $R_{\mu \rightarrow \nu} = IM$ such that M is mixed for μ and I is internal for $M(\mu)$.
- (2) Let R be a renaming and μ be an element of \mathcal{A}^- —see Def. 18. There exists exactly one pair of renamings such that:

$$R = ER_{\mu \rightarrow \nu}$$

where $\nu = R(\mu)$ and E is external for ν .

Proof. For any name $\mu = \mu_1\mu_2 \dots \mu_k \in \mathcal{A}^-$ we write $\text{SET}(\mu) = \{\mu_1, \mu_2, \dots, \mu_k\}$ and note that it is invariant under renamings that are external and internal for μ .

- (1) Let $R : \mathcal{A} \rightarrow \mathcal{A}$ be a renaming, and take M as the renaming that swaps elements of

$$\text{SET}(\mu) \setminus \text{SET}(R(\mu))$$

with elements of

$$\text{SET}(R(\mu)) \setminus \text{SET}(\mu)$$

and is mixed for μ . Note that $\text{SET}(M(\mu)) = \text{SET}(R(\mu))$, and that M is unique since we have that $\text{SET}(M(\mu)) = \text{SET}(EIM(\mu))$. Similarly, take I as the renaming such that for every integer $0 < k < |\mu| + 1$

$$I : \mathcal{A} \rightarrow \mathcal{A}, \quad M(\mu)_k \mapsto R(\mu)_k,$$

and which is internal for $M(\mu)$. Since $IM(\mu) = EIM(\mu)$ for all E external for $IM(\mu)$, I is the only possible choice. Together, this gives a unique decomposition $R_{\mu \rightarrow \nu} = IM$.

(2) This follows from defining $E = RM^{-1}I^{-1}$ which is unique since it is the only renaming that guarantees $R = EIM$. Moreover, E is (trivially) external for $IM(\mu)$, since $EIM(\mu) = R(\mu) = IM(\mu)$, where the last equality is by construction of I in the proof of (1). ◀

► **Example 28.** Consider the renaming $R_{2 \rightarrow 9 \rightarrow 8, 4 \leftrightarrow 5}$ on the circuit of Fig. 10a, which maps the gate space state $|2\rangle_{\mathcal{N}} |89\rangle_{\mathcal{W}}^4 |5\rangle_{\mathcal{N}} |24\rangle_{\mathcal{W}}^5$ to $|9\rangle_{\mathcal{N}} |28\rangle_{\mathcal{W}}^4 |4\rangle_{\mathcal{N}} |95\rangle_{\mathcal{W}}^5$. We decompose it with respect to the name $\mu = 25$:

- Since $R(\mu) = 94$, the mixed renaming constructed in the above proof is $M = R_{5 \leftrightarrow 9, 2 \leftrightarrow 4}$, which results in the state $|4\rangle_{\mathcal{N}} |85\rangle_{\mathcal{W}}^4 |9\rangle_{\mathcal{N}} |42\rangle_{\mathcal{W}}^5$.
- Then, $I = R_{9 \leftrightarrow 4}$ is the only possible internal renaming that reorders the name of the gate space, which is thus in the state $|9\rangle_{\mathcal{N}} |85\rangle_{\mathcal{W}}^4 |4\rangle_{\mathcal{N}} |92\rangle_{\mathcal{W}}^5$.
- Finally, $E = R_{2 \rightarrow 5 \rightarrow 8}$ reorders the external addresses to match the desired ones.

Next, we relate AQC to NAQCs with specifically chosen gate names, called the canonical name —see Fig. 10b. To this end, consider a named gate space $\hat{\mathcal{H}}^g$ with $k = |g|$ sectors. Its basis states are of the form

$$\bigotimes_{\substack{i \in g \\ i \text{ increasing}}} |\bar{a}_i \bar{q}_i\rangle |\mu_i\rangle_{\mathcal{N}}^i$$

This state gives k names μ_i to the sectors inside the gate space, thus we say that this state gives the **name** $\mu = \mu_{i_1} \mu_{i_2} \dots \mu_{i_k}$ to the gate $g = i_1 i_2 \dots i_k$ with $i_1 < i_2 < \dots < i_k$.

► **Definition 29 (Canonical name).** Consider a gate $g = \{i_1, i_2, i_3, \dots, i_k\}$. The canonical name of g is $e = i_1 i_2 i_3 \dots i_k$ with $i_1 < i_2 < \dots < i_k$. The basis states of \mathcal{H}_e^g take the form:

$$\bigotimes_{i \in g} |\bar{a}_i \bar{q}_i\rangle |i\rangle^i$$

By this definition, the basis states of \mathcal{H}_e^g are in one-to-one correspondence with those of the gate space \mathcal{H}^g of an AQC (Sect. 2), i.e.

$$\bigotimes_{i \in g} |\bar{a}_i \bar{q}_i\rangle^i.$$

Choosing a canonical name means choosing a representative for each equivalence class w.r.t. renamings — see (5). Thus the subspace $\bigotimes_{i \in g} \mathcal{H}_{e(g)}^g$ of the named circuit space $\hat{\mathcal{H}}$ is isomorphic to the circuit space \mathcal{H} .

Finally, we describe those gate operators which act the same way whatever the name of the gate is. This reflects the idea that the action at a physical location (a house) should not depend on the arbitrary choice of name for that location (the number on the house), which is fiducial. Since such gate operators do not depend on the internal addresses in the name spaces of gate space, we call them “internally-blind”:

► **Definition 30 (Internally-blind gate operators).** Let g be a gate with k sectors and canonical name $e \in \mathcal{A}^-$. The named gate operator U^g is called **internally-blind** if for any $\mu \in \mathcal{A}^-$ with $|\mu| = k$ and for any state $|\phi\rangle \in \mathcal{H}_\mu^g$:

$$U_\mu^g |\phi\rangle = R_{e \rightarrow \mu} U_e^g R_{e \rightarrow \mu}^{-1} |\phi\rangle.$$

Internally-blind named gate operators are completely determined by their block U_e^g . In the next section we show that renaming-invariance imposes further constraints on this block.

B.3 Proof of Theorem 11

The concept of NAQC introduced above allows us to prove that nameblind AQCs and nameblind NAQCs are isomorphic. To do so, we show that nameblindness of an NAQC is equivalent to it being internally-blind, i.e. fully determined by its action over the canonical name (see Def. 30), and commuting with renamings that are external for the canonical name.

We show that internally-blind operators that commute with external renamings are nameblind:

► **Lemma 31 (Commutation with mixed and internal renamings).** Let U^g be an internally-blind gate operator, e the canonical name of g , and $\mu \in \mathcal{A}^-$ a name of size $|g|$. If U_e^g commutes with every renaming external to e , then for all $\nu \in \mathcal{A}^-$ with $|\nu| = |\mu|$ and any $|\phi\rangle \in \hat{\mathcal{H}}_\mu^g$

$$U^g R_{\mu \rightarrow \nu} |\phi\rangle = R_{\mu \rightarrow \nu} U^g |\phi\rangle.$$

Proof. Let $R_{\mu \rightarrow \nu}$ as in Prop. 27. Let E be the renaming defined by

$$E = R_{e \rightarrow \nu}^{-1} R_{\mu \rightarrow \nu} R_{e \rightarrow \mu}$$

Since $Ee = e$, it is external for e . We have:

$$\begin{aligned} U^g R_{\mu \rightarrow \nu} |\phi\rangle &= U_\nu^g R_{\mu \rightarrow \nu} |\phi\rangle && \text{(Diagonal blockwise)} \\ &= R_{e \rightarrow \nu} U_e^g R_{e \rightarrow \nu}^{-1} R_{\mu \rightarrow \nu} |\phi\rangle && \text{(Internally-blind)} \\ &= R_{e \rightarrow \nu} U_e^g E R_{e \rightarrow \mu}^{-1} |\phi\rangle && \text{(Definition of } E) \\ &= R_{e \rightarrow \nu} E U_e^g R_{e \rightarrow \mu}^{-1} |\phi\rangle && \text{(Hypothesis)} \\ &= R_{\mu \rightarrow \nu} R_{e \rightarrow \mu} U_e^g R_{e \rightarrow \mu}^{-1} |\phi\rangle && \text{(Definition of } E) \\ &= R_{\mu \rightarrow \nu} U_\mu^g |\phi\rangle && \text{(Internally-blind)} \\ &= R_{\mu \rightarrow \nu} U^g |\phi\rangle && \text{(Diagonal blockwise)} \end{aligned}$$

◀

► **Lemma 32** (Commutation with external renamings). *Let U^g be a internally-blind gate operator, e the canonical name of g , and $\mu \in \mathcal{A}^-$ a name of size $|g|$. If U_e^g commutes with every external renaming, then for all external renamings E and all $|\phi\rangle \in \hat{\mathcal{H}}_\mu^g$:*

$$U^g E |\phi\rangle = E U^g |\phi\rangle .$$

Proof. Let E be a renaming external for μ . Let E' be the renaming defined by:

$$E' = R_{e \rightarrow \mu}^{-1} E R_{e \rightarrow \mu}$$

E' is external for e so we have for each state $|\phi\rangle \in \mathcal{H}_\mu^g$:

$$\begin{aligned} U^g E |\phi\rangle &= U_\mu^g E |\phi\rangle \\ &= R_{e \rightarrow \mu} U_e^g R_{e \rightarrow \mu}^{-1} E |\phi\rangle && \text{(Internally-blind)} \\ &= R_{e \rightarrow \mu} U_e^g E' R_{e \rightarrow \mu}^{-1} |\phi\rangle && \text{(Definition of } E') \\ &= R_{e \rightarrow \mu} E' U_e^g R_{e \rightarrow \mu}^{-1} |\phi\rangle && \text{(Hypothesis)} \\ &= E R_{e \rightarrow \mu} U_e^g R_{e \rightarrow \mu}^{-1} |\phi\rangle \\ &= E U_\mu^g |\phi\rangle \end{aligned}$$

◀

► **Theorem 33** (Characterization of renaming invariance). *Let $\hat{\mathcal{H}}^g$ be a named gate space, U^g be a named gate operator and e the canonical name of g . U^g is renaming invariant if and only if U^g is internally-blind and U_e^g commutes with every renaming E external for e , i.e. $U_e^g E = E U_e^g$.*

Proof. $[\Rightarrow]$: Let U^g be a nameblind gate operator. Since by hypothesis U^g commutes with all renamings, it obviously commutes with the external ones, and so does the block U_e^g . To show that U^g is internally-blind, consider a renaming $R_{e \rightarrow \mu}$. Renaming invariance of U^g implies that $U^g R_{e \rightarrow \mu} = R_{e \rightarrow \mu} U^g$, and hence for every name μ of g and for each state $|\phi\rangle \in \hat{\mathcal{H}}_\mu$ we have

$$U_\mu^g |\phi\rangle = R_{e \rightarrow \mu} U_e^g R_{e \rightarrow \mu}^{-1} |\phi\rangle ,$$

which is a restatement of internal-blindness.

[\Leftarrow] : Let U^g be an internally-blind gate operator such that U_e^g commutes with all external renamings. Consider a renaming R and a name $\mu \in \mathcal{A}^-$ of size $|g|$. Then, for every state $|\phi\rangle \in \hat{\mathcal{H}}_\mu$:

$$\begin{aligned} U^g R |\phi\rangle &= U^g EIM |\phi\rangle && \text{(by Prop. 27)} \\ &= EU^g IM |\phi\rangle && \text{(by Lem. 32)} \\ &= EIMU^g |\phi\rangle && \text{(by Lem. 31)} \\ &= RU^g |\phi\rangle, \end{aligned}$$

i.e. U^g is renaming invariant. \blacktriangleleft

Thm. 33 states that the named gate operator U^g of a nameblind NAQC is fully characterized by its action U_e^g over the gates with canonical names, and that these must commute with external renamings. From Def. 29 it follows that the evolution of an NAQC over gates with canonical names is isomorphic to that of an AQC. Thus, the set of nameblind NAQCs is isomorphic to the set of AQCs whose gate operators commute with external renamings. Therefore, Thm. 11 follows from Thm. 33.

Proof of Thm. 11. Let us consider a nameblind NAQC $((\mathcal{A}, \mathcal{G}, \mathcal{Q}, S, \mathcal{N}), |\psi\rangle |e\rangle)$, its scattering S commutes with every renaming R , i.e. $RS = SR$. The isomorphic nameblind Addressable Quantum Circuit is $((\mathcal{A}, \mathcal{G}, \mathcal{Q}, U), |\psi\rangle)$, where U is defined as a scattering where each gate operator U^g is of the form $\bigoplus_{\mathcal{N}} U_e^g$ of Thm. 33. Reciprocally, given a nameblind AQC, as each gate operator S^g commutes with external renamings, $U^g = \bigoplus_{\mathcal{N}} S^g$ is a nameblind named gate operator that can be used to specify a nameblind NAQC. \blacktriangleleft

C Characterization of nameblind operators

Nameblind gate operators consist of blocks of nameblind matrices (see Prop. 16), which will be characterized inductively in this appendix. Below, when representing such operators over a list of n external addresses as matrices, we implicitly use the basis of words sorted in lexicographically ascending order, i.e.

$$\{12\dots(n-1)n, 12\dots n(n-1), \dots, n(n-1)\dots 21\}. \quad (10)$$

In this basis, the first $(n-1)!$ words begin with letter 1, the next $(n-1)!$ words begin with letter 2 etc. We often partition matrices acting on this $n!$ -dimensional Hilbert space into n^2 blocks, each acting between two $(n-1)!$ -dimensional Hilbert spaces, each being spanned by words starting with the same letter.

C.1 Adjacent transpositions

Let n be an integer and let us consider $k \in \{1, \dots, n-1\}$. We call the renaming R_k which swaps k and $k+1$ and acts as the identity otherwise an *adjacent transposition* on words of n addresses at k . Adjacent transpositions generate the group of renamings, such that any renaming can be written as a product of such adjacent transpositions. Commuting with all adjacent transpositions is therefore equivalent to commuting with all renamings.

Since every renaming can be written as a product of adjacent transpositions, commuting with all renamings is equivalent to commuting with all adjacent transpositions. Thus, A is nameblind iff $R_k A = A R_k$ for all $k \in \{1 \dots n-1\}$ with R_k as in (11), i.e. iff the following matrices are equal for every k :

$$R_k A = \begin{pmatrix} M_{k-1}A_{1,1} & M_{k-1}A_{1,2} & \dots & M_{k-1}A_{1,k} & M_{k-1}A_{1,k+1} & \dots & M_{k-1}A_{1,n} \\ M_{k-1}A_{2,1} & M_{k-1}A_{2,2} & \dots & M_{k-1}A_{2,k} & M_{k-1}A_{2,k+1} & \dots & \vdots \\ \vdots & \vdots & & \vdots & \vdots & & \vdots \\ A_{k+1,1} & A_{k+1,2} & \dots & A_{k+1,k} & A_{k+1,k+1} & \dots & A_{k+1,n} \\ A_{k,1} & A_{k,2} & \dots & A_{k,k} & A_{k,k+1} & \dots & A_{k,n} \\ \vdots & \vdots & & \vdots & \vdots & & \vdots \\ M_k A_{n,1} & \dots & \dots & M_k A_{n,k} & M_k A_{n,k+1} & \dots & M_k A_{n,n} \end{pmatrix}$$

$$A R_k = \begin{pmatrix} A_{1,1}M_{k-1} & A_{1,2}M_{k-1} & \dots & A_{1,k+1} & A_{1,k} & \dots & A_{1,n}M_k \\ A_{2,1}M_{k-1} & A_{2,2}M_{k-1} & \dots & A_{2,k+1} & A_{2,k} & \dots & \vdots \\ \vdots & \vdots & & \vdots & \vdots & & \vdots \\ A_{k,1}M_{k-1} & A_{k,2}M_{k-1} & \dots & A_{k,k+1} & A_{k,k} & \dots & A_{k,n}M_k \\ A_{k+1,1}M_{k-1} & A_{k+1,2}M_{k-1} & \dots & A_{k+1,k+1} & A_{k+1,k} & \dots & A_{k+1,n}M_k \\ \vdots & \vdots & & \vdots & \vdots & & \vdots \\ A_{n,1}M_{k-1} & \dots & \dots & A_{n,k+1} & A_{n,k} & \dots & A_{n,n}M_k \end{pmatrix}$$

This gives three types of conditions which we distinguish by their color in the matrices above:

Blue conditions

For each $i \in \{1, \dots, n-1\}$:

$A_{i,i} = A_{i+1,i+1}$, i.e. all diagonal blocks are equal.

$A_{i,i+1} = A_{i+1,i}$, i.e. the matrix is blockwise-symmetric near the diagonal.

We will henceforth write the diagonal blocks as $D := A_{1,1}$ and we set $B := A_{1,2}$.

Green conditions

Consider a row i , a column j and an adjacent transposition R_k . The green conditions from commutation with R_k are equivalent to:

Above the diagonal, i.e. $i < k < k+1 < j$:

- $A_{i,k+1} = M_{k-1}A_{i,k}$, i.e. one step to the right corresponds to right multiplication with M_{k-1} .
- $A_{k+1,j} = A_{k,j}M_k$, i.e. the $(k+1)$ -th element of column j is equal to M_k times the k -th element.

Below the diagonal, i.e. $j < k < k+1 < i$:

- $A_{i,k+1} = M_k A_{i,k}$, i.e. the $(k+1)$ -th element of line i is equal to M_k times the k -th element.
- $A_{k+1,j} = A_{k,j}M_{k-1}$, i.e. the $(k+1)$ -th element of column j is equal to M_{k-1} times the k -th element.

This has to hold for all k which gives the general form of A given in Thm. 13, because we can deduce all blocks from $A_{1,1}$ and $A_{1,2}$, but the conditions on the blocks are yet to be derived.

Black conditions

From the diagonal conditions in the top-left and bottom-right quadrant we immediately deduce that D commutes with all M_i for $0 < i < n - 1$, i.e. D is nameblind. Similarly, B commutes with all M_i for $2 < i < n - 1$. Thus, in the basis (10) A has the form (12).

Let us now show the converse, i.e. that any matrix A as specified in Thm. 13 is nameblind. By definition, it satisfies the blue and green conditions, and it only remains to check that it also meets the requirements of the black conditions. To this end, consider a block $A_{i,j}$ above the diagonal, i.e. $i < j$, which is symmetric with the case where it is below. By (12) this block is given by

$$A_{i,j} = M_{j-2} \dots M_1 B M_1 \dots M_{i-1}.$$

To satisfy the top-left and bottom-right conditions, this block has to commute with M_{k-1} for all k such that $j < k < n$, and with $M_{k'}$ for all k' such that $k' + 1 < i$, i.e. it has to commute with M_k for all $k \in K := \{1, \dots, i - 2\} \cup \{j, \dots, n - 2\}$. Explicitly, we need to show that for $k \in K$

$$M_{j-2} \dots M_1 B M_1 \dots M_{i-1} M_k = M_k M_{j-2} \dots M_1 B M_1 \dots M_{i-1}.$$

Rearranging this we obtain

$$\begin{aligned} B &= M_1 \dots M_{j-2} M_k M_{j-2} \dots M_1 B M_1 \dots M_{i-1} M_k M_{i-1} \dots M_1 \\ \Leftrightarrow B &= M_1 \dots M_{j-2} M_k M_{j-2} \dots M_1 M_1 \dots M_{i-1} M_k M_{i-1} \dots M_1 B \\ \Leftrightarrow B &= M_1 \dots M_{j-2} M_k M_{j-2} \dots M_i M_k M_{i-1} \dots M_1 B \\ \Leftrightarrow B &= M_1 \dots M_{j-2} M_k M_k M_{j-2} \dots M_i M_{i-1} \dots M_1 B \\ \Leftrightarrow B &= M_1 \dots M_{i-1} M_{i-1} \dots M_1 B \end{aligned}$$

where the first equivalence comes from premise that B commutes with renamings that preserves the letter 1 which $M_1 \dots M_{i-1} M_k M_{i-1} \dots M_1$ does since k is different from i and $i - 1$, and the third comes from the fact that two transpositions with disjoint support commute. Moreover, since $M_j M_j = I$ the right side of the last equation indeed gives B .

To verify the top-right and bottom-left conditions, consider a block $A_{i,j}$ with $i < j$, and a $i < k < j - 1$. Since the conditions for this quadrant are symmetric, this is sufficient. This block has to satisfy $A_{i,j} M_k = M_{k-1} A_{i,j}$. We calculate:

$$\begin{aligned} A_{i,j} M_k &= M_{j-2} \dots M_1 B M_1 \dots M_{i-1} M_k & (1) \\ &= M_{j-2} \dots M_1 B M_k M_1 \dots M_{i-1} & (2) \\ &= M_{j-2} \dots M_{k+1} M_k M_{k-1} M_k M_{k-2} \dots M_1 B M_1 \dots M_{i-1} & (3) \\ &= M_{j-2} \dots M_{k+1} M_{k-1} M_k M_{k-1} M_{k-2} \dots M_1 B M_1 \dots M_{i-1} & (4) \\ &= M_{k-1} M_{j-2} \dots M_{k+1} M_k M_{k-1} M_{k-2} \dots M_1 B M_1 \dots M_{i-1} & (5) \\ &= M_{k-1} A_{i,j} & (6) \end{aligned}$$

where as above we used that transpositions with disjoint support commute and that $B M_k = M_k B$ since $k > 1$. The non-trivial step in the fourth equality is to realize that $M_{k-1} M_k M_{k-1} = M_k M_{k-1} M_k = (k - 1 \quad k + 1)$.

Thus, all black conditions are satisfied by the blocks of A of the general form given in Thm. 13, which implies that A indeed is nameblind. \blacktriangleleft

C.3 Partially-nameblind operators

The matrix B of Thm. 13 is ‘‘partially-nameblind’’ in the sense that it commutes with all renamings which preserve the p first addresses in lexicographical order. We denote the set of such matrices by \mathcal{B}_p^n , where n indicates the total number of addresses.

► **Proposition 35** (Characterization of partially-nameblind matrices). *partially-nameblind matrices* $A \in \mathcal{B}_p^n$ are exactly those matrices which can be written as $A =$

$$\left(\begin{array}{ccccccccc} A_{1,1} & \dots & A_{1,p} & B_1^l & M_p B_1^l & M_{p+1} M_p B_1^l & \dots & & \\ A_{2,1} & \dots & A_{2,p} & B_2^l & M_p B_2^l & M_{p+1} M_p B_2^l & \dots & & \\ \vdots & & \ddots & & \vdots & & & & \\ A_{p,1} & \dots & A_{p,p} & B_p^l & M_p B_p^l & M_{p+1} M_p B_p^l & \dots & & \\ B_1^c & \dots & B_p^c & D & B & M_{p+1} B & \dots & & \\ B_1^c M_p & \dots & B_p^c M_p & B & D & M_{p+1} B M_{p+1} & \dots & & \\ B_1^c M_p M_{p+1} & \dots & B_p^c M_p M_{p+1} & B M_{p+1} & M_{p+1} B M_{p+1} & D & & & \\ \vdots & & & B M_{p+1} M_{p+2} & \vdots & & & \ddots & \\ & & & \vdots & & & & & \ddots \end{array} \right)$$

where $A_{i,j} \in \mathcal{B}_{p-1}^{n-1}$, B_i^l, B_i^c and D are in \mathcal{B}_p^{n-1} , and B is in \mathcal{B}_{p+1}^{n-1} .

Proof. As above, we use blue, green and top-left black conditions, which for matrices in \mathcal{B}_p^n however have to be satisfied only for $p < k$.

Conversely, we have to check that matrices of this form satisfy the black conditions. First, we consider blocks $A_{i,j}$ in the top-left or bottom-right corner. If $i < p + 1$ and $j < p + 1$ we just have to check that $A_{i,j}$ is in \mathcal{B}_{p-1}^{n-1} , which is the case by definition.

If $i > p$ and $j > p$, the proof of Thm. 13 applies. Thus, we only have to consider the case $i < p + 1, j > p$ since as the other one follows by symmetry. In this case the block is given as

$$A_{i,j} = M_{j-2} \dots M_p B_i^l,$$

and we have to verify that it commutes with M_{k-1} for all k such that $j < k < n$, and with $M_{k'}$ for all k' such that $p + 1 < k' + 1 < i$, i.e. that it commutes with M_k for each $k \in \{j, n - 2\}$ as $\{p + 1, \dots, i - 2\}$ is empty. Since these transpositions have disjointed support, this is straightforward to see.

Next, pick $A_{i,j}$ in the top-right or bottom-left corner. Since the top-right and bottom-left conditions are symmetric it is sufficient to consider the case $i < j$. Moreover, if $i > p$ again the previous proof applies, so we only consider $i < p + 1 < p + 2 < j$. We have to show that $A_{i,j} M_k = M_{k-1} A_{i,j}$ for all $k < j - 1$. Indeed,

$$\begin{aligned} A_{i,j} M_k &= M_{j-2} \dots M_p B_i^l M_k \\ &= M_{j-2} \dots M_k M_{k-1} M_k \dots M_p B_i^l \\ &= M_{j-2} \dots M_{k-1} M_k M_{k-1} \dots M_p B_i^l \\ &= M_{k-1} M_{j-2} \dots M_k M_{k-1} \dots M_p B_i^l \\ &= M_{k-1} A_{i,j} \end{aligned}$$

This ends the proof that all black conditions are satisfied by matrices of the general form given in Prop. 35, and thus we have proved the desired equivalence. ◀

C.4 (m, n)-nameblind matrices

C.4.1 Proof of Prop. 15

Consider a (m, n) -nameblind matrix M ; $n = |\mathcal{A}_{ex}|$ is the number of external addresses, and $m \leq n$ is the number of addresses present in any state handled by M . M is an operator over words on

m addresses chosen among n . In the following, we will use the basis of such words, not sorted in lexicographic ascending order as in $\{12\dots(m-1)m, 12\dots(m-1)(m+1), \dots, n\dots(n-m+2)(n-m), n\dots(n-m+2)(n-m+1)\}$, but instead sorted first by what addresses are present, and then by lexicographical ascending order, i.e.

$$\{12\dots(m-1)m, 12\dots m(m-1), \dots, n\dots(n-m+1)(n-m+2), n\dots(n-m+2)(n-m+1)\}.$$

Note that if $m < n$, M acts on basis states with less addresses than all external addresses. Let us show that M can be written blockwise with (m, m) -nameblind matrices (see Thm. 13).

This state space is partitioned according to the set \mathcal{A}' (of size m) of what addresses are actually present, each subspace being called $\hat{\mathcal{H}}_{\mathcal{A}'}$ — for some $\mathcal{A}' \subset \mathcal{A}_{ex}$. As M does neither create nor suppress addresses, it is also block diagonal (in the particular ordering we chose). Lemma 36 proves that all these blocks are equal.

Next, we show that all blocks are nameblind. To this end, consider a set of addresses \mathcal{B} with corresponding block $M_{\mathcal{B}}$ which maps words from $\hat{\mathcal{H}}_{\mathcal{B}}$ to $\hat{\mathcal{H}}_{\mathcal{B}}$, where $\hat{\mathcal{H}}_{\mathcal{B}}$ is the corresponding subspace. Then, for any renaming R manipulating addresses within $\hat{\mathcal{H}}_{\mathcal{B}}$, and any $w \in \hat{\mathcal{H}}_{\mathcal{B}}$:

$$RMw = RM_{\mathcal{B}}w, \quad MRw = M_{\mathcal{B}}Rw,$$

as $Rw \in \hat{\mathcal{H}}_{\mathcal{B}}$. The left sides of these equalities agree since M is nameblind. Therefore, $M_{\mathcal{B}}$ is nameblind, and as it is acting on words of size m on m addresses, it is (m, m) -nameblind.

C.4.2 Lemma - Block equality

The basis states of a (m, n) -nameblind matrix M are ordered according to which addresses \mathcal{A}' are present. For the sake of simplicity of demonstrating Lem. 36, we further specify the order between such address sets. Let \mathcal{A}' be a subset of \mathcal{A}_{ex} of size m . We define its *size* as the integer corresponding to the indicator function (understood as little-endian binary number), and note it $\mathfrak{B}(\mathcal{A}')$. For instance, with $\mathcal{A}_{ex} = \{1, 2, \dots, 6\}$:

$$\mathfrak{B}(\{2, 3, 4\}) = \text{Int}(011100) = 2^1 + 2^2 + 2^3 = 14$$

$$\mathfrak{B}(\{1, 2, 5\}) = \text{Int}(110010) = 2^0 + 2^1 + 2^4 = 17$$

Note that only the binary numbers with m bits set to 1 will be represented. The order between finite address sets is then simply the usual order between their sizes.

$\dots < 011100\rangle \leftrightarrow \{2, 3, 4\}$ $< 110010\rangle \leftrightarrow \{1, 2, 5\}$ $< 101010\rangle \leftrightarrow \{1, 3, 5\}$ $< 011010\rangle \leftrightarrow \{2, 3, 5\}$ $< 100110\rangle \leftrightarrow \{1, 4, 5\}$ $< 010110\rangle \leftrightarrow \{2, 4, 5\}$ $< 001110\rangle \leftrightarrow \{3, 4, 5\}$ $< 110001\rangle \leftrightarrow \{1, 2, 6\}$ $< \dots$	$\dots < 011100\rangle$ $ 011100\rangle < 110010\rangle$ — <i>Carry</i> $ 110010\rangle < 101010\rangle$ — <i>Incrementation</i> $ 101010\rangle < 011010\rangle$ $ 011010\rangle < 100110\rangle$ $ 100110\rangle < 010110\rangle$ $ 010110\rangle < 001110\rangle$ $ 001110\rangle < 110001\rangle$ $ 110001\rangle < \dots$
---	--

(a) Writing address sets as binary numbers to determine (b) Effect of the renaming : when is each case used. their size.

■ **Figure 11** Order and types of successive basis blocks, by writing the image of \mathcal{A} by the Indicator function of \mathcal{A}_i as a binary number. The pattern identified by $\mathcal{B}_{i,i+1}$ or $\mathcal{B}'_{i,i+1}$ is then represented as colored numbers.

► **Lemma 36.** *Let g be a gate of an AQC with address space \mathcal{A} . Write S^g in the basis sorted by:*

1. *First, according to the size of address sets —see above.*
 2. *Second, for each group of addresses, the words are sorted in lexicographical increasing order.*
- Then S is blockwise diagonal with blocks corresponding to which addresses are present, and each of those blocks are equal.*

Proof. Consider the set of external addresses $\mathcal{A}_{ex} = \{x_1, \dots, x_{n-|g|}\} \subset \mathcal{A}$ of the gate operator S^g , and two successive sets of addresses $\mathcal{A}_i = \{y_1 \dots y_p\} \subseteq \mathcal{A}_{ex}$ and $\mathcal{A}_{i+1} = \{y'_1 \dots y'_p\} \subseteq \mathcal{A}_{ex}$ (both ordered as specified in the lemma and as seen in Fig. 11). Then, extract the smallest continuous varying parts $\mathcal{B}_{i,i+1} = \{y_l, y_{l+1}, \dots, y_{l+m}\}$ and $\mathcal{B}'_{i,i+1} = \{y'_l, \dots, y'_{l+m}\}$ — also ordered the same way. Note that if $y_l = x_j$:

$$\begin{cases} \mathcal{B}_{i,i+1} = \{x_j, x_{j+1}, \dots, x_{j+m}\} \\ y'_{l+m} = x_{j+m+1} \end{cases}$$

We define now a renaming R so that $\forall k, R(y_{l+k}) = y'_{l+k}$. As a consequence, R always results in a identity block in the block column corresponding to the first state and in the line of the second state —as this renaming preserves the relative order of such words on addresses.

The renaming R is defined with the following case distinction:

- **Incrementation** If $\mathcal{B}_{i,i+1}$ is of the form $\{x_j\}$, then $\mathcal{B}'_{i,i+1}$ is $\{x_{j+1}\}$. R is defined as the transposition swapping x_j and x_{j+1} .
- **Carry** Else, $l = 1$. Then $\mathcal{B}_{i,i+1} = \{y_l = x_j, x_{j+1}, x_{j+2}, \dots, x_{j+m-1}, x_{j+m}\}$ consists of m successive numbers in \mathcal{A}_{ex} with $m > 0$, and $\mathcal{B}'_{i,i+1} = \{y'_1 = x_1, x_2, \dots, x_{m-1}, x_{j+m+1} = y'_{l+m}\}$. Therefore, R is defined as :
 1. $\forall k \in \{1, \dots, j-1\}, R(x_k) = x_{k+m}$
 2. $\forall k \in \{j, \dots, j+m-1\}, R(x_k) = x_{k-j+1}$
 3. $R(y_{l+m}) = R(x_{j+m}) = x_{j+m+1} = y'_{l+m}, R(y'_{l+m}) = x_{j+m}$
 4. $R(a) = a$ for any other $a \in \mathcal{A}$

The property $\forall k, R(y_{l+k}) = y'_{l+k}$ entails that $R\Pi_i = \Pi_{i+1}$, therefore : $\Pi_{i+1}RS\Pi_i = S_i$ and $\Pi_{i+1}SR\Pi_i = S_{i+1}$. As $RS = SR$ we have $S_i = S_{i+1}$. ◀

C.5 From gate operators to (n, n) -nameblind matrices

$$\begin{aligned} |\varepsilon\rangle_{\mathcal{T}} |abc\rangle_{\mathcal{I}} |\varepsilon\rangle_{\mathcal{O}}, \quad |\varepsilon\rangle_{\mathcal{T}} |ab\rangle_{\mathcal{I}} |c\rangle_{\mathcal{O}}, \quad |\varepsilon\rangle_{\mathcal{T}} |a\rangle_{\mathcal{I}} |bc\rangle_{\mathcal{O}}, \quad |\varepsilon\rangle_{\mathcal{T}} |\varepsilon\rangle_{\mathcal{I}} |abc\rangle_{\mathcal{O}}, \\ |a\rangle_{\mathcal{T}} |bc\rangle_{\mathcal{I}} |\varepsilon\rangle_{\mathcal{O}}, \quad |a\rangle_{\mathcal{T}} |b\rangle_{\mathcal{I}} |c\rangle_{\mathcal{O}}, \quad |a\rangle_{\mathcal{T}} |\varepsilon\rangle_{\mathcal{I}} |bc\rangle_{\mathcal{O}}. \end{aligned}$$

■ **Figure 12** The 7 subspaces with 3 external addresses of a one sector gate. a, b , and c represent a position of an address, spanned by any possible external address like in Fig. 7. Each one of the 49 blocks delimited by these subspaces contains a nameblind matrix.

► **Proposition 16** (Decomposition of gate operators into (m, m) -nameblind matrices). *Consider S^g a gate operator on addresses \mathcal{A} which commutes with every external renaming. Consider any words on quantum data q_0 & q_1 , internal addresses $\mathcal{A}_{int} \subseteq g$ with positions P_{int_1} & P_{int_2} , external addresses $\mathcal{A}_{ex} \subseteq \mathcal{A} \setminus g$ with positions P_{ex_1} & P_{ex_2} . The action of S^g between states corresponding to these parameters $S^g_{\mathcal{A}_{int}, \mathcal{A}_{ex}, q_0 \rightarrow q_1, P_{int_1} \rightarrow P_{int_2}, P_{ex_1} \rightarrow P_{ex_2}}$ is a (m, m) -nameblind matrix with $m = |\mathcal{A}_{ex}|$.*

Proof. Let g be a gate and $S = S^g$ a nameblind gate operator. First we decompose the large gate space \mathcal{H}^g into $|\mathcal{Q}^{2|g|}|$ subspaces for each possible basis state of the dataspace. For each couple of basis states $|q_0\rangle, |q_1\rangle \in \mathcal{H}_{\mathcal{Q}^{2|g|}}$ we denote by $S_{q_0 \rightarrow q_1}$ the block of S which maps states with data $|q_0\rangle$ to states with data $|q_1\rangle$. Since S is nameblind we have

$$\Pi_{q_1} S R |\bar{a}\rangle |q_0\rangle = S_{q_0 \rightarrow q_1} R |\bar{a}\rangle |q_0\rangle.$$

On the other hand:

$$\begin{aligned} \Pi_{q_1} S R |\bar{a}\rangle |q_0\rangle &= \Pi_{q_1} R S |\bar{a}\rangle |q_0\rangle \\ &= R S_{q_0 \rightarrow q_1} |\bar{a}\rangle |q_0\rangle \end{aligned}$$

where Π_{q_1} is the projector onto the subspace with data state q_1 . These equalities imply that each block must commute with renamings.

Furthermore, each $S_{q_0 \rightarrow q_1}$ is block diagonal over subspaces B_i defined by a number of external addresses $m \in \{0, \dots, |\mathcal{A} \setminus g|\}$ and a set of internal addresses $\mathcal{A}_{int} \subseteq g$, because both parameters are preserved by S . We cannot derive constraints between those diagonal blocks, since the subspaces B_i are preserved by renamings and gate operators.

Then, we further divide the B_i subspaces into subspaces characterized by a fixed position for each internal addresses of \mathcal{A}_{int} , and m "slots" for external addresses. We enumerate these subspaces (see Figs. 7 and 12) and denote them by $\overline{\mathcal{H}}_i$. Moreover, we write $S_{[i,j]} = \Pi_j S_{\overline{\mathcal{H}}_i}$ where $S_{\overline{\mathcal{H}}_i}$ is projection of S onto $\overline{\mathcal{H}}_i$. Its coefficients are the same as the block of S in (block) column i and (block) line j . Let us show that this block is nameblind.

Consider two subspaces $\overline{\mathcal{H}}_i$ (corresponding to the block column/line i in S) and $\overline{\mathcal{H}}_j$ (column/line j), and a renaming R that is external for g . We may for instance take $\overline{\mathcal{H}}_i$ with states of the form $|axy\rangle_I$, where $a \in g$ and x, y span all external addresses. The block of S specifying what part of $\overline{\mathcal{H}}_i$ goes to $\overline{\mathcal{H}}_j$ is $S_{[i,j]}$. Let $|\mathbf{w}\rangle \in \overline{\mathcal{H}}_i$ be a state. On one hand, as $|\mathbf{w}\rangle$ and $R|\mathbf{w}\rangle$ both belong to $\overline{\mathcal{H}}_i$, they are handled by the same block column i of S (they are in the same subspace, as R does not modify or change the position of a , and make no internal address appear):

$$\Pi_j(SR|\mathbf{w}\rangle) = S_{[i,j]}R|\mathbf{w}\rangle$$

On the other hand :

$$\begin{aligned} \Pi_j(SR|\mathbf{w}\rangle) &= \Pi_j(RS|\mathbf{w}\rangle) \\ &= \Pi_j\left(\sum_{w \in \overline{\mathcal{H}}_j} \alpha_w |R(w)\rangle + \sum_{w \notin \overline{\mathcal{H}}_j} \alpha_w |R(w)\rangle\right) \\ &= R\left(\sum_{w \in \overline{\mathcal{H}}_j} \alpha_w |w\rangle\right) \\ &= RS_{[i,j]}|\mathbf{w}\rangle, \end{aligned}$$

where in the third line we used that R preserves subspaces and thus commutes with Π_j . As a consequence, for all $|\mathbf{w}\rangle, R$ we have $S_{[i,j]}R|\mathbf{w}\rangle = RS_{[i,j]}|\mathbf{w}\rangle$, and therefore $S_{[i,j]}$ is nameblind.

Therefore, if a gate operator commutes with every renaming on external addresses, its matrix representation can be written blockwise with nameblind matrices. Vice versa, if a gate operator S can be partitioned blockwise as above into nameblind matrices, we can write

$$RS = R \sum_i \sum_j S_{[i,j]} = \sum_i \sum_j \left(S_{[i,j]} R \right) = \left(\sum_i \sum_j S_{[i,j]} \right) R = SR.$$

◀

When handling the nameblind blocks $S_{[i,j]}$, we may simply consider that S is acting on a state of the form $|x_1 \dots x_m\rangle$ where x_i are external addresses, and ignore the internal addresses and the specific subspaces in which are the external addresses, as those does not change. Therefore, by Prop. 15 these operators are isomorphic to (m, n) -nameblind matrices and can hence be written blockwise as (n, n) -nameblind matrices by Thm. 13.

D Combining AQC

The AQC model encompasses indefinite causal orders, thus several types of links between AQCs are possible :

Parallel composition of AQCs corresponds to executing them in parallel without interaction.

Concatenation of AQCs corresponds to successively applying them to the quantum data.

Connection of AQCs is also defined, and allows for a more general connectivity without assuming an intrinsic (temporal) order between AQCs.

D.1 Parallel composition

The simplest combination of AQCs is parallel composition, which intuitively means executing them both side by side, separately:

► **Definition 37** (Parallel composition). *Let \mathcal{A}, \mathcal{B} be two disjoint address sets, and let $C_{\mathcal{A}}$ and $C_{\mathcal{B}}$ be the corresponding AQC with skeletons $K_{\mathcal{A}} = (\mathcal{A}, \mathcal{G}_{\mathcal{A}}, \mathcal{D}_{\mathcal{A}}^{\leq n}, S_{\mathcal{A}})$ and $K_{\mathcal{B}} = (\mathcal{B}, \mathcal{G}_{\mathcal{B}}, \mathcal{D}_{\mathcal{B}}^{\leq m}, S_{\mathcal{B}})$ and states $|\psi_{\mathcal{A}}\rangle$ and $|\psi_{\mathcal{B}}\rangle$. Their parallel composition $C_{\mathcal{A}} \parallel C_{\mathcal{B}}$ is defined as $((\mathcal{A} \cup \mathcal{B}, \mathcal{G}_{\mathcal{A}} \cup \mathcal{G}_{\mathcal{B}}, \mathcal{Q}_C, S_C), |\psi_C\rangle)$, where $\mathcal{Q}_C = (\mathcal{D}_{\mathcal{A}} \cup \mathcal{D}_{\mathcal{B}})^{\leq m+n}$ and the scattering S_C applies to $g \in \mathcal{G}_{\mathcal{A}}$ the trivial extension $S_{\mathcal{A}}^{g'}$ of $S_{\mathcal{A}}^g$ from \mathcal{A} to $\mathcal{A} \cup \mathcal{B}$ and from $\mathcal{Q}_{\mathcal{A}}$ to \mathcal{Q}_C , and similarly for $g \in \mathcal{G}_{\mathcal{B}}$.*

By trivial extension, we mean that if $g \in \mathcal{G}_{\mathcal{A}}$, then S_C^g acts as the identity on addresses of \mathcal{B} and on data of $\mathcal{Q}_C \setminus \mathcal{Q}_{\mathcal{A}}$.

D.2 Connection

Explicitly including the sectors 1 and 4 in the Bell state creation circuit (see Fig. 1) or sectors 1 and 6 of the quantum switch (see Fig. 4a) helps distinguishing where the data is coming from and where it is going to. AQC are infinitely evolving systems and, as such, may not be perfectly fitted to express finite computations. However, these sectors, which at first sight seem superfluous, provide a unified template to portray finite quantum circuits, possibly followed by a measurement. In other words, they are useful to determine beginning and endpoint of a finite computation, and we use them as sectors where we place our initial data in and take the final data out.

Moreover, the presence of these sectors becomes crucial as soon as we want to compose AQCs and make them interact. Indeed, we will do so by identifying the outgoing sectors of an AQC, with the ingoing sectors of another.

The following definition paves the road to composing AQCs, by making it explicit which sectors can be identified.

► **Definition 38** (Ingoing and outgoing buffer sectors). *Let $((\mathcal{A}, \mathcal{G}, \mathcal{Q}, S), |\psi\rangle)$ be an AQC and $a \in \mathcal{A}$ be an address. We call the sector at a an ingoing buffer sector if*

- a does not occur in $|\psi\rangle$, i.e. the sector cannot be targeted during the evolution,
- $\{a\} \in \mathcal{G}$, and
- $S^{\{a\}} = F$ (the flip – see A.1).

Similarly, we call the sector at a an outgoing buffer sector if

- $|\psi\rangle = |\varepsilon\rangle^a \otimes |\phi\rangle$, i.e. the state of the sector a is initially empty,
- $\{a\} \in \mathcal{G}$, and
- $S^{\{a\}} = F$.

As a consequence, it is possible to “merge” outgoing with ingoing sectors into a single sector having the address of the outgoing buffer sector and the internal state of the ingoing buffer sector, for an example see Fig. 13b.

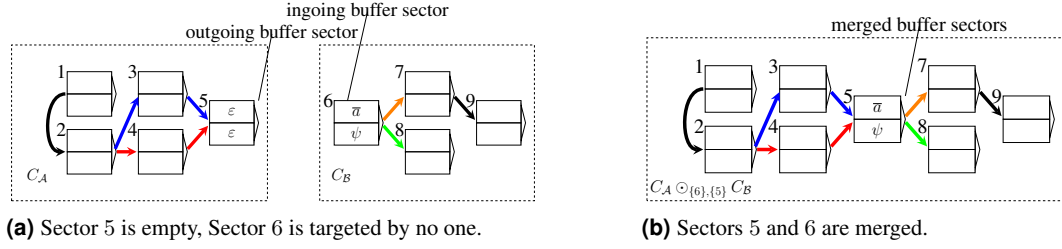

■ **Figure 13** Concatenating two AQCs C_A and C_B along $\{6\}$ and $\{5\}$. In the end, sector 5 is no longer an outgoing buffer sector and sector 6 does not exist anymore.

► **Definition 39** (Connection of AQCs). Let $k \in \mathbb{N}^*$ and $C_1 \dots C_k$ be AQCs with corresponding sets of addresses $\mathcal{A}_1 \dots \mathcal{A}_k$ so that $\forall i \neq j, \mathcal{A}_i \cap \mathcal{A}_j = \emptyset$ and skeletons $K_j = (\mathcal{A}_j, \mathcal{G}_j, \mathcal{Q}_j, S_j)$. Moreover, let $|\psi\rangle$ be the tensor product of their (initial) states, and \mathcal{I}_j and \mathcal{O}_j the sets of their ingoing and outgoing buffer sectors. Let $\mathcal{I} = \{i_1, \dots, i_n\} \subseteq \bigcup_{j=1}^k \mathcal{I}_j$ and $\mathcal{O} = \{o_1, \dots, o_n\} \subseteq \bigcup_{j=1}^k \mathcal{O}_j$ such that $\mathcal{I} \cap \mathcal{O} = \emptyset$. The connection of $C_1 \dots C_k$ along $(\mathcal{I}, \mathcal{O})$ is denoted

$$C = \text{Conn}(\mathcal{I}, \mathcal{O}, \{C_1 \dots C_k\}) = ((\mathcal{A}_C, \mathcal{G}_C, \mathcal{Q}_C, S_C), |\psi_C\rangle)$$

where

- $\mathcal{A}_C = \left(\bigcup_{j=1}^k \mathcal{A}_j \right) \setminus \mathcal{I}$ and $\mathcal{G}_C = \left(\bigcup_{j=1}^k \mathcal{G}_j \right) \setminus \{\{i\}, i \in \mathcal{I}\}$ is the set of addresses of C with corresponding gate set,
- $|\psi_C\rangle = \bigotimes_{a \in \mathcal{A}_C \setminus \mathcal{O}} |\psi_a\rangle^a \otimes \bigotimes_{j=1}^n |\psi_{i_j}\rangle^{o_j}$ when $|\psi\rangle$ is of the form $\bigotimes |\psi_a\rangle^a$, with the general case following by linear extension.
- $\mathcal{Q}_C = \left(\bigcup_{j=1}^k \mathcal{D}_j \right)^{\leq N}$, where $N = \sum_{i=1}^k n_i$ and those n_i are such that $\mathcal{Q}_i = \mathcal{D}_i^{\leq n_i}$.
- S_C is the trivial extension of all S_j as in Def. 37.

The connection of an AQC with the trivial AQC, which consists only of a single empty sector, is the identity operation, given how ingoing and outgoing buffers are merged.

Moreover, note that parallel composition is a special type of connection, where the connecting sectors \mathcal{I} and \mathcal{O} are empty, i.e.

$$C_A || C_B = \text{Conn}(\emptyset, \emptyset, \{C_A, C_B\}).$$

With such a general notion of connection, one may connect an AQCs to form a loop, or even connect an AQC to itself ($\text{Conn}(\mathcal{I}, \mathcal{O}, \{C_A\})$). The resulting AQC may be an evolving structure with neither ingoing nor outgoing buffers.

Such constructions are of course not very physical, since they lack a way for quantum data to enter and or exit, and thus cannot be connected to any other AQC: For an AQC to correspond to a quantum circuit, it has to include at least one ingoing and one outgoing buffer. However, the AQC

model as presented in this paper allows for the definition of more general systems, without an input or an output node. Intuitively, such AQC are not physically implementable as a circuit in a satisfying way, as they lack a way for quantum data to enter and to exit it. They are still causal structures, as the evolution is driven by local reversible rules and gates may be applied on no data, i.e. vacuum states [8]; no causality problem arises if some data enters the same sector twice during the infinite evolution.

The alternative to composition with ingoing and outgoing buffers would have been to manipulate “open AQC”, i.e. featuring addresses that correspond to no sector, and then plugging these open AQCs together. This causes several problems however, as the transport step may be undefined, and renaming only one of the open AQCs may change the nature of the composition.

D.3 Concatenation

Another type of connection is a concatenation : $C_A \odot_{\mathbb{I}, \mathbb{O}} C_B = \text{Conn}(\mathbb{I}, \mathbb{O}, \{C_A, C_B\})$, where \mathbb{I} only contains addresses from \mathcal{B} and \mathbb{O} only address from \mathcal{A} .

Concatenation satisfies some kind of associativity property: for all input (resp. output) sets $\alpha, \beta_1, \beta_2, \gamma$:

$$\beta_1 \cap \beta_2 = \emptyset \quad \Rightarrow \quad (A \odot_{\beta_1, \alpha} B) \odot_{\gamma, \beta_2} C = A \odot_{\beta_1, \alpha} (B \odot_{\gamma, \beta_2} C)$$

Without the condition to the left, the equality on the right holds, but may also be meaningless, as some sectors might have disappeared during the first operation to be applied, or simply not be outgoing or ingoing anymore. Notice that similar to causal boxes [17] and contrary to quantum combs, the concatenation of two AQCs is an AQC.

► **Example 40.** Let us concatenate the quantum switch A defined in Sect. 3.1 and the Bell state creation circuit B of Fig. 1 with address sets $\mathcal{A} = \{1, 2, 3, 4, 5, 6\}$ and $\mathcal{B} = \{7, 8, 9, 0\}$, respectively. As unitaries in the quantum switch, take the Pauli gates $U = Y$ and $V = Z$ on a single qubit. Moreover, to facilitate matters we take $|\psi_A\rangle = |\varepsilon\rangle$ as initial state of the quantum switch so that after concatenation data is only present at the beginning of the Bell state creation circuit. We show in detail the steps of the evolution of A and B concatenated along $\alpha = \{0\}$ and $\beta = \{1\}$ in Fig. 14, where $B \odot_{\alpha, \beta} A = \text{Conn}(\alpha, \beta, \{B, A\})$.

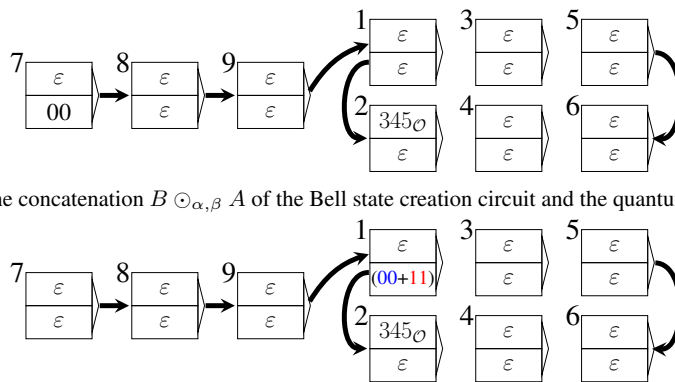

(a) Initial state of the concatenation $B \odot_{\alpha, \beta} A$ of the Bell state creation circuit and the quantum switch.

(b) State of $B \odot_{\alpha, \beta} A$ after the Bell state circuit.

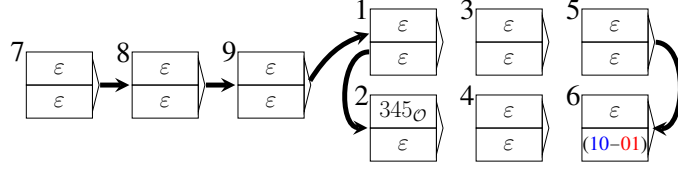

(c) “Final” state of $B \odot_{\alpha,\beta} A$ after the Quantum Switch AQC. A global phase i is omitted.

■ **Figure 14** Evolution of $B \odot_{\alpha,\beta} A$, concatenation of two AQCs of Ex. 40, with initial state 00

E Equivalence between AQC and QCGD

Another approach to represent indefinite causal orders is to shun away from the circuit formalism and take inspiration from cellular automata. The QCGD framework [3] features quantum superpositions of graphs evolving synchronously according to unitary local rules. Each vertex has a local quantum state and communicates with other vertices via ports. Compared to AQCs, vertices have replaced gates and edges have replaced wires.

Like QCGD, our model is able to represent a quantum superposition of different graphs (the graphs of connectivity between gates). The interdiction of non-causal evolution in QCGD may appear as contradictory with the sudden appearance of an edge in the AQC between nodes of different gates — for instance, when an address suddenly goes from the input address space to the target. However, by encoding address spaces into port names, one may simulate this seemingly non-causal edge appearance at the cost of having a larger number of ports —see below. We can therefore encode any AQC into a QCGD. The reverse simulation is a challenging open problem.

Encoding of AQC into the QCGD formalism

A gate operator can be encoded on local unitary rewritings, and multi-sector gates are implemented by connecting its sectors to a central common vertex, via a certain port g .

A minor difficulty is that in an AQC, a sector may suddenly target seemingly far-away sector, whereas in a QCGD, vertices may only connect to closeby vertices. However, when an AQC does this, it is because the far-away sector’s address is a stored address. Therefore, we must encode stored address spaces as QCGD edges.

For clarity purposes, the translation presented here has $3n + 1$ ports and $n + m$ vertices for an AQC with n sectors and m gates, but smaller, less trivial encodings are possible.

► **Definition 41** (Encoding into QCGD). *Let $C = ((\mathcal{A}, \mathcal{G}, \mathcal{Q}, S), |\psi\rangle)$ be an AQC. In the canonical basis of the circuit space, $|\psi\rangle = \sum_k \alpha_k |c_k\rangle$, where each ψ_k is a basis state. The superposition of quantum graphs $e(C) = |\mathbf{G}\rangle = \sum_k \alpha_k |\mathbf{G}_{c_k}\rangle$ encodes C , where each \mathbf{G}_{c_k} is defined as follows:*

- *The set of vertices is : $\mathcal{V} = \{s_a \mid a \in \mathcal{A}\} \cup \{r_g \mid g \in \mathcal{G}\}$ where the vertices $\{s_a \mid a \in \mathcal{A}\}$ represent the sectors, while the vertices $\{r_g \mid g \in \mathcal{G}\}$ represent the gates and will be used to regroup all sectors of a same gate.*
- *Each vertex has ports $\pi = \{p_a \mid a \in \mathcal{A}\} \cup \{e\} \cup \{\tau, in_1, in_2, \dots, in_{|\mathcal{A}|}, out_1, out_2, \dots, out_{|\mathcal{A}|}\}$. The ports $\{p_a \mid a \in \mathcal{A}\}$ are used by the gate-vertices to connect to their sector-vertices and reciprocally. The ports $\{\tau, in_1, in_2, \dots, in_{|\mathcal{A}|}, out_1, out_2, \dots, out_{|\mathcal{A}|}\}$ are used to represent the target space, the input address space and the output address space of the sectors. Any edge from those ports is connected to the entry port e of the corresponding addressed sector-vertex.*

- The set of labels depends on $|c_k\rangle$. Each sector a having a quantum data space containing the state $|\bar{q}\rangle_{\mathcal{Q}_T}^a |\bar{q}'\rangle_{\mathcal{Q}_O}^a$ sees its corresponding vertex s_a being labelled with (\bar{q}, \bar{q}') . Each vertex r_g is labelled with S^g .
- The set of edges depends on $|c_k\rangle$. Each sector a having an address space containing the state $|t\rangle^a |\bar{a}\rangle_{\mathcal{W}_T}^a |\bar{a}'\rangle_{\mathcal{W}_O}^a$ sees its corresponding vertex s_a have the following edges :

$$\{\{s_a : in_i, a_i : e\} \mid \forall a_i \in \bar{a}\}$$

$$\{\{s_a : out_i, a'_i : e\} \mid \forall a'_i \in \bar{a}'\}$$

$$\{s_a : \tau, t : e\}$$

Moreover, each sector a is in a gate g , embodied by the edge :

$$\{s_a : p_a, r_g : p_a\}$$

► **Remark 42.** The condition "address appear at most once in an AQC" in Def. 7 ensures that at most one edge uses the port e of any vertex.

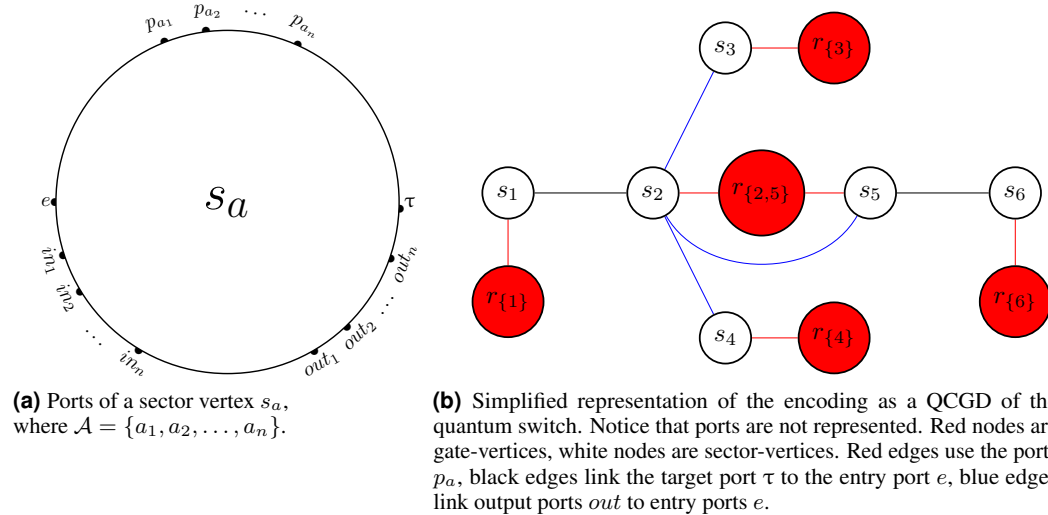

■ **Figure 15**

► **Definition 43 (Evolution of Encoding).** The operator $E = E_T E_S$ is the following quantum causal graph dynamic acting on $|\mathbf{G}_{c_k}\rangle$ by changing the labels and edges of vertices according to the labels and edges of "nearby" vertices:

- E_T implements the transport step. It applies synchronously for every edge $\{s_a : \tau, s_t : e\}$ the following evolution:
 - (Swap of input and output address spaces) For any $j, k \in [1 \dots |\mathcal{A}|]$, the edges $\{s_t : in_j, s_k : e\}$ disappear and are replaced by $\{s_a : out_j, s_k : e\}$, while edges $\{s_a : out_j, s_k : e\}$ disappear and become edges $\{s_t : in_j, s_k : e\}$
 - (Swap of input and output data spaces) Let \bar{q}' be the second part of the label of vertex s_a . Let \bar{p} be the first part of the label of vertex s_t . After applying E_T , the second part of the label of vertex s_a becomes \bar{p} , and the first part of the label of vertex s_t becomes \bar{q}' .
- E_S implements the scattering step. It is synchronously applied on every $r_g \in \mathcal{V}$ of label S^g , corresponding to the gate $g \in \mathcal{G}$, and can be explained by the following substeps :

1. Remember that the vertices $\{s_a \mid a \in g\}$ are exactly the neighbours of vertex r_g . One builds the state of the equivalent AQC-gate space :

$$|\psi\rangle^g = \bigotimes_{a \in g} |\psi\rangle^a,$$

where each $|\psi\rangle^a$ is build from the quantum labelled graph:

- The target space is $|t\rangle$ if there is an edge $\{s_a : \tau, s_t : e\}$. Else, it is $|\varepsilon\rangle$.
 - The input address space contains the (potentially empty) word $\bar{a} = a_1 \dots a_{|\mathcal{A}|}$ where, for each edge $\{s_a : in_i, s_z : e\}$, $a_i = z$. If there exists no such edge for some $i \in [1 \dots |\mathcal{A}|]$, the corresponding a_i is equal to ε .
 - The output address space is filled like the input address space, by replacing every in_i by a out_i in the line above.
 - Let (\bar{q}, \bar{q}') be the label of vertex s_a . The input and output address spaces of sector a are $|\bar{q}\rangle_{\mathcal{Q}_X}^a, |\bar{q}'\rangle_{\mathcal{Q}_O}^a$.
2. S^g (obtained from the label of vertex r_g) is applied to the gate space $\bigotimes_{a \in g} |\psi\rangle^a$, which therefore becomes $|\psi'\rangle^g = S^g \bigotimes_{a \in g} |\psi\rangle^a$
 3. The edges and labels are rewritten from the state $|\psi'\rangle^g$, using the construction explained in step 1 (and Def. 41). in the other direction—this time constructing the subgraph (or potentially a superposition of subgraphs) from the gate space.

► **Proposition 44** (Equivalence of Evolution of Encoding). *Let C be an AQC. Then $e(GC) = Ee(C)$ where $E = E_T E_S$ implements the AQC evolution operator $G = TS$ and with e as in Def. 41.*

F Related works

As we saw in the previous section, AQCs are close to QCGD. In the following, we study links between our model and other approaches to indefinite causal orders in the literature. This additionally contributes to understanding the interest and scope of AQCs.

Quantum circuits with quantum control of causal order

One way is to allow higher-order circuits, with supermaps encoding of quantum control [21], in a way that generalizes the quantum switch. All thus far known physically realizable coherent control of orderings can be expressed within this QC-QC formalism. Notice that these supermaps cannot reuse the same black box twice, as causality is not handled as in AQCs.

It seems that AQC can simulate QC-QC by encoding external operators the action of a gate operator on data and internal operators as their action on addresses. The opposite simulation is more difficult, as the AQC first needs be unfolded over a finite number of steps.

PBS Calculus

A second proposal uses a graphical language inspired by PBS to express causal ordering of general, non unitary quantum channels [9, 4].

The PBS diagram formalism [9] is a graphical language modeling coherent control of "purified channels" [4], i.e. unitary matrices enhanced with ancillæ from an environment, to represent CPTP maps. It provides completeness theorems for coherent quantum control. This control is obtained by having the PBS as a primitive of this graphical language. Similar to AQC, the physical location of quantum data is itself quantum.

Reciprocal simulation between PBS calculus and AQC seems feasible, yet it raises similar challenges as with QC-QC.

Routed quantum circuits

A third idea is to build a process theory [11] which allows for superposition of paths [20].

RQC [20] is an extension of the quantum circuit formalism which allows for communication in a superposition of paths [8]. In this work, the authors describe sectorial constraints to study causal decomposition [15] of the used unitaries. In this purpose they partition Hilbert spaces into sectors, over which they describe with a relation —called a route— which sectors are causally connected.

This is reminiscent of our model as each sector's target may be understood as a specific kind of sectorial constraint. However the formalism of [20] does not allow for a dynamical rewiring of the circuit. For this reason our model seems hard to describe within RQC.

Causal Boxes

A fourth way is to admit superpositions of temporal orders of messages [17]. Causality is ensured by enforcing that each new message depends on messages labelled with lower time tags. This allows for implementations of systems as the quantum switch or a the control of an unknown unitary.

Our model bears similarity to [17], for instance the input and output spaces of sectors are analogous to the input and output wires of causal boxes. Nevertheless, unlike [17] where circuits are fixed, our model is inherently causal *by construction*, despite the dynamical aspect of the wiring structure.

Quantum Shannon Theory with superposition of trajectories

The paper [8] extends the usual Quantum Shannon Theory by allowing trajectories of the information carriers to be superposed. A separation between trajectory and internal quantum information is enforced similar to our separation between addresses and data. If "phase kickback" [10] were to be used to encode supplementary information in the trajectories, they would become part of the message, and the standard Quantum Shannon Theory would be sufficient to express the communication protocol.

In the AQC formalism, all external addresses are handled in the same way. This ensures that the phase kickback only arises from things such as the number of addresses and their position, but never from their value.

G Notations

Let \mathcal{S} be a finite set. We denote by \bar{s} finite strings with alphabet \mathcal{S} , i.e. $\bar{s} = s_1 s_2 \dots s_n$ with $s_i \in \mathcal{S}$. Moreover, ε denotes the empty string. Words of addresses written as letters with overlines (\overline{a}) may be of length 0. Letters without overline (a) represent words of length 1.

From a finite set \mathcal{S} we construct the Hilbert space $\mathcal{H}_{\mathcal{S}} = \mathbb{C}^{\mathcal{S}} = \{\sum_{s \in \mathcal{S}} \alpha_s |s\rangle, \alpha_s \in \mathbb{C}\}$ with scalar product $\langle s|s'\rangle = \delta_{s,s'}$. In other words, to each element $s \in \mathcal{S}$ is associated a unit vector $|s\rangle$, such that the family $(|s\rangle)_{s \in \mathcal{S}}$ is the canonical orthonormal basis of $\mathcal{H}_{\mathcal{S}}$. If \mathcal{S} were countably infinite, we would have ensured square-summability by taking $\mathcal{H} = \ell^2(\mathcal{S})$.

The other notations used in the paper are summarized in Table 1 on the next page.

Notation	Definition	Occurrence
\mathcal{A}	A set of addresses, namely, a finite subset of \mathbb{N} .	Def. 1
\mathcal{G}	A set of gates, namely, a partition of some \mathcal{A} .	Def. 6
\mathcal{T}	A set containing all addresses and the empty address ε , called set of targets.	Def. 1
\mathcal{W}	The set of words on addresses where no address repeats. $\mathcal{W} = \{a_1 \dots a_n a_i \in \mathcal{A}, a_i \neq a_j \forall i, j\}$	Def. 1&18
\bar{a}	A list of addresses. It usually denotes an element of \mathcal{W} or $\mathcal{W} \otimes \mathcal{W}$.	Def. 1
\mathcal{D}	A finite set, called set of data values.	Def. 3
\mathcal{Q}	The set of data words of length at most n for some $n \in \mathbb{N}$ - i.e. $\mathcal{Q} = \mathcal{D}^{\leq n}$.	Def. 3
\bar{q}	An element in \mathcal{Q} .	Def. 3
$\forall S, \mathcal{H}_S$	The Hilbert space constructed from any set S as specified in Sect. G	Sect. G
$\mathcal{H}_{\mathcal{T}}$	Hilbert space on \mathcal{T} called target space.	Def. 1
$\mathcal{H}_{\mathcal{W}}$	Hilbert space on \mathcal{W} called stored address space.	Def. 1
$\mathcal{H}_{\mathcal{Q}}$	Hilbert space on \mathcal{Q} called data space.	Def. 3
\mathcal{H}_I	Input space. It is the tensor product of $\mathcal{H}_{\mathcal{W}}$ and $\mathcal{H}_{\mathcal{Q}}$.	Def. 4
\mathcal{H}_O	Output space. It is the tensor product of $\mathcal{H}_{\mathcal{W}}$ and $\mathcal{H}_{\mathcal{Q}}$.	Def. 4
\mathcal{H}^a	The sector space associated to a . It is the tensor product of $\mathcal{H}_{\mathcal{T}}, \mathcal{H}_I$ and \mathcal{H}_O .	Def. 4&6
\mathcal{H}^g	The sector space associated to a gate $g \subset \mathcal{A} : \mathcal{H}^g = \bigotimes_{a \in g} \mathcal{H}^a$	Def 6
\mathcal{H}	Circuit space. $\mathcal{H} = \bigotimes_{a \in \mathcal{A}} \mathcal{H}^a$	Def. 7
$ a\rangle_{\mathcal{T}}$	A basis state of $\mathcal{H}_{\mathcal{T}}$.	Eq. 5
$ \bar{a}, \bar{q}\rangle_{\mathcal{I}}$	A basis state of $\mathcal{H}_{\mathcal{I}}$.	Ex. 9
$ \bar{a}, \bar{q}\rangle_{\mathcal{O}}$	A basis state of $\mathcal{H}_{\mathcal{O}}$.	Eq. 7
$ \bar{a}, \bar{q}\rangle_{\mathcal{O}}^s$	A basis state of the output space of sector s .	Eq. 2
$ \bar{a}, \bar{a}'\rangle_{\mathcal{W}}$	A basis state of $\mathcal{H}_{\mathcal{W}_I} \otimes \mathcal{H}_{\mathcal{W}_O}$.	Eq. 5
$ \bar{q}, \bar{q}'\rangle_{\mathcal{Q}}$	A basis state of $\mathcal{H}_{\mathcal{Q}_I} \otimes \mathcal{H}_{\mathcal{Q}_O}$.	Eq. 5
$ x\rangle^i$	A basis state of the i -th sector space. It can be decomposed either as : $ a\rangle_{\mathcal{T}}^i \bar{a}, \bar{q}\rangle_{\mathcal{I}}^i \bar{a}', \bar{q}'\rangle_{\mathcal{O}}^i$ or as : $ a\rangle_{\mathcal{T}}^i \bar{a}, \bar{a}'\rangle_{\mathcal{W}}^i \bar{q}, \bar{q}'\rangle_{\mathcal{Q}}^i$	Def. 8
$ x\rangle_y^i$	Where $y \in \{\mathcal{T}, \mathcal{W}, \mathcal{Q}\}$ is the corresponding space of the i -th sector.	Def. 8
$ 32\rangle$	The state $ 3 \ 2\rangle$ (ket–three–two), while being distinct from the state $ 32\rangle$ (ket–thirty–two), is always written as $ 32\rangle$. This causes no confusion, as only address sets with fewer than ten addresses are used in this paper.	Ex. 2
S	The scattering step.	Def. 8
T	The transport step.	Def. 8
G	$G = TS$, the global evolution operator.	Def. 8

■ **Table 1** Notations used in the paper