

# Reduced quantum circuits for stabilizer states and graph states

Marc Bataille  
marc.bataille1@univ-rouen.fr

LITIS laboratory, Université Rouen-Normandie \*

## Abstract

We start by studying the subgroup structures underlying stabilizer circuits and we use our results to propose a new normal form for stabilizer circuits. This normal form is computed by induction using simple conjugation rules in the Clifford group. It has shape CX-CZ-P-H-CZ-P-H, where CX (resp. CZ) denotes a layer of CNOT (resp. CZ) gates, P a layer of phase gates and H a layer of Hadamard gates. Then we consider a normal form for stabilizer states and we show how to reduce the two-qubit gate count in circuits implementing graph states. Finally we carry out a few numerical tests on classical and quantum computers in order to show the practical utility of our methods. All the algorithms described in the paper are implemented in the C language as a Linux command available on GitHub.

## 1 Introduction

In Quantum Computation, any unitary operation can be approximated to arbitrary accuracy using CNOT gates together with Hadamard, Phase, and  $\pi/8$  gates (see Figure 2 for a definition of these gates and [11, Section 4.5.3] for a proof of this result). Therefore, this set of gates is often called the standard set of universal gates. When we restrict this set to Hadamard, Phase and CNOT gates, we obtain the set of Clifford gates. The Pauli group  $\mathcal{E}_n$  is the group generated by the Pauli gates acting on  $n$  qubits (see Figure 1) and the normalizer of the Pauli group in the unitary group  $\mathcal{U}_{2^n}$  is called the Clifford group. In his PhD thesis [7, Section 5.8], Gottesman gave a constructive proof of the fact that any element of the Clifford group can be expressed, up to a global phase factor, as a product of Clifford gates. He also introduced the stabilizer formalism [11, Section 10.5.1], which turned out to be a very efficient tool to analyze quantum error-correction codes [7] and, more generally, to describe unitary dynamics [11, Section 10.5.2]. Indeed, the Gottesman-Knill theorem asserts that a stabilizer circuit (*i.e.* a quantum circuit consisting

---

\*685 Avenue de l'Université, 76800 Saint-Étienne-du-Rouvray. France.

only of Clifford gates) can be simulated efficiently on a classical computer (see [11, Section 10.5.4] and [7, p. 52]).

In the context of quantum stabilizer circuits, the usual denomination *normal form* or *canonical form* just means that any stabilizer circuit is equivalent to a circuit written in this form and that this equivalent circuit is composed of a bounded number of Clifford gates. Generally this equivalent circuit has the shape of a layered decomposition, each layer consisting in a subcircuit composed of a unique type of quantum gate (*e.g.* only CNOT gates, only phase gates). Of course, one tries to find the shortest and simplest decomposition. For simplicity and consistency with the previous works on this topic, we continue using the habitual expression *normal form*, although a more meaningful term would be probably better suited. Due to the importance of the Clifford gates in many fields of Quantum Computation, several normal forms for stabilizer circuits were proposed over the last two decades, with the aim of reducing the gate count in this type of circuits. Indeed, in the experimental quantum computers, the noise in the gate as well as the decoherence time are currently the main causes of their unreliability and it is therefore imperative to minimize the number of gates in quantum circuits. The first normal form proposed by Aaronson and Gottesman [1] was successively improved by Maslov and Roetteler [10], Bravyi and Maslov [4] and Duncan *et al.* [6]. These authors used decomposition methods in the symplectic group over  $\mathbb{F}_2$  in dimension  $2n$  [1, 10, 4] or ZX-calculus [6] in order to compute normal forms. In this paper we provide a new normal form for stabilizer circuits. This form is similar to the most recent ones [4, 6] but it is slightly simpler and we compute it through an original induction process based on conjugation rules in the Clifford group.

Our result is applied to the case of stabilizer states and graph states : we propose a normal form for stabilizer states as well as a new proof of a result due to Van den Nest *et al.* that asserts the local Clifford equivalence of stabilizer states and graph states [13, theorem 1]. Graph states form an important class of stabilizer states that plays a central role in Quantum Information Theory. They are of great use in many fields such as Quantum Computing based on measurements, Quantum Error Correction, or the study of multipartite entanglement (see the numerous references given in the rich introduction of [9]). We show that it is possible to reduce the two-qubit gate count in a circuit implementing a graph state by using an algorithm proposed in 2004 by Patel *et al.* [12] together with some conjugation rules in the Clifford group.

This article is structured as follows. Section 2 is a background section on quantum circuits and Clifford gates that will guide the non-specialist reader through the rest of the paper. In Section 3, we investigate some remarkable subgroups of the Clifford Group and deduce thereby a first normal form for a particular case of stabilizer circuits. In Section 4, we generalize this form to any stabilizer circuits. Finally, in Section 5, we apply this normal form to stabilizer states and we propose an original implementation of graph states. We also provide a few simple statistics to evaluate the practical utility of our method and we consider the case of an implementation of graph states in the publicly available IBM quantum computers.

## 2 Quantum circuits and Clifford gates

In this background section we recall classical notions about quantum circuits and Clifford gates. We also introduce the main notations used in the paper.

Let  $n \geq 1$  be the number of qubit of the considered quantum register. We label each qubit from 0 to  $n - 1$  thus following the usual convention. For coherence we also number the lines and columns of a  $n \times n$  matrix from 0 to  $n - 1$  and we consider that a permutation of the symmetric group  $\mathfrak{S}_n$  is a bijection of  $\{0, \dots, n - 1\}$ . Bold lowercase letters denote a bit vector of dimension  $n$ , *e.g.*  $\mathbf{a} = [a_0, \dots, a_{n-1}]^t$ , where  $a_i \in \mathbb{F}_2$ . In particular, the null vector of  $\mathbb{F}_2^n$  is denoted by  $\mathbf{0}$ . A bit matrix of dimension  $n \times n$  is represented by a bold capital letter (*e.g.*  $\mathbf{I}$ , the identity matrix,  $\mathbf{A}, \mathbf{B}, \dots$ ). The  $\oplus$  symbol denotes the addition in  $\mathbb{F}_2$  (the bitwise XOR) or the symmetric difference between two sets (their union minus their intersection). The  $\otimes$  symbol denotes as usual the Kronecker product of matrices or the tensor product of vector spaces. The  $\odot$  symbol stands for the Hadamard product of two vectors, *i.e.*  $\mathbf{a} \odot \mathbf{b} = \sum_{i=0}^{n-1} a_i b_i \mathbf{e}_i$ , where  $(\mathbf{e}_i)_{i=0..n-1}$  is the canonical basis of  $\mathbb{F}_2^n$ . Unitary matrices of dimension  $2^n \times 2^n$  are represented by italic capital letters (*e.g.*  $I$ , the identity), generally labelled by one or two integers (*e.g.*  $X_i, Z_i, X_{ij}, Z_{ij}$ ), by a vector (*e.g.*  $X_{\mathbf{u}}, Z_{\mathbf{v}}$ ) or by a matrix (*e.g.*  $Z_{\mathbf{B}}, X_{\mathbf{A}}$ ). The complex number equal to  $\sqrt{-1}$  is denoted by a roman  $i$  ( $i^2 = -1$ ), while the labels  $i, j, k \dots$  (integers) are in italic. Classical unitary operators in dimension 2 or 4 (Figure 1 and 2) are represented by typewriter uppercase letters (*e.g.*  $\mathbf{I}, \mathbf{X}, \mathbf{Y}, \mathbf{Z}$  in dimension 2,  $\mathbf{CNOT}, \mathbf{CZ}, \mathbf{SWAP}$  in dimension 4).

In Quantum Information Theory, a qubit is a quantum state that represents the basic information storage unit. This state is described by a ket vector in the Dirac notation  $|\psi\rangle = a_0 |0\rangle + a_1 |1\rangle$  where  $a_0$  and  $a_1$  are complex numbers such that  $|a_0|^2 + |a_1|^2 = 1$ . The value of  $|a_i|^2$  represents the probability that measurement produces the value  $i$ . The states  $|0\rangle$  and  $|1\rangle$  form a basis of the Hilbert space  $\mathcal{H} \simeq \mathbb{C}^2$  where a one qubit quantum system evolves. Operations on qubits must preserve the norm and are therefore described by unitary operators  $U$  in the unitary group  $\mathcal{U}_{2^n}$ . In quantum computation, these operations are represented by quantum gates and a quantum circuit is a conventional representation of the sequence of quantum gates applied to the qubit register over time. In Figure 1, we recall the definition of the Pauli gates mentioned in the introduction. Notice that the states  $|0\rangle$  and  $|1\rangle$  are eigenvectors of the Pauli-Z operator respectively associated to the eigenvalues 1 and -1, so the standard computational basis ( $|0\rangle, |1\rangle$ ) is also called the Z-basis. Let  $x \in \mathbb{F}_2$  be a bit. Notice that  $\mathbf{X} |0\rangle = |1\rangle$  and  $\mathbf{X} |1\rangle = |0\rangle$  (*i.e.*  $\mathbf{X} |x\rangle = |1 \oplus x\rangle$ ), hence the Pauli-X gate is called the NOT gate. The phase gate  $\mathbf{P}$  (see Figure 2) is defined by  $\mathbf{P} |x\rangle = i^x |x\rangle$  and the Hadamard gate  $\mathbf{H}$  creates superposition since  $\mathbf{H} |x\rangle = \frac{1}{\sqrt{2}}(|0\rangle + (-1)^x |1\rangle)$ . The following identities are used frequently in the paper. They are obtained by direct

computation.

$$H^2 = X^2 = Y^2 = Z^2 = I \quad (1)$$

$$XZ = -ZX \quad (2)$$

$$Y = iXZ \quad (3)$$

$$HZH = X \quad (4)$$

$$P^2 = Z \quad (5)$$

$$PXP^{-1} = Y \quad (6)$$

The Pauli group for one qubit is the group generated by the set  $\{X, Y, Z\}$ . Any element of this group can be written uniquely in the form  $i^\lambda X^a Z^b$ , where  $\lambda \in \mathbb{Z}_4$  and  $a, b \in \mathbb{F}_2$ .

<div style="display: flex; justify-content: space-around; align-items: center;"> <div style="text-align: center;">             Pauli-X <math>\square X \square</math> </div> <div style="text-align: center;"> <math>X = \begin{bmatrix} 0 &amp; 1 \\ 1 &amp; 0 \end{bmatrix}</math> </div> <div style="text-align: center;">             Pauli-Y <math>\square Y \square</math> </div> <div style="text-align: center;"> <math>Y = \begin{bmatrix} 0 &amp; -i \\ i &amp; 0 \end{bmatrix}</math> </div> </div>
<div style="display: flex; justify-content: center; align-items: center;"> <div style="text-align: center;">             Pauli-Z <math>\square Z \square</math> </div> <div style="text-align: center;"> <math>Z = \begin{bmatrix} 1 &amp; 0 \\ 0 &amp; -1 \end{bmatrix}</math> </div> </div>

**Figure 1:** The Pauli gates : names, circuit symbols and matrices

A quantum system of two qubits  $A$  and  $B$  (also called a two-qubit register) lives in a 4-dimensional Hilbert space  $\mathcal{H}_A \otimes \mathcal{H}_B$  and the computational basis of this space is  $(|00\rangle = |0\rangle_A \otimes |0\rangle_B, |01\rangle = |0\rangle_A \otimes |1\rangle_B, |10\rangle = |1\rangle_A \otimes |0\rangle_B, |11\rangle = |1\rangle_A \otimes |1\rangle_B)$ . If  $U$  is any unitary operator acting on one qubit, a controlled- $U$  gate acts on the Hilbert space  $\mathcal{H}_A \otimes \mathcal{H}_B$  as follows. One of the two qubits (say qubit  $A$ ) is the control qubit whereas the other qubit is the target qubit. If the control qubit  $A$  is in the state  $|1\rangle$  then  $U$  is applied on the target qubit  $B$  but when qubit  $A$  is in the state  $|0\rangle$  nothing is done on qubit  $B$ . The **CNOT** gate (or **CX** gate) is the controlled- $X$  gate with control on qubit  $A$  and target on qubit  $B$ , so the action of **CNOT** on a two-qubit register is described by : **CNOT**  $|00\rangle = |00\rangle$ , **CNOT**  $|01\rangle = |01\rangle$ , **CNOT**  $|10\rangle = |11\rangle$ , **CNOT**  $|11\rangle = |10\rangle$  (the corresponding matrix is given in Figure 2). Note that this action can be sum up by the simple formula **CNOT**  $|xy\rangle = |x, x \oplus y\rangle$  where  $\oplus$  denotes the XOR operation between two bits  $x$  and  $y$ , which is also the addition in  $\mathbb{F}_2$ . In the same way, the reader can check that the controlled- $Z$  operator acts on a a basis vector as **CZ**  $|xy\rangle = (-1)^{xy} |xy\rangle$ . Notice that this action is invariant by switching the control and the target. The last two-qubit gate we need is the **SWAP** gate defined by **SWAP**  $|xy\rangle = |yx\rangle$ .

A  $n$ -qubit register evolves over time in the Hilbert space  $\mathcal{H}^{\otimes n} = \mathcal{H}_0 \otimes \mathcal{H}_1 \otimes \dots \otimes \mathcal{H}_{n-1}$  where  $\mathcal{H}_i$  is the 2-dimensional Hilbert space of qubit  $i$ . So the vector space of an  $n$ -qubit system has dimension  $2^n$  and a state vector of the standard computational basis is the tensor  $|x_0\rangle \otimes \dots \otimes |x_{n-1}\rangle$ , where  $x_i \in \{0, 1\}$ . This tensor is classically denoted by  $|x\rangle$  (ket  $x$ ), where  $x$  is the binary label  $x_0x_1 \dots x_{n-1}$ . Sometimes it is convenient to identify the binary label  $x = x_0x_1 \dots x_{n-1}$  of  $|x\rangle$  with the column

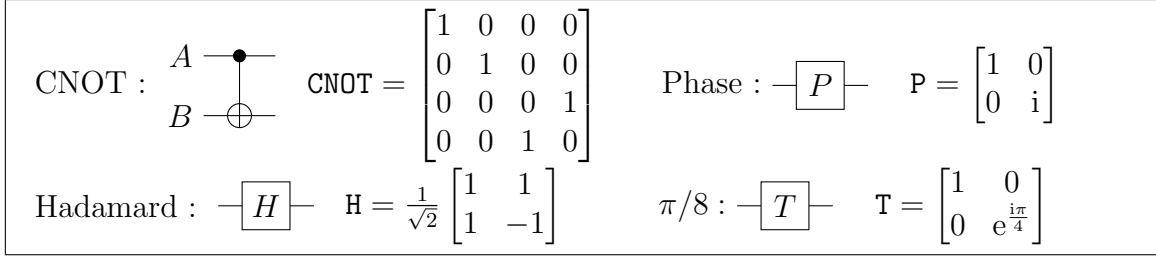

**Figure 2:** The standard set of universal gates : names, circuit symbols and matrices.

vector  $\mathbf{x} = [x_0, \dots, x_{n-1}]^t = \sum_i x_i \mathbf{e}_i$  of the vector space  $\mathbb{F}_2^n$ , so one can label the vectors of the standard basis with  $x$  or with  $\mathbf{x}$  (*i.e.*  $|x\rangle = |\mathbf{x}\rangle$ ).

When we apply locally a single qubit gate  $U$  to the qubit  $i$  of a  $n$ -qubit register, the corresponding action on the  $n$ -qubit system is that of the operator  $U_i = I \otimes \dots \otimes I \otimes U \otimes I \otimes \dots \otimes I = I^{\otimes i} \otimes U \otimes I^{\otimes n-i-1}$ . As an example, if  $n = 4$ ,  $H_1 = I \otimes H \otimes I \otimes I$  and  $H_0 H_3 = H \otimes I \otimes I \otimes H$ . We also use vectors of  $\mathbb{F}_2^n$  as labels for this type of tensor. We write for example  $H_0 H_3 = H_{[1,0,0,1]}^t$  and more generally  $H_{\mathbf{a}} = \prod_i H_i^{a_i}$ . Observe that, with this notation, one has  $U_i = U_{\mathbf{e}_i}$ ,  $U_i^x = U_{x\mathbf{e}_i}$  ( $x \in \{0, 1\}$ ) and  $U_{\mathbf{0}} = I$ . When  $U$  is an involution (*i.e.*  $U^2 = I$ ), the group generated by the  $U_i$ 's is isomorphic to  $\mathbb{F}_2^n$ , since it is an abelian 2-group. This is the case when  $U \in \{X, Y, Z, H\}$  but not when  $U = P$ . For instance  $H_{[1,0,0,1]}^t H_{[0,0,1,1]}^t = H_{[1,0,0,1]^t \oplus [0,0,1,1]^t} = H_{[1,0,1,0]^t} = H_0 H_2$ . Note that the action of  $Z_i$  on  $|x\rangle = |x_0 \dots x_{n-1}\rangle$  is described by  $Z_i |x\rangle = (-1)^{x_i} |x\rangle$ . Hence, if  $\mathbf{v} = [v_0, \dots, v_{n-1}]^t \in \mathbb{F}_2^n$ , one has

$$Z_{\mathbf{v}} |x\rangle = (-1)^{\mathbf{v} \cdot \mathbf{x}} |x\rangle, \quad (7)$$

where  $\mathbf{v} \cdot \mathbf{x} = \sum_i v_i x_i$ . In the same way,  $P_i |x\rangle = i^{x_i} |x\rangle$ , hence

$$P_{\mathbf{v}} |x\rangle = i^{\mathbf{v} \cdot \mathbf{x}} |x\rangle. \quad (8)$$

A CNOT gate with target on qubit  $i$  and control on qubit  $j$  will be denoted  $X_{ij}$  (not to be confused with  $X_i$  which denotes a Pauli-X gate). The reader will pay attention to the fact that our convention is the opposite of that generally used, where  $\text{CNOT}_{ij}$  denotes a CNOT gate with control on qubit  $i$  and target on qubit  $j$ . The reason for this change will appear later in the proof of Theorem 2 (next section). So, if  $i < j$ , the action of  $X_{ij}$  and  $X_{ji}$  on a basis vector  $|x\rangle$  is given by

$$X_{ij} |x\rangle = X_{ij} |x_0 \dots x_i \dots x_j \dots x_{n-1}\rangle = |x_0 \dots x_i \oplus x_j \dots x_j \dots x_{n-1}\rangle, \quad (9)$$

$$X_{ji} |x\rangle = X_{ji} |x_0 \dots x_i \dots x_j \dots x_{n-1}\rangle = |x_0 \dots x_i \dots x_j \oplus x_i \dots x_{n-1}\rangle. \quad (10)$$

The CZ gate between qubits  $i$  and  $j$  is denoted by  $Z_{ij}$  (not to be confused with  $Z_i$  which denotes a Pauli-Z gate). A SWAP gate between qubits  $i$  and  $j$  is denoted by  $S_{ij}$ . Notice that  $Z_{ij} = Z_{ji}$  and  $S_{ij} = S_{ji}$ . These gates are defined by

$$Z_{ij} |x_0 \dots x_{n-1}\rangle = (-1)^{x_i x_j} |x\rangle, \quad (11)$$

$$S_{ij} |x_0 \dots x_i \dots x_j \dots x_{n-1}\rangle = |x_0 \dots x_j \dots x_i \dots x_{n-1}\rangle. \quad (12)$$

Observe that the  $X_{ij}$ ,  $S_{ij}$  and  $X_i$  gates are permutation matrices while the  $Z_{ij}$  and  $Z_i$  gates are diagonal matrices with all diagonal entries equal to 1 or  $-1$ . All these matrices are involutions. The  $P_i$  gates are also diagonal matrices but are not involutions since  $P_i^2 = Z_i$ .

The three classical identities below will be of great use in the paper. They correspond to the circuit equivalences in Figure 3. Each identity can be proved by checking that the actions of its left hand side and its right hand side on any basis vector  $|x\rangle$  are the same.

$$X_{ij} = H_i H_j X_{ji} H_i H_j \quad (13)$$

$$Z_{ij} = H_i X_{ij} H_i = H_j X_{ji} H_j \quad (14)$$

$$S_{ij} = X_{ij} X_{ji} X_{ij} = X_{ji} X_{ij} X_{ji} \quad (15)$$

The Pauli group for  $n$  qubits is the group generated by the set  $\{X_i, Y_i, Z_i \mid i = 0 \dots n-1\}$ . Since Identities (1), (2) and (3) hold, any element of this group can be written uniquely in the form  $i^\lambda X_{\mathbf{u}} Z_{\mathbf{v}}$ , where  $\lambda \in \mathbb{Z}_4$  and  $\mathbf{u}, \mathbf{v} \in \mathbb{F}_2^n$ . So, using (2), the multiplication rule in the Pauli group is given by

$$i^\lambda X_{\mathbf{u}} Z_{\mathbf{v}} i^{\lambda'} X_{\mathbf{u}'} Z_{\mathbf{v}'} = i^{\lambda+\lambda'} (-1)^{\mathbf{u}' \cdot \mathbf{v}} X_{\mathbf{u} \oplus \mathbf{u}'} Z_{\mathbf{v} \oplus \mathbf{v}'}. \quad (16)$$

The unitary matrix corresponding to a stabilizer circuit is an element of the group generated by the set  $\{P_i, H_i, X_{ij} \mid 0 \leq i, j \leq n-1\}$ . This group contains the  $S_{ij}$  and  $Z_{ij}$  gates because of Identities (14) and (15). It also contains the Pauli group, since  $Z_i = P_i^2$ ,  $X_i = H_i P_i^2 H_i$  and  $Y_i = P_i X_i P_i^{-1} = P_i H_i P_i^2 H_i P_i^3$ . In a stabilizer circuit, changes of the overall phase by a multiple of  $\frac{\pi}{4}$  are possible since

$$(H_i P_i)^3 = (P_i H_i)^3 = e^{i\frac{\pi}{4}} I. \quad (17)$$

This last equation can be proved by a direct computation.

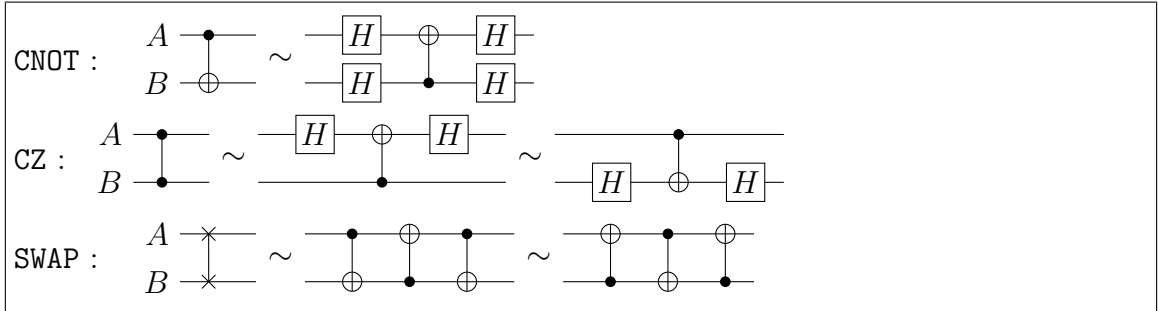

**Figure 3:** Classical equivalences of circuits involving CNOT and Hadamard gates.

## 3 Subgroup structures underlying stabilizer circuits

### 3.1 Quantum circuits of CZ and CNOT gates

We start by describing the group  $\langle \text{CZ} \rangle_n$  which is the group generated by the  $Z_{ij}$  gates acting on  $n$  qubits. Let us denote by  $\mathcal{B}_n$  the power set of  $\{\{i, j\} \mid 0 \leq i < j \leq n-1\}$ .

As noticed in Section 2, the matrices  $Z_{ij}$  are involutions. Besides they commute with each other because they are diagonal matrices. So  $\langle \mathbf{CZ} \rangle_n$  is isomorphic to the abelian 2-group  $(\mathcal{B}_n, \oplus)$ , where  $\oplus$  denotes the symmetric difference of two sets. As a consequence, the order of  $\langle \mathbf{CZ} \rangle_n$  is  $2^{\frac{n(n-1)}{2}}$ . For any  $\mathbf{B}$  in  $\mathcal{B}_n$ , we denote by  $Z_{\mathbf{B}}$  the unitary operator of  $\langle \mathbf{CZ} \rangle_n$  corresponding to the matrix  $\mathbf{B}$ , that is  $Z_{\mathbf{B}} = \prod_{\{i,j\} \in \mathbf{B}} Z_{ij}$ . So the gate  $Z_{ij}$  can also be denoted by  $Z_{\{\{i,j\}\}}$  (we often use the notation  $Z_{\{i,j\}}$  for convenience). Pay attention to the fact that  $Z_{\mathbf{B}}$  denotes a product of  $\mathbf{CZ}$  gates while  $Z_{\mathbf{v}}$  denotes the product of Pauli-Z gates defined by the vector  $\mathbf{v}$ . Using this notation, Identity (11) can be generalized as

$$Z_{\mathbf{B}} |x\rangle = (-1)^{\sum_{\{i,j\} \in \mathbf{B}} x_i x_j} |x\rangle. \quad (18)$$

To any  $\mathbf{B}$  in  $\mathcal{B}_n$ , we associate a  $\mathbb{F}_2$  matrix of dimension  $n \times n$ , whose entry  $(i, j)$  is 1 when  $\{i, j\}$  is in  $\mathbf{B}$  and 0 otherwise. These matrices are symmetric with only zeros on the diagonal and they form an additive group isomorphic to  $(\mathcal{B}_n, \oplus)$ . So, in practice, one can identify the elements of  $\mathcal{B}_n$  to matrices. For example  $\{\{i, j\}\}$  also denotes the matrix whose entries are all 0 but entries  $(i, j)$  and  $(j, i)$  that are equal to 1. Let  $q_{\mathbf{B}}$  be the quadratic form defined on  $\mathbb{F}_2^n$  by

$$q_{\mathbf{B}}(\mathbf{x}) = \sum_{\{i,j\} \in \mathbf{B}} x_i x_j = \sum_{i < j} b_{ij} x_i x_j, \quad (19)$$

where  $b_{ij}$  is the entry  $(i, j)$  of matrix  $\mathbf{B}$ . Then Identity (18) can be rewritten as

$$Z_{\mathbf{B}} |x\rangle = (-1)^{q_{\mathbf{B}}(\mathbf{x})} |x\rangle. \quad (20)$$

Note that  $\mathbf{B}$  can be viewed as the matrix of the alternating (and symmetric) bilinear form associated to the quadratic form  $q_{\mathbf{B}}$ .

In a previous work [2], we described the group  $\langle \mathbf{CNOT} \rangle_n$  generated by the  $X_{ij}$  gates acting on  $n$  qubits. We recall now some results from this work. The special linear group on any field  $K$  is generated by the set of transvection matrices. In the special case of  $K = \mathbb{F}_2$ , this set is reduced to the  $n(n-1)$  matrices  $\mathbf{I} \oplus \mathbf{E}_{ij}$ , where  $\mathbf{E}_{ij}$  is the matrix with all entries 0 except the entry  $(i, j)$  that is equal to 1. Let us denote by  $[ij]$  the transvection matrix  $\mathbf{I} \oplus \mathbf{E}_{ij}$ . The general linear group  $\text{GL}_n(\mathbb{F}_2)$  is equal to  $\text{SL}_n(\mathbb{F}_2)$ , the special linear group on  $\mathbb{F}_2$ , and is consequently generated by the matrices  $[ij]$ . The following simple property of the matrices  $[ij]$  will be frequently used in the rest of the article.

**Proposition 1.** *Multiplying to the left (resp. the right) any matrix  $M$  by a transvection matrix  $[ij]$  is equivalent to add the row  $j$  (resp. column  $i$ ) to the row  $i$  (resp. column  $j$ ) in  $M$ .*

Applying Proposition 1 to the column vector  $\mathbf{x} \in \mathbb{F}_2^n$  corresponding to the binary label  $x$  of the basis vector  $|x\rangle$ , we can rewrite Relation (9) in a cleaner way as

$$X_{ij} |x\rangle = |[ij]\mathbf{x}\rangle. \quad (21)$$

The above considerations lead quite naturally to the following theorem.

**Theorem 2.** *The group  $\langle \text{CNOT} \rangle_n$  generated by the CNOT gates acting on  $n$  qubits is isomorphic to  $\text{GL}_n(\mathbb{F}_2)$ . The morphism  $\Phi$  sending each gate  $X_{ij}$  to the transvection matrix  $[ij]$  is an explicit isomorphism. The order of  $\langle \text{CNOT} \rangle_n$  is  $2^{\frac{n(n-1)}{2}} \prod_{i=1}^n (2^i - 1)$ .*

*Proof.* As the matrices  $[ij]$  generate  $\text{GL}_n(\mathbb{F}_2)$ , it is clear that  $\Phi$  is surjective. Since Identity (21) holds, a preimage  $U$  under  $\Phi$  of any matrix  $\mathbf{A}$  in  $\text{GL}_n(\mathbb{F}_2)$  must satisfy the relations  $U|x\rangle = |\mathbf{A}\mathbf{x}\rangle$  for any basis vector  $|x\rangle$ . As these relations define a unique matrix  $U$ ,  $\Phi$  is injective. The order of  $\text{GL}_n(\mathbb{F}_2)$  is classically obtained by counting the number of basis of the vector space  $\mathbb{F}_2^n$ .  $\square$

For any  $\mathbf{A}$  in  $\text{GL}_n(\mathbb{F}_2)$ , let  $X_{\mathbf{A}} = \Phi^{-1}(\mathbf{A})$ , where  $\Phi$  is the morphism defined in Theorem 2. The unitary operator  $X_{\mathbf{A}}$  thus corresponds to any circuit composed of the CNOT gates  $X_{i_1 j_1} \dots X_{i_\ell j_\ell}$  such that  $\mathbf{A} = \prod_{k=1}^{\ell} [i_k j_k]$  and the gate  $X_{ij}$  can also be denoted by  $X_{[ij]}$ . Pay attention to the fact that  $X_{\mathbf{A}}$  denotes a product of CNOT gates while  $X_{\mathbf{u}}$  denotes the product of Pauli-X gates defined by the vector  $\mathbf{u}$ . As  $([ij][jk])^2 = [ik]$ , a straightforward consequence of the isomorphism between  $\langle \text{CNOT} \rangle_n$  and  $\text{GL}_n(\mathbb{F}_2)$  is the following conjugation rule between the CNOT gates.

$$X_{[ij]}X_{[jk]}X_{[ij]} = X_{[ik]}X_{[jk]} = X_{[jk]}X_{[ik]} \quad (i, j, k \text{ distinct}) \quad (22)$$

### 3.2 The PZX form for quantum circuits of phase, CZ and CNOT gates

Let  $\langle \text{P, CZ} \rangle_n$  be the group generated by the set  $\{P_i, Z_{ij} \mid 0 \leq i, j \leq n-1\}$ . Any element of the group generated by the  $P_i$  gates can be written uniquely in the form  $Z_{\mathbf{v}}P_{\mathbf{b}}$  where  $\mathbf{v}, \mathbf{b} \in \mathbb{F}_2^n$ . This group is isomorphic to  $(\mathbb{Z}_4^n, +)$ , one possible isomorphism associating  $Z_{\mathbf{v}}P_{\mathbf{b}}$  to  $2\mathbf{v} + \mathbf{b}$ . As the generators of the group  $\langle \text{P, CZ} \rangle_n$  commute between each other, the group  $\langle \text{P, CZ} \rangle_n$  is isomorphic to the direct product  $\mathbb{Z}_4^n \times \mathcal{B}_n$ . Any element in  $\langle \text{P, CZ} \rangle_n$  can be written uniquely in the form  $Z_{\mathbf{v}}P_{\mathbf{b}}Z_{\mathbf{B}}$  and

$$Z_{\mathbf{v}}P_{\mathbf{b}}Z_{\mathbf{B}}Z_{\mathbf{v}'}P_{\mathbf{b}'}Z_{\mathbf{B}'} = Z_{\mathbf{v} \oplus \mathbf{v}' \oplus \mathbf{b} \oplus \mathbf{b}'}P_{\mathbf{b} \oplus \mathbf{b}'}Z_{\mathbf{B} \oplus \mathbf{B}'}. \quad (23)$$

The conjugation by the  $X_{[ij]}$  gates in  $\langle \text{P, CZ} \rangle_n$  obey to the seven rules below. Each equality can be proved by checking, thanks to Identities (7) to (11), that the actions of its left hand side and its right hand side on any basis vector  $|x\rangle$  are the same.

$$X_{[ij]}Z_{\{i,j\}}X_{[ij]} = Z_{\{i,j\}}Z_j \quad (24)$$

$$X_{[ij]}Z_{\{i,k\}}X_{[ij]} = Z_{\{i,k\}}Z_{\{j,k\}} \quad (i, j, k \text{ distinct}) \quad (25)$$

$$X_{[ij]}Z_{\{p,q\}}X_{[ij]} = Z_{\{p,q\}} \quad (p, q \neq i) \quad (26)$$

$$X_{[ij]}Z_iX_{[ij]} = Z_iZ_j \quad (27)$$

$$X_{[ij]}Z_jX_{[ij]} = Z_j \quad (28)$$

$$X_{[ij]}P_iX_{[ij]} = P_iP_jZ_{\{i,j\}} \quad (29)$$

$$X_{[ij]}P_jX_{[ij]} = P_j \quad (30)$$

Let us denote by  $\langle \text{P, CZ, CNOT} \rangle_n$  the group generated by the set  $\{P_i, Z_{ij}, X_{ij} \mid 0 \leq i, j \leq n-1\}$ . As described in the following proposition, we can extend relations (24) to (30) to the unitary matrices  $Z_{\mathbf{v}}, P_{\mathbf{b}}$  and  $Z_{\mathbf{B}}$ .



**Proposition 3.** *The group  $\langle \mathbf{P}, \mathbf{CZ} \rangle_n$  is a normal subgroup of  $\langle \mathbf{P}, \mathbf{CZ}, \mathbf{CNOT} \rangle_n$ . The conjugation of any element of  $\langle \mathbf{P}, \mathbf{CZ} \rangle_n$  by a CNOT gate is described by the relations*

$$X_{[ij]} Z_{\mathbf{v}} X_{[ij]} = Z_{[ji]\mathbf{v}} , \quad (31)$$

$$X_{[ij]} P_{\mathbf{b}} X_{[ij]} = Z_{b_i b_j \mathbf{e}_j} P_{[ji]\mathbf{b}} Z_{\{i,j\}^b} = Z_{b_i b_j \mathbf{e}_j} P_{[ji]\mathbf{b}} Z_{b_i \{\{i,j\}\}} , \quad (32)$$

$$X_{[ij]} Z_{\mathbf{B}} X_{[ij]} = Z_{b_{ij} \mathbf{e}_j} Z_{[ji]\mathbf{B}[ij]} , \quad (33)$$

*Proof.* Identities (31) and (32) are direct consequences of the conjugation relations (27), (28), (29), (30) and Proposition (1) applied to the vectors  $\mathbf{v}$  and  $\mathbf{b}$ . Let us prove Identity (33). Let  $\mathbf{B}_i = \{\{p, q\} \in \mathbf{B} \mid i \in \{p, q\}\}$ ,  $\mathbf{B}_i^c = \mathbf{B}_i \oplus \mathbf{B}$  and  $\mathbf{B}'_i = \mathbf{B}_i \oplus b_{ij} \{\{i, j\}\}$ , then  $\mathbf{B} = b_{ij} \{\{i, j\}\} \oplus \mathbf{B}'_i \oplus \mathbf{B}_i^c$ . On one hand,  $[ji]\mathbf{B}[ij] = b_{ij} [ji] \{\{i, j\}\} [ij] \oplus [ji]\mathbf{B}'_i [ij] \oplus [ji]\mathbf{B}_i^c [ij]$ . We check that  $[ji] \{\{i, j\}\} [ij] = \{\{i, j\}\}$ ,  $[ji] \{\{i, k\}\} [ij] = \{\{i, k\}, \{j, k\}\}$  when  $k \neq j$  and  $[ji] \{\{p, q\}\} [ij] = \{\{p, q\}\}$  when  $p, q \neq i$  (recall that  $\{\{p, q\}\}$  denotes the matrix in  $\mathcal{B}_n$  whose entries are 0 but entries  $(p, q)$  and  $(q, p)$  that are 1). Hence

$$Z_{[ji]\mathbf{B}[ij]} = Z_{ij}^{b_{ij}} Z_{\mathbf{B}_i^c} \prod_{k \in \Lambda_i} Z_{ik} Z_{jk} , \quad (34)$$

where  $\Lambda_i = \{k \mid \{i, k\} \in \mathbf{B}'_i\}$ . On the other hand,  $X_{[ij]} Z_{\mathbf{B}} X_{[ij]} = X_{[ij]} Z_{ij}^{b_{ij}} Z_{\mathbf{B}'_i} Z_{\mathbf{B}_i^c} X_{[ij]}$ , so using (24), (25) and (26), one has

$$X_{[ij]} Z_{\mathbf{B}} X_{[ij]} = Z_{ij}^{b_{ij}} Z_j^{b_{ij}} Z_{\mathbf{B}_i^c} \prod_{k \in \Lambda_i} Z_{ik} Z_{jk} . \quad (35)$$

As  $Z_j^{b_{ij}} = Z_{b_{ij} \mathbf{e}_j}$ , we conclude by comparing (34) and (35).  $\square$

We can extend Identity 33 to the case of any unitary matrix  $X_{\mathbf{A}}$ .

**Proposition 4.** *For any matrix  $\mathbf{B}$  in  $\mathcal{B}_n$  and any matrix  $\mathbf{A}$  in  $\text{GL}_n(\mathbb{F}_2)$ , one has*

$$X_{\mathbf{A}} Z_{\mathbf{B}} X_{\mathbf{A}}^{-1} = Z_{q_{\mathbf{B}}(\mathbf{A}^{-1})} Z_{\mathbf{A}^{-t} \mathbf{B} \mathbf{A}^{-1}} , \quad (36)$$

where  $q_{\mathbf{B}}$  is the quadratic form defined by  $\mathbf{B}$ ,  $q_{\mathbf{B}}(\mathbf{A})$  is a shorthand for the vector  $[q_{\mathbf{B}}(\mathbf{c}_0), \dots, q_{\mathbf{B}}(\mathbf{c}_{n-1})]^t$ ,  $\mathbf{c}_0, \dots, \mathbf{c}_{n-1}$  are the columns of matrix  $\mathbf{A}$  and  $\mathbf{A}^{-t}$  is a shorthand for  $(\mathbf{A}^t)^{-1}$ .

*Proof.* Since Identities (33) and (31) hold, it is clear that  $X_{\mathbf{A}} Z_{\mathbf{B}} X_{\mathbf{A}}^{-1}$  can be written in the form  $Z_{\mathbf{v}} Z_{\mathbf{A}^{-t} \mathbf{B} \mathbf{A}^{-1}}$  for some  $\mathbf{v}$  in  $\mathbb{F}_2^n$ . So we have to prove that  $\mathbf{v} = q_{\mathbf{B}}(\mathbf{A}^{-1})$ . We start from  $Z_{\mathbf{v}} = X_{\mathbf{A}} Z_{\mathbf{B}} X_{\mathbf{A}}^{-1} Z_{\mathbf{B}'}$ , where  $\mathbf{B}' = \mathbf{A}^{-t} \mathbf{B} \mathbf{A}^{-1}$ . Let  $|\psi\rangle = Z_{\mathbf{v}} |\mathbf{e}_i\rangle$ , then  $|\psi\rangle = (-1)^{v_i} |\mathbf{e}_i\rangle$ . On the other hand,  $|\psi\rangle = X_{\mathbf{A}} Z_{\mathbf{B}} X_{\mathbf{A}}^{-1} |\mathbf{e}_i\rangle$  since  $q_{\mathbf{B}'}(\mathbf{e}_i) = 0$  for any  $\mathbf{B}' \in \mathcal{B}_n$ . Besides,  $X_{\mathbf{A}}^{-1} |\mathbf{e}_i\rangle = |\mathbf{A}^{-1} \mathbf{e}_i\rangle = |\mathbf{c}_i\rangle$  where  $\mathbf{c}_i$  is the column  $i$  of  $\mathbf{A}^{-1}$ , hence  $|\psi\rangle = X_{\mathbf{A}} Z_{\mathbf{B}} |\mathbf{c}_i\rangle = (-1)^{q_{\mathbf{B}}(\mathbf{c}_i)} X_{\mathbf{A}} |\mathbf{c}_i\rangle = (-1)^{q_{\mathbf{B}}(\mathbf{c}_i)} |\mathbf{e}_i\rangle$ . Finally we see that  $v_i = q_{\mathbf{B}}(\mathbf{c}_i)$ , thus  $\mathbf{v} = q_{\mathbf{B}}(\mathbf{A}^{-1})$ .  $\square$

From Identity (15), the gate  $S_{ij}$  is in  $\langle \mathbf{CNOT} \rangle_n$  and is therefore a gate of type  $X_{\mathbf{A}}$ . Let  $(ij)$  be the permutation matrix of  $\text{GL}_n(\mathbb{F}_2)$  associated to the transposition  $\tau$  of  $\mathfrak{S}_n$  that swaps  $i$  and  $j$ , then  $(ij) = [ij][ji][ij] = [ji][ij][ji]$ , hence  $S_{ij} = X_{[ij]} X_{[ji]} X_{[ij]} =$

$X_{[ij][j][ij]} = X_{(ij)}$ . The group generated by the  $X_{(ij)}$  gates is a subgroup of  $\langle \text{CNOT} \rangle_n$  that is isomorphic to  $\mathfrak{S}_n$  and we denote by  $X_\sigma$  the unitary matrix associated to the permutation matrix  $\sigma$  in  $\text{GL}_n(\mathbb{F}_2)$ . The conjugation by  $X_\sigma$  is given by  $X_\sigma Z_{\{p,q\}} X_\sigma = Z_{\{\sigma(p),\sigma(q)\}}$  and, in particular, one has  $X_{(ij)} Z_{\{p,q\}} X_{(ij)} = Z_{\{\tau(p),\tau(q)\}}$  (see [3] for further development on CZ and SWAP gates). As a consequence of Propositions 3 and 4, the followings identities hold :

$$X_{(ij)} Z_{\mathbf{v}} X_{(ij)} = Z_{(ij)\mathbf{v}} , \quad (37)$$

$$X_{(ij)} P_{\mathbf{b}} X_{(ij)} = P_{(ij)\mathbf{b}} , \quad (38)$$

$$X_{(ij)} Z_{\mathbf{B}} X_{(ij)} = Z_{(ij)\mathbf{B}(ij)} , \quad (39)$$

$$X_\sigma Z_{\mathbf{B}} X_\sigma^{-1} = Z_{\sigma\mathbf{B}\sigma^{-1}} \text{ (for any permutation matrix } \sigma\text{)}. \quad (40)$$

Proposition 3 provides straightforwardly an algorithm to write in normal form any quantum circuit  $C$  composed of P, CZ and CNOT gates. This normal form is called the PZX form (Theorem 5) and the algorithm is called the C-to-PZX algorithm (Figure 4).

**ALGORITHM :** Compute the PZX form for a stabilizer circuit of P, CZ and CNOT gates.  
**INPUT :**  $(C, F_{\text{in}})$ , where  
 $C$  is a circuit given as a matrix product  $C = \prod_{k=1}^{\ell} M_k$ , of  $\ell$  quantum gates in the set  $\{P_i, Z_{\{i,j\}}, X_{[ij]} \mid 0 \leq i, j \leq n-1\}$ ,  
 $F_{\text{in}}$  is a circuit which is already in PZX form .  
**OUTPUT :**  $F_{\text{out}}$  is a circuit equivalent to the product  $CF_{\text{in}}$ , written in PZX form  $Z_{\mathbf{v}} P_{\mathbf{b}} Z_{\mathbf{B}} X_{\mathbf{A}}$ .

```

1  /* initialisation of the form  $F_{\text{out}}$  */
2   $F_{\text{out}} \leftarrow F_{\text{in}}$ ;
3  for  $k = \ell$  to 1 do
4    /* Case a :  $M_k$  is a CZ gate */
5    if  $M_k = Z_{\{i,j\}}$  then
6       $\mathbf{B} \leftarrow \mathbf{B} \oplus \{\{i, j\}\}$  ;
7    /* Case b :  $M_k$  is a P gate */
8    else if  $M_k = P_i$  then
9       $\mathbf{v} \leftarrow \mathbf{v} \oplus b_i \mathbf{e}_i$  ;  $\mathbf{b} \leftarrow \mathbf{b} \oplus \mathbf{e}_i$  ;
10   /* Case c :  $M_k$  is a CNOT gate */
11   else
12      $\mathbf{v} \leftarrow [ji]\mathbf{v} \oplus b_i b_j \mathbf{e}_j \oplus b_{ij} \mathbf{e}_j$  ;
13      $\mathbf{B} \leftarrow [ji]\mathbf{B}[ij] \oplus b_i \{\{i, j\}\}$  ;
14      $\mathbf{b} \leftarrow [ji]\mathbf{b}$  ;  $\mathbf{A} \leftarrow [ij]\mathbf{A}$  ;
15   return  $F_{\text{out}}$ ;

```

**Figure 4:** Algorithm C-to-PZX : the time complexity of this algorithm is only  $O(n\ell)$  since we use row and column additions instead of matrix multiplication in Case c (thanks to Proposition 1). At the end of the algorithm, the matrix  $\mathbf{A}$  is the product of all the transvections corresponding to the CNOT gates that appear in the input circuit  $C$ , in the same order.

**Theorem 5 (The PZX form for a quantum circuit of P, CZ and CNOT gates).**  
Any element of  $\langle P, CZ, CNOT \rangle_n$  admits a unique decomposition in the form

$$Z_{\mathbf{v}} P_{\mathbf{b}} Z_{\mathbf{B}} X_{\mathbf{A}}, \quad (41)$$

where  $\mathbf{v}, \mathbf{b} \in \mathbb{F}_2^n$ ,  $\mathbf{B} \in \mathcal{B}_n$ ,  $\mathbf{A} \in \text{GL}_n(\mathbb{F}_2)$ .

The group  $\langle P, CZ, CNOT \rangle_n$  is the semidirect product of its normal subgroup  $\langle P, CZ \rangle_n$  with  $\langle CNOT \rangle_n$ , i.e.  $\langle P, CZ, CNOT \rangle_n = \langle P, CZ \rangle_n \rtimes \langle CNOT \rangle_n$ . The order of  $\langle P, CZ, CNOT \rangle_n$  is therefore  $2^{n(n+1)} \prod_{i=1}^n (2^i - 1)$ .

*Proof.* The existence of the decomposition can be proved by using the C-to-PZX algorithm described in Figure 4 : let  $\ell \geq 0$  be an integer and  $C = \prod_{k=1}^{\ell} M_k$  be an element of  $\langle P, CZ, CNOT \rangle_n$ , where  $M_k$  is a unitary in the gate set  $\{P_i, Z_{ij}, X_{[ij]} \mid 0 \leq i, j \leq n-1\}$ . Then the form  $Z_{\mathbf{v}} P_{\mathbf{b}} Z_{\mathbf{B}} X_{\mathbf{A}}$  for  $C$  is the result of Algorithm C-to-PZX applied to  $C$  and  $F_{\text{in}} = I$ , that is :  $Z_{\mathbf{v}} P_{\mathbf{b}} Z_{\mathbf{B}} X_{\mathbf{A}} = \text{C-to-PZX}(C, I)$ . Let us prove, by contradiction, the unicity of this decomposition. Suppose that  $Z_{\mathbf{v}} P_{\mathbf{b}} Z_{\mathbf{B}} X_{\mathbf{A}} = Z_{\mathbf{v}'} P_{\mathbf{b}'} Z_{\mathbf{B}'} X_{\mathbf{A}'}$ . If  $\mathbf{A} \neq \mathbf{A}'$ , there exists  $\mathbf{x} \in \mathbb{F}_2^n$  such that  $\mathbf{A}\mathbf{x} \neq \mathbf{A}'\mathbf{x}$ . But this leads to a contradiction because  $Z_{\mathbf{v}} P_{\mathbf{b}} Z_{\mathbf{B}} X_{\mathbf{A}} |\mathbf{x}\rangle = Z_{\mathbf{v}'} P_{\mathbf{b}'} Z_{\mathbf{B}'} X_{\mathbf{A}'} |\mathbf{x}\rangle$ , so  $Z_{\mathbf{v}} P_{\mathbf{b}} Z_{\mathbf{B}} |\mathbf{A}\mathbf{x}\rangle = Z_{\mathbf{v}'} P_{\mathbf{b}'} Z_{\mathbf{B}'} |\mathbf{A}'\mathbf{x}\rangle$ , hence  $|\mathbf{A}\mathbf{x}\rangle$  and  $|\mathbf{A}'\mathbf{x}\rangle$  are two different basis vector that are collinear, which is impossible. So  $\mathbf{A} = \mathbf{A}'$  and  $Z_{\mathbf{v}} P_{\mathbf{b}} Z_{\mathbf{B}} = Z_{\mathbf{v}'} P_{\mathbf{b}'} Z_{\mathbf{B}'}$ . If  $\mathbf{b} \neq \mathbf{b}'$ , we can suppose, without loss of generality, that there exists  $i$  such that  $b_i = 1$  and  $b'_i = 0$ . Then  $P_{\mathbf{b}} |\mathbf{e}_i\rangle = i |\mathbf{e}_i\rangle$  and  $P_{\mathbf{b}'} |\mathbf{e}_i\rangle = |\mathbf{e}_i\rangle$ , so  $i Z_{\mathbf{v}} Z_{\mathbf{B}} |\mathbf{e}_i\rangle = Z_{\mathbf{v}'} Z_{\mathbf{B}'} |\mathbf{e}_i\rangle$ , hence  $i |\mathbf{e}_i\rangle = \pm |\mathbf{e}_i\rangle$ , which is not possible. Thus  $\mathbf{b} = \mathbf{b}'$ . Finally, if  $Z_{\mathbf{v}} Z_{\mathbf{B}} = Z_{\mathbf{v}'} Z_{\mathbf{B}'}$ , we show that  $\mathbf{v} = \mathbf{v}'$  and  $\mathbf{B} = \mathbf{B}'$  by comparing their action on  $|\mathbf{e}_i\rangle$  and  $|\mathbf{e}_i \oplus \mathbf{e}_j\rangle$  for any  $i, j$ .

Since  $\langle P, CZ \rangle_n$  is a normal subgroup of  $\langle P, CZ, CNOT \rangle_n$ , the semidirect product structure is a consequence of the existence and uniqueness of the decomposition. The order of  $\langle P, CZ, CNOT \rangle_n$  is computed using Theorem 2.  $\square$

### 3.3 Toolbox of conjugation rules

The C-to-PZX algorithm computes a normal form for particular stabilizer circuits, consisting only of P, CZ and CNOT gates. In the next section, we use the C-to-PZX algorithm as a subroutine called by the main algorithm that computes a normal form for any stabilizer circuit. In order to describe this algorithm, we need some more conjugation rules. Let  $\Omega = \prod_{i=0}^{n-1} H_i$ , let  $U^\Omega = \Omega U \Omega^{-1} = \Omega U \Omega$  for any  $U \in \mathcal{U}_{2^n}$ . We use  $U^{-\Omega}$  as a shorthand notation for  $(U^\Omega)^{-1}$ . The following identities hold.

$$X_{\mathbf{A}}^\Omega = X_{\mathbf{A}^{-t}} \quad (42)$$

$$P_i^\Omega P_i P_i^{-\Omega} = e^{i\frac{\pi}{4}} H_i X_i \quad (43)$$

$$P_i^\Omega Z_{\{i,k\}} P_i^{-\Omega} = Z_{\{i,k\}} X_{[ik]} P_k \quad (44)$$

$$Z_{\{i,j\}}^\Omega P_j Z_{\{i,j\}}^{-\Omega} = P_i^\Omega X_{[ij]} P_j \quad (45)$$

$$Z_{\{i,j\}}^\Omega Z_{\{i,j\}} Z_{\{i,j\}}^{-\Omega} = Z_{\{i,j\}} Z_{\{i,j\}}^\Omega Z_{\{i,j\}} = H_i H_j X_{(ij)} = X_{(ij)} H_i H_j \quad (46)$$

$$Z_{\{i,j\}}^\Omega Z_{\{i,k\}} Z_{\{i,j\}}^{-\Omega} = X_{[jk]} Z_{\{i,k\}} = Z_{\{i,k\}} X_{[jk]} \quad (i, j, k \text{ distinct}) \quad (47)$$

To write a stabilizer circuit in normal form, we also need the conjugation rules of a Pauli product of type  $X_{\mathbf{u}}Z_{\mathbf{v}}$  by the gates  $P_i$ ,  $X_{[ij]}$ ,  $Z_{\{i,j\}}$  and  $\Omega$ .

$$P_i X_{\mathbf{u}} Z_{\mathbf{v}} P_i^{-1} = i^{u_i} X_{\mathbf{u}} Z_{\mathbf{v} \oplus u_i \mathbf{e}_i} \quad (48)$$

$$X_{[ij]} X_{\mathbf{u}} Z_{\mathbf{v}} X_{[ij]} = X_{[ij] \mathbf{u}} Z_{[ij] \mathbf{v}} \quad (49)$$

$$Z_{\{i,j\}} X_{\mathbf{u}} Z_{\mathbf{v}} Z_{\{i,j\}} = (-1)^{u_i u_j} X_{\mathbf{u}} Z_{\mathbf{v} \oplus u_j \mathbf{e}_i \oplus u_i \mathbf{e}_j} = (-1)^{u_i u_j} X_{\mathbf{u}} Z_{\mathbf{v} \oplus \{\{i,j\}\} \mathbf{u}} \quad (50)$$

$$\Omega X_{\mathbf{u}} Z_{\mathbf{v}} \Omega = X_{\mathbf{v}} Z_{\mathbf{u}} \quad (51)$$

The proofs of Identities (42) to (51) are short and simple. They are based on the different conjugation rules already seen in this section and on the observation that, to conjugate by  $\Omega$ , it is just necessary to take in account the indices concerned by the operation (for instance  $Z_{\{i,j\}}^{\Omega} = H_i H_j Z_{\{i,j\}} H_j H_i$ ). We indicate in the tables below the formulas to be used to prove each identity.

Identity...	comes from...	Identity...	comes from...
42	13	47	14, 22
43	17, 4, 6, 3	48	6, 3
44	29, 17, 14	49	31, 4, 13
45	14, 29	50	49, 2, 4
46	14, 15	51	4

Finally, we obtain more general conjugation rules by unitaries of type  $P_{\mathbf{b}}$ ,  $X_{\mathbf{A}}$  or  $Z_{\mathbf{B}}$  by iterating Identities (48), (49) and (50).

$$P_{\mathbf{b}} X_{\mathbf{u}} Z_{\mathbf{v}} P_{\mathbf{b}}^{-1} = i^{\sum u_i} X_{\mathbf{u}} Z_{\mathbf{v} \oplus \sum b_i u_i \mathbf{e}_i} = i^{\sum u_i} X_{\mathbf{u}} Z_{\mathbf{v} \oplus \mathbf{b} \odot \mathbf{u}} \quad (52)$$

$$X_{\mathbf{A}} X_{\mathbf{u}} Z_{\mathbf{v}} X_{\mathbf{A}}^{-1} = X_{\mathbf{A} \mathbf{u}} Z_{\mathbf{A}^{-t} \mathbf{v}} \quad (53)$$

$$Z_{\mathbf{B}} X_{\mathbf{u}} Z_{\mathbf{v}} Z_{\mathbf{B}} = (-1)^{q_{\mathbf{B}}(\mathbf{u})} X_{\mathbf{u}} Z_{\mathbf{v} \oplus \mathbf{B} \mathbf{u}} \quad (54)$$

## 4 The generalized PZX form for stabilizer circuits

In this section we provide an algorithm to compute a normal form for stabilizer circuits. This form is a generalization of the PZX form ( $Z_{\mathbf{v}} P_{\mathbf{b}} Z_{\mathbf{B}} X_{\mathbf{A}}$ ) introduced in the previous section (41).

**Definition 6.** *A unitary matrix  $C$  corresponding to a circuit of Clifford gates is in GenPZX form when it is written in the form*

$$C = e^{i\varphi} H_{\mathbf{r}} Z_{\mathbf{u}} P_{\mathbf{d}} Z_{\mathbf{D}} H_{\mathbf{s}} Z_{\mathbf{v}} P_{\mathbf{b}} Z_{\mathbf{B}} X_{\mathbf{A}}, \quad (55)$$

where  $\mathbf{r}$ ,  $\mathbf{u}$ ,  $\mathbf{d}$ ,  $\mathbf{s}$ ,  $\mathbf{v}$ ,  $\mathbf{b}$  are vectors in  $\mathbb{F}_2^n$ ,  $\mathbf{D}$  and  $\mathbf{B}$  are matrices in  $\mathcal{B}_n$ ,  $\mathbf{A}$  is an invertible matrix in  $\text{GL}_n(\mathbb{F}_2)$ , and  $\varphi \in \{k\frac{\pi}{4}, k \in \mathbb{Z}\}$ .

We remark that, unlike the PZX form, the GenPZX form is not unique. Indeed, from Identity 46, one has  $H_i H_j Z_{\{i,j\}} H_i H_j Z_{\{i,j\}} = Z_{\{i,j\}} H_i H_j X_{(ij)}$ .

## 4.1 Stability properties of an intermediate form

We introduce a form for stabilizer circuits that we use as an intermediary technical step to compute the GenPZX form and we prove three lemmas concerning this intermediate form.

**Definition 7.** *A unitary matrix  $C$  corresponding to a circuit of Clifford gates is in intermediate form when it is written in the form*

$$C = H_{\mathbf{a}} P_{\mathbf{d}} Z_{\mathbf{D}} \Omega e^{i\varphi} X_{\mathbf{u}} Z_{\mathbf{v}} P_{\mathbf{b}} Z_{\mathbf{B}} X_{\mathbf{A}}, \quad (56)$$

where  $\mathbf{a}, \mathbf{d}, \mathbf{u}, \mathbf{v}, \mathbf{b}$  are vectors in  $\mathbb{F}_2^n$ ,  $\mathbf{D}$  and  $\mathbf{B}$  are matrices in  $\mathcal{B}_n$ ,  $\mathbf{A}$  is an invertible matrix in  $\text{GL}_n(\mathbb{F}_2)$ , and  $\varphi \in \{k\frac{\pi}{4}, k \in \mathbb{Z}\}$

The first lemma is quiet obvious and we write it just to keep our results consistent. The other two lemmas are more technical because we need to distinguish many cases and there are many variables. However, the calculations are simple, essentially based on the different conjugations rules of Section 3. In order to make the reading easier, we use two colors : the **red** color to emphasize a part of an expression which is already in intermediate form and the **blue** color to point out a part of an expression modified by the current computation or to indicate the next gates that we want to merge in the intermediate form. We also use dots ( $\cdot$ ) to separate blocks of unitary matrices.

**Lemma 8.** *The intermediate form (56) is stable by left multiplication by a Hadamard gate : if a unitary matrix  $C$  is in intermediate form, then  $H_i C$  can be written in intermediate form, for any  $i = 0 \dots n - 1$ .*

*Proof.*

$$\begin{aligned} H_i C &= H_{\mathbf{e}_i} H_{\mathbf{a}} P_{\mathbf{d}} Z_{\mathbf{D}} e^{i\varphi} \Omega X_{\mathbf{u}} Z_{\mathbf{v}} P_{\mathbf{b}} Z_{\mathbf{B}} X_{\mathbf{A}} \\ &= H_{\mathbf{a} \oplus \mathbf{e}_i} P_{\mathbf{d}} Z_{\mathbf{D}} e^{i\varphi} \Omega X_{\mathbf{u}} Z_{\mathbf{v}} P_{\mathbf{b}} Z_{\mathbf{B}} X_{\mathbf{A}} \end{aligned}$$

So  $H_i C$  is in intermediate form. □

**Lemma 9.** *The intermediate form (56) is stable by left multiplication by a phase gate : if a unitary matrix  $C$  is in intermediate form, then  $P_i C$  can be written in intermediate form, for any  $i = 0 \dots n - 1$ .*

*Proof.*

$$\begin{aligned} P_i C &= P_i H_{\mathbf{a}} P_{\mathbf{d}} Z_{\mathbf{D}} e^{i\varphi} \Omega X_{\mathbf{u}} Z_{\mathbf{v}} P_{\mathbf{b}} Z_{\mathbf{B}} X_{\mathbf{A}} \\ &= H_{\mathbf{a}} \cdot H_{\mathbf{a}} P_i H_{\mathbf{a}} \cdot P_{\mathbf{d}} Z_{\mathbf{D}} \Omega e^{i\varphi} X_{\mathbf{u}} Z_{\mathbf{v}} P_{\mathbf{b}} Z_{\mathbf{B}} X_{\mathbf{A}} \end{aligned}$$

We distinguish 2 cases, according to the possible values of  $a_i$ .

**Case 1 :**  $a_i = 0$ . In this case  $H_{\mathbf{a}} P_i H_{\mathbf{a}} = P_i$ , so

$$\begin{aligned} P_i C &= H_{\mathbf{a}} \cdot P_i \cdot P_{\mathbf{d}} Z_{\mathbf{D}} \Omega e^{i\varphi} X_{\mathbf{u}} Z_{\mathbf{v}} P_{\mathbf{b}} Z_{\mathbf{B}} X_{\mathbf{A}} \\ &\stackrel{(23)}{=} H_{\mathbf{a}} Z_{\mathbf{d}_i \mathbf{e}_i} P_{\mathbf{d} \oplus \mathbf{e}_i} Z_{\mathbf{D}} \Omega e^{i\varphi} X_{\mathbf{u}} Z_{\mathbf{v}} P_{\mathbf{b}} Z_{\mathbf{B}} X_{\mathbf{A}} \\ &\stackrel{(51)}{=} H_{\mathbf{a}} P_{\mathbf{d} \oplus \mathbf{e}_i} Z_{\mathbf{D}} \Omega e^{i\varphi} X_{\mathbf{u} \oplus \mathbf{d}_i \mathbf{e}_i} Z_{\mathbf{v}} P_{\mathbf{b}} Z_{\mathbf{B}} X_{\mathbf{A}} \end{aligned}$$

and  $P_i C$  is in intermediate form.

Case 2 :  $a_i = 1$ . In this case,  $H_{\mathbf{a}} P_i H_{\mathbf{a}} = P_i^\Omega$ , so

$$P_i C = H_{\mathbf{a}} \cdot P_i^\Omega \cdot P_{\mathbf{d}} Z_{\mathbf{D}} \Omega e^{i\varphi} X_{\mathbf{u}} Z_{\mathbf{v}} P_{\mathbf{b}} Z_{\mathbf{B}} X_{\mathbf{A}}. \quad (57)$$

We use many times conjugation by  $P_i^\Omega$  or  $P_i$  in order to merge  $P_i$  with  $P_{\mathbf{b}}$  :

$$\begin{aligned} P_i C &= H_{\mathbf{a}} \cdot P_i^\Omega P_{\mathbf{d}} P_i^{-\Omega} \cdot P_i^\Omega Z_{\mathbf{D}} P_i^{-\Omega} \cdot \Omega \cdot P_i e^{i\varphi} X_{\mathbf{u}} Z_{\mathbf{v}} P_i^{-1} \cdot P_i P_{\mathbf{b}} Z_{\mathbf{B}} X_{\mathbf{A}} \\ &\stackrel{(23)}{=} H_{\mathbf{a}} \cdot P_i^\Omega P_{\mathbf{d}} P_i^{-\Omega} \cdot P_i^\Omega Z_{\mathbf{D}} P_i^{-\Omega} \cdot \Omega \cdot P_i e^{i\varphi} X_{\mathbf{u}} Z_{\mathbf{v}} P_i^{-1} \cdot Z_{b_i \mathbf{e}_i} P_{\mathbf{b} \oplus \mathbf{e}_i} Z_{\mathbf{B}} X_{\mathbf{A}} \\ &\stackrel{(48)}{=} H_{\mathbf{a}} \cdot P_i^\Omega P_{\mathbf{d}} P_i^{-\Omega} \cdot P_i^\Omega Z_{\mathbf{D}} P_i^{-\Omega} \cdot \Omega \cdot e^{i\varphi} \mathbf{1}^{u_i} X_{\mathbf{u}} Z_{\mathbf{v} \oplus u_i \mathbf{e}_i} \cdot Z_{b_i \mathbf{e}_i} P_{\mathbf{b} \oplus \mathbf{e}_i} Z_{\mathbf{B}} X_{\mathbf{A}} \end{aligned}$$

Let  $\varphi' = \varphi + u_i \frac{\pi}{2}$ ,  $\mathbf{u}' = \mathbf{u}$ ,  $\mathbf{v}' = \mathbf{v} \oplus u_i \mathbf{e}_i \oplus b_i \mathbf{e}_i$  and  $\mathbf{b}' = \mathbf{b} \oplus \mathbf{e}_i$  then

$$P_i C = H_{\mathbf{a}} \cdot P_i^\Omega P_{\mathbf{d}} P_i^{-\Omega} \cdot P_i^\Omega Z_{\mathbf{D}} P_i^{-\Omega} \cdot \Omega e^{i\varphi'} X_{\mathbf{u}'} Z_{\mathbf{v}'} P_{\mathbf{b}'} Z_{\mathbf{B}} X_{\mathbf{A}}.$$

We need to distinguish two subcases, according to the values of  $d_i$ .

Case 2.1 :  $d_i = 0$ . In this case,  $P_i^\Omega P_{\mathbf{d}} P_i^{-\Omega} = P_{\mathbf{d}}$ , so

$$P_i C = H_{\mathbf{a}} P_{\mathbf{d}} \cdot P_i^\Omega Z_{\mathbf{D}} P_i^{-\Omega} \cdot \Omega e^{i\varphi'} X_{\mathbf{u}'} Z_{\mathbf{v}'} P_{\mathbf{b}'} Z_{\mathbf{B}} X_{\mathbf{A}}. \quad (58)$$

Let  $\mathbf{D}_i = \{\{p, q\} \in \mathbf{D} \mid i \in \{p, q\}\}$ , then  $P_i^\Omega Z_{\mathbf{D}} P_i^{-\Omega} = Z_{\mathbf{D} \oplus \mathbf{D}_i} \cdot P_i^\Omega Z_{\mathbf{D}_i} P_i^{-\Omega}$ .

Let  $\Lambda_i = \{k \mid \{k, i\} \in \mathbf{D}\}$ , then

$P_i^\Omega Z_{\mathbf{D}} P_i^{-\Omega} = Z_{\mathbf{D} \oplus \mathbf{D}_i} \cdot \prod_{k \in \Lambda_i} P_i^\Omega Z_{\{i, k\}} P_i^{-\Omega} \stackrel{(44)}{=} Z_{\mathbf{D} \oplus \mathbf{D}_i} \cdot \prod_{k \in \Lambda_i} Z_{\{i, k\}} X_{[ik]} P_k$ , hence

$$P_i C = H_{\mathbf{a}} P_{\mathbf{d}} \cdot Z_{\mathbf{D} \oplus \mathbf{D}_i} \prod_{k \in \Lambda_i} Z_{\{i, k\}} X_{[ik]} P_k \cdot \Omega e^{i\varphi'} X_{\mathbf{u}'} Z_{\mathbf{v}'} P_{\mathbf{b}'} Z_{\mathbf{B}} X_{\mathbf{A}}.$$

We apply the C-to-PZX algorithm with parameters  $C = \prod_{k \in \Lambda_i} Z_{\{i, k\}} X_{[ik]} P_k$  and  $F_{\text{in}} = I$  : let  $Z_{\mathbf{w}'} P_{\mathbf{d}'} Z_{\mathbf{D}'} X_{\mathbf{A}'} = \text{C-to-PZX}(\prod_{k \in \Lambda_i} Z_{\{i, k\}} X_{[ik]} P_k, I)$ , then  $\mathbf{A}' = \prod_{k \in \Lambda_i} [ik]$  (see Figure 4) and

$$\begin{aligned} P_i C &= H_{\mathbf{a}} P_{\mathbf{d}} Z_{\mathbf{D} \oplus \mathbf{D}_i} Z_{\mathbf{w}'} P_{\mathbf{d}'} Z_{\mathbf{D}'} X_{\mathbf{A}'} \Omega e^{i\varphi'} X_{\mathbf{u}'} Z_{\mathbf{v}'} P_{\mathbf{b}'} Z_{\mathbf{B}} X_{\mathbf{A}} \\ &\stackrel{(23)}{=} H_{\mathbf{a}} \cdot Z_{\mathbf{w}' \oplus \mathbf{d} \oplus \mathbf{d}'} P_{\mathbf{d} \oplus \mathbf{d}'} Z_{\mathbf{D} \oplus \mathbf{D}_i \oplus \mathbf{D}'} \cdot X_{\mathbf{A}'} \Omega e^{i\varphi'} X_{\mathbf{u}'} Z_{\mathbf{v}'} P_{\mathbf{b}'} Z_{\mathbf{B}} X_{\mathbf{A}} \\ &\stackrel{(42)}{=} H_{\mathbf{a}} Z_{\mathbf{w}' \oplus \mathbf{d} \oplus \mathbf{d}'} P_{\mathbf{d} \oplus \mathbf{d}'} Z_{\mathbf{D} \oplus \mathbf{D}_i \oplus \mathbf{D}'} \Omega \cdot e^{i\varphi'} X_{\mathbf{A}'^{-t}} X_{\mathbf{u}'} Z_{\mathbf{v}'} X_{\mathbf{A}'^{-t}}^{-1} \cdot X_{\mathbf{A}'^{-t}} P_{\mathbf{b}'} Z_{\mathbf{B}} X_{\mathbf{A}}, \end{aligned}$$

where  $\mathbf{A}'^{-t} = \prod_{k \in \Lambda_i} [ki]$ . Using the decomposition of  $\mathbf{A}'^{-t}$  in transvections, we iterate Identity (49) on the Pauli block  $X_{\mathbf{u}'} Z_{\mathbf{v}'}$  and computes thereby two vectors  $\mathbf{u}''$  and  $\mathbf{v}''$  such that  $X_{\mathbf{u}''} Z_{\mathbf{v}''} = X_{\mathbf{A}'^{-t}} X_{\mathbf{u}'} Z_{\mathbf{v}'} X_{\mathbf{A}'^{-t}}^{-1}$ . Then, we apply the C-to-PZX algorithm with parameters  $C = X_{\mathbf{A}'^{-t}} = \prod_{k \in \Lambda_i} X_{[ki]}$  and  $F_{\text{in}} = P_{\mathbf{b}'} Z_{\mathbf{B}} X_{\mathbf{A}}$  : let  $Z_{\mathbf{w}''} P_{\mathbf{b}''} Z_{\mathbf{B}''} X_{\mathbf{A}''} = \text{C-to-PZX}(X_{\mathbf{A}'^{-t}}, P_{\mathbf{b}'} Z_{\mathbf{B}} X_{\mathbf{A}})$ , we obtain

$$\begin{aligned} P_i C &= H_{\mathbf{a}} Z_{\mathbf{w}' \oplus \mathbf{d} \oplus \mathbf{d}'} P_{\mathbf{d} \oplus \mathbf{d}'} Z_{\mathbf{D} \oplus \mathbf{D}_i \oplus \mathbf{D}'} \Omega \cdot e^{i\varphi'} X_{\mathbf{u}''} Z_{\mathbf{v}''} \cdot Z_{\mathbf{w}''} P_{\mathbf{b}''} Z_{\mathbf{B}''} X_{\mathbf{A}''} \\ &\stackrel{(51)}{=} H_{\mathbf{a}} P_{\mathbf{d} \oplus \mathbf{d}'} Z_{\mathbf{D} \oplus \mathbf{D}_i \oplus \mathbf{D}'} \Omega e^{i\varphi'} X_{\mathbf{u}'' \oplus \mathbf{w}'' \oplus \mathbf{d} \oplus \mathbf{d}'} Z_{\mathbf{v}'' \oplus \mathbf{w}''} P_{\mathbf{b}''} Z_{\mathbf{B}''} X_{\mathbf{A}''}, \end{aligned}$$

and  $P_i C$  is in intermediate form.

Case 2.2 :  $d_i = 1$ . In this case,  $P_i^\Omega P_d P_i^{-\Omega} = P_i^\Omega P_i P_i^{-\Omega} \cdot P_{\mathbf{d} \oplus \mathbf{e}_i} \stackrel{(43)}{=} e^{i\frac{\pi}{4}} H_i X_i \cdot P_{\mathbf{d} \oplus \mathbf{e}_i}$ , so

$$\begin{aligned} P_i C &= H_{\mathbf{a}} \cdot e^{i\frac{\pi}{4}} H_i X_i P_{\mathbf{d} \oplus \mathbf{e}_i} \cdot P_i^\Omega Z_{\mathbf{D}} P_i^{-\Omega} \cdot \Omega e^{i\varphi'} X_{\mathbf{u}'} Z_{\mathbf{v}'} P_{\mathbf{b}'} Z_{\mathbf{B}} X_{\mathbf{A}} \\ &= H_{\mathbf{a} \oplus \mathbf{e}_i} P_{\mathbf{d} \oplus \mathbf{e}_i} X_i \cdot P_i^\Omega Z_{\mathbf{D}} P_i^{-\Omega} \cdot \Omega e^{i(\varphi' + \frac{\pi}{4})} X_{\mathbf{u}'} Z_{\mathbf{v}'} P_{\mathbf{b}'} Z_{\mathbf{B}} X_{\mathbf{A}} \\ &= H_{\mathbf{a} \oplus \mathbf{e}_i} P_{\mathbf{d} \oplus \mathbf{e}_i} \cdot P_i^\Omega Z_{\mathbf{D}} P_i^{-\Omega} \cdot C' \cdot \Omega e^{i(\varphi' + \frac{\pi}{4})} X_{\mathbf{u}'} Z_{\mathbf{v}'} P_{\mathbf{b}'} Z_{\mathbf{B}} X_{\mathbf{A}}, \end{aligned}$$

where  $C' = (P_i^\Omega Z_{\mathbf{D}} P_i^{-\Omega})^{-1} X_i (P_i^\Omega Z_{\mathbf{D}} P_i^{-\Omega}) = P_i^\Omega Z_{\mathbf{D}} P_i^{-\Omega} X_i P_i^\Omega Z_{\mathbf{D}} P_i^{-\Omega}$ .

Let us reduce  $C'$  : as  $P_i^{-\Omega} = \Omega P_i^{-1} \Omega = \Omega P_i Z_i \Omega \stackrel{(51)}{=} P_i^\Omega X_i = X_i P_i^\Omega$ , we obtain

$$C' = P_i^\Omega Z_{\mathbf{D}} P_i^\Omega P_i^\Omega Z_{\mathbf{D}} X_i P_i^\Omega = P_i^\Omega Z_{\mathbf{D}} Z_i^\Omega Z_{\mathbf{D}} X_i P_i^\Omega \stackrel{(51)}{=} P_i^\Omega Z_{\mathbf{D}} X_i Z_{\mathbf{D}} X_i P_i^\Omega.$$

Applying Identity (54) where  $\mathbf{u} = \mathbf{e}_i$  and  $\mathbf{v} = \mathbf{0}$ , we get  $Z_{\mathbf{D}} X_i Z_{\mathbf{D}} = X_i Z_{\mathbf{D}\mathbf{e}_i}$ , hence  $C' = P_i^\Omega X_i Z_{\mathbf{D}\mathbf{e}_i} X_i P_i^\Omega$ . As  $\mathbf{D}\mathbf{e}_i$  is the column  $i$  of matrix  $\mathbf{D}$ , the  $i$ -th bit of the vector  $\mathbf{D}\mathbf{e}_i$  is 0, so  $Z_{\mathbf{D}\mathbf{e}_i}$  commutes with  $X_i$  and  $X_{\mathbf{D}\mathbf{e}_i}$  commutes with  $P_i$ . Hence

$$C' = P_i^\Omega Z_{\mathbf{D}\mathbf{e}_i} P_i^\Omega = \Omega P_i \Omega Z_{\mathbf{D}\mathbf{e}_i} \Omega P_i \Omega \stackrel{(51)}{=} \Omega P_i X_{\mathbf{D}\mathbf{e}_i} P_i \Omega = \Omega X_{\mathbf{D}\mathbf{e}_i} Z_i \Omega. \text{ So}$$

$$\begin{aligned} P_i C &= H_{\mathbf{a} \oplus \mathbf{e}_i} P_{\mathbf{d} \oplus \mathbf{e}_i} \cdot P_i^\Omega Z_{\mathbf{D}} P_i^{-\Omega} \cdot \Omega X_{\mathbf{D}\mathbf{e}_i} Z_i \Omega \cdot \Omega e^{i(\varphi' + \frac{\pi}{4})} X_{\mathbf{u}'} Z_{\mathbf{v}'} P_{\mathbf{b}'} Z_{\mathbf{B}} X_{\mathbf{A}} \\ &= H_{\mathbf{a} \oplus \mathbf{e}_i} P_{\mathbf{d} \oplus \mathbf{e}_i} \cdot P_i^\Omega Z_{\mathbf{D}} P_i^{-\Omega} \cdot \Omega X_{\mathbf{D}\mathbf{e}_i} Z_i e^{i(\varphi' + \frac{\pi}{4})} X_{\mathbf{u}'} Z_{\mathbf{v}'} P_{\mathbf{b}'} Z_{\mathbf{B}} X_{\mathbf{A}} \end{aligned}$$

We merge  $X_{\mathbf{D}\mathbf{e}_i} Z_i$  into the Pauli block  $e^{i(\varphi' + \frac{\pi}{4})} X_{\mathbf{u}'} Z_{\mathbf{v}'}$  by using Identity (16) and obtain thereby a phase  $\varphi''$  and two vectors  $\mathbf{u}''$  and  $\mathbf{v}''$  such that

$$P_i C = H_{\mathbf{a} \oplus \mathbf{e}_i} P_{\mathbf{d} \oplus \mathbf{e}_i} \cdot P_i^\Omega Z_{\mathbf{D}} P_i^{-\Omega} \cdot \Omega e^{i\varphi''} X_{\mathbf{u}''} Z_{\mathbf{v}''} P_{\mathbf{b}'} Z_{\mathbf{B}} X_{\mathbf{A}}. \quad (59)$$

We observe that Equality 59 has the same form as Equality 58. Therefore, to write  $P_i C$  in intermediate form, one can proceed as in Case 2.1, starting from Equality 58.  $\square$

**Lemma 10.** *The intermediate form(56) is stable by left multiplication by a CNOT gate : if a unitary matrix  $C$  is in intermediate form, then  $X_{[ij]} C$  can be written in intermediate form, for any  $i, j = 0 \dots n - 1, i \neq j$ .*

*Proof.*

$$\begin{aligned} X_{[ij]} C &= X_{[ij]} H_{\mathbf{a}} P_{\mathbf{d}} Z_{\mathbf{D}} \Omega e^{i\varphi} X_{\mathbf{u}} Z_{\mathbf{v}} P_{\mathbf{b}} Z_{\mathbf{B}} X_{\mathbf{A}} \\ &= H_{\mathbf{a}} \cdot H_{\mathbf{a}} X_{[ij]} H_{\mathbf{a}} \cdot P_{\mathbf{d}} Z_{\mathbf{D}} \Omega e^{i\varphi} X_{\mathbf{u}} Z_{\mathbf{v}} P_{\mathbf{b}} Z_{\mathbf{B}} X_{\mathbf{A}}. \end{aligned}$$

We need to distinguish 4 cases, according to the values of  $(a_i, a_j)$ .

Case 1 :  $(a_i, a_j) = (0, 0)$ . In this case,  $H_{\mathbf{a}} X_{[ij]} H_{\mathbf{a}} = X_{[ij]}$ , so

$$X_{[ij]} C = H_{\mathbf{a}} \cdot X_{[ij]} \cdot P_{\mathbf{d}} Z_{\mathbf{D}} \Omega e^{i\varphi} X_{\mathbf{u}} Z_{\mathbf{v}} P_{\mathbf{b}} Z_{\mathbf{B}} X_{\mathbf{A}}. \quad (60)$$

We apply the C-to-PZX algorithm with parameters  $C = X_{[ij]}$  and  $F_{\text{in}} = P_{\mathbf{d}} Z_{\mathbf{D}}$  : let  $Z_{\mathbf{v}'} P_{\mathbf{d}'} Z_{\mathbf{D}'} X_{[ij]} = \text{C-to-PZX}(X_{[ij]}, P_{\mathbf{d}} Z_{\mathbf{D}})$ , then

$$\begin{aligned} X_{[ij]} C &= H_{\mathbf{a}} \cdot Z_{\mathbf{v}'} P_{\mathbf{d}'} Z_{\mathbf{D}'} X_{[ij]} \cdot \Omega e^{i\varphi} X_{\mathbf{u}} Z_{\mathbf{v}} P_{\mathbf{b}} Z_{\mathbf{B}} X_{\mathbf{A}} \\ &\stackrel{(13)}{=} H_{\mathbf{a}} Z_{\mathbf{v}'} P_{\mathbf{d}'} Z_{\mathbf{D}'} \Omega \cdot X_{[ij]} e^{i\varphi} X_{\mathbf{u}} Z_{\mathbf{v}} X_{[ij]} \cdot X_{[ij]} P_{\mathbf{b}} Z_{\mathbf{B}} X_{\mathbf{A}} \\ &\stackrel{(49)}{=} H_{\mathbf{a}} Z_{\mathbf{v}'} P_{\mathbf{d}'} Z_{\mathbf{D}'} \Omega \cdot e^{i\varphi} X_{[ij]\mathbf{u}} Z_{[ij]\mathbf{v}} \cdot X_{[ij]} P_{\mathbf{b}} Z_{\mathbf{B}} X_{\mathbf{A}} \\ &\stackrel{(51)}{=} H_{\mathbf{a}} P_{\mathbf{d}'} Z_{\mathbf{D}'} \Omega \cdot e^{i\varphi} X_{[ij]\mathbf{u} \oplus \mathbf{v}'} Z_{[ij]\mathbf{v}} \cdot X_{[ij]} P_{\mathbf{b}} Z_{\mathbf{B}} X_{\mathbf{A}} \end{aligned}$$

We apply the C-to-PZX algorithm with parameters  $C = X_{[ji]}$  and  $F_{\text{in}} = P_{\mathbf{b}}Z_{\mathbf{B}}X_{\mathbf{A}}$  : let  $Z_{\mathbf{v}''}P_{\mathbf{b}''}Z_{\mathbf{B}''}X_{\mathbf{A}''} = \text{C-to-PZX}(X_{[ji]}, P_{\mathbf{b}}Z_{\mathbf{B}}X_{\mathbf{A}})$ , then

$$X_{[ij]}C = H_{\mathbf{a}}P_{\mathbf{d}'}Z_{\mathbf{D}'}\Omega e^{i\varphi}X_{[ji]\mathbf{u}\oplus\mathbf{v}'}Z_{[ij]\mathbf{v}\oplus\mathbf{v}''}P_{\mathbf{b}''}Z_{\mathbf{B}''}X_{\mathbf{A}''},$$

and  $X_{[ij]}C$  is in intermediate form.

**Case 2 :**  $(a_i, a_j) = (1, 1)$ . In this case,  $H_{\mathbf{a}}X_{[ij]}H_{\mathbf{a}} \stackrel{(13)}{=} X_{[ji]}$ , so we proceed as in Case 1, swapping  $i$  and  $j$ .

**Case 3 :**  $(a_i, a_j) = (1, 0)$ . In this case,  $H_{\mathbf{a}}X_{[ij]}H_{\mathbf{a}} \stackrel{(14)}{=} Z_{\{i,j\}}$ , so

$$\begin{aligned} X_{[ij]}C &= H_{\mathbf{a}} \cdot Z_{\{i,j\}} \cdot P_{\mathbf{d}}Z_{\mathbf{D}}\Omega e^{i\varphi}X_{\mathbf{u}}Z_{\mathbf{v}}P_{\mathbf{b}}Z_{\mathbf{B}}X_{\mathbf{A}} \\ &= H_{\mathbf{a}}P_{\mathbf{d}}Z_{\mathbf{D}\oplus\{i,j\}}\Omega e^{i\varphi}X_{\mathbf{u}}Z_{\mathbf{v}}P_{\mathbf{b}}Z_{\mathbf{B}}X_{\mathbf{A}}, \end{aligned}$$

and  $X_{[ij]}C$  is in intermediate form.

**Case 4 :**  $(a_i, a_j) = (0, 1)$ .

In this case,  $H_{\mathbf{a}}X_{[ij]}H_{\mathbf{a}} = H_jX_{[ij]}H_j \stackrel{(14)}{=} H_jH_iZ_{\{i,j\}}H_iH_j = Z_{\{i,j\}}^{\Omega}$  and

$$X_{[ij]}C = H_{\mathbf{a}} \cdot Z_{\{i,j\}}^{\Omega} \cdot P_{\mathbf{d}}Z_{\mathbf{D}}\Omega e^{i\varphi}X_{\mathbf{u}}Z_{\mathbf{v}}P_{\mathbf{b}}Z_{\mathbf{B}}X_{\mathbf{A}}.$$

Here the situation is more complicated because we need two distinguish different subcases, according to the possible values of  $d_{ij}$  (the entry  $(i, j)$  of matrix  $\mathbf{D}$ ) and  $(d_i, d_j)$  (the entries  $i$  and  $j$  of vector  $\mathbf{d}$ ).

**Case 4.1 :**  $d_{ij} = 0$ .

$$\begin{aligned} X_{[ij]}C &= H_{\mathbf{a}} \cdot Z_{\{i,j\}}^{\Omega} P_{\mathbf{d}}Z_{\{i,j\}}^{-\Omega} \cdot Z_{\{i,j\}}^{\Omega} Z_{\mathbf{D}}Z_{\{i,j\}}^{-\Omega} \cdot \Omega \cdot Z_{\{i,j\}} e^{i\varphi} X_{\mathbf{u}} Z_{\mathbf{v}} Z_{\{i,j\}} \cdot Z_{\{i,j\}} P_{\mathbf{b}} Z_{\mathbf{B}} X_{\mathbf{A}} \\ &\stackrel{(50)}{=} H_{\mathbf{a}} \cdot Z_{\{i,j\}}^{\Omega} P_{\mathbf{d}}Z_{\{i,j\}}^{\Omega} \cdot Z_{\{i,j\}}^{\Omega} Z_{\mathbf{D}}Z_{\{i,j\}}^{\Omega} \Omega e^{i\varphi} (-1)^{u_i u_j} X_{\mathbf{u}} Z_{\mathbf{v}\oplus\{i,j\}\mathbf{u}} P_{\mathbf{b}} Z_{\mathbf{B}\oplus\{i,j\}} X_{\mathbf{A}} \end{aligned}$$

Let  $\varphi' = \varphi + u_i u_j \pi$ ,  $\mathbf{u}' = \mathbf{u}$ ,  $\mathbf{v}' = \mathbf{v} \oplus \{\{i, j\}\mathbf{u}\}$  and  $\mathbf{B}' = \mathbf{B} \oplus \{\{i, j\}\}$ , then

$$X_{[ij]}C = H_{\mathbf{a}} \cdot Z_{\{i,j\}}^{\Omega} P_{\mathbf{d}}Z_{\{i,j\}}^{\Omega} \cdot Z_{\{i,j\}}^{\Omega} Z_{\mathbf{D}}Z_{\{i,j\}}^{\Omega} \cdot \Omega e^{i\varphi'} X_{\mathbf{u}'} Z_{\mathbf{v}'} P_{\mathbf{b}} Z_{\mathbf{B}'} X_{\mathbf{A}}.$$

Let  $\mathbf{D}_i = \{\{p, q\} \in \mathbf{D} \mid i \in \{p, q\}\}$  then  $\mathbf{D}_i \cap \mathbf{D}_j = \emptyset$  (since  $d_{ij} = 0$ ) and  $Z_{\{i,j\}}^{\Omega} Z_{\mathbf{D}} Z_{\{i,j\}}^{\Omega} = Z_{\mathbf{D}\oplus\mathbf{D}_i\oplus\mathbf{D}_j} \cdot Z_{\{i,j\}}^{\Omega} Z_{\mathbf{D}_i} Z_{\mathbf{D}_j} Z_{\{i,j\}}^{\Omega}$ .

Let  $\Lambda_i = \{k \mid \{i, k\} \in \mathbf{D}\}$ , then

$Z_{\{i,j\}}^{\Omega} Z_{\mathbf{D}} Z_{\{i,j\}}^{\Omega} = Z_{\mathbf{D}\oplus\mathbf{D}_i\oplus\mathbf{D}_j} \cdot Z_{\{i,j\}}^{\Omega} \cdot \prod_{k \in \Lambda_i} Z_{\{i,k\}} \cdot \prod_{k \in \Lambda_j} Z_{\{j,k\}} \cdot Z_{\{i,j\}}^{\Omega}$ , so

$$Z_{\{i,j\}}^{\Omega} Z_{\mathbf{D}} Z_{\{i,j\}}^{\Omega} \stackrel{(47)}{=} Z_{\mathbf{D}\oplus\mathbf{D}_i\oplus\mathbf{D}_j} \cdot \prod_{k \in \Lambda_i} Z_{\{i,k\}} X_{[jk]} \cdot \prod_{k \in \Lambda_j} Z_{\{j,k\}} X_{[ik]}.$$

Note that no phase gate is created when one applies the C-to-PZX algorithm to a sequence of CNOT and CZ gates as in the expression of  $Z_{\{i,j\}}^{\Omega} Z_{\mathbf{D}} Z_{\{i,j\}}^{\Omega}$  above (see Figure 4) : let  $Z_{\mathbf{w}'} Z_{\mathbf{D}'} X_{\mathbf{A}'} = \text{C-to-PZX}(Z_{\{i,j\}}^{\Omega} Z_{\mathbf{D}} Z_{\{i,j\}}^{\Omega}, I)$ , then  $\mathbf{A}' = \prod_{k \in \Lambda_i} [jk] \prod_{k \in \Lambda_j} [ik]$  and

$$\begin{aligned} X_{[ij]}C &= H_{\mathbf{a}} \cdot Z_{\{i,j\}}^{\Omega} P_{\mathbf{d}}Z_{\{i,j\}}^{\Omega} \cdot Z_{\mathbf{w}'} Z_{\mathbf{D}'} X_{\mathbf{A}'} \cdot \Omega e^{i\varphi'} X_{\mathbf{u}'} Z_{\mathbf{v}'} P_{\mathbf{b}} Z_{\mathbf{B}'} X_{\mathbf{A}} \\ &\stackrel{(42)}{=} H_{\mathbf{a}} \cdot Z_{\{i,j\}}^{\Omega} P_{\mathbf{d}}Z_{\{i,j\}}^{\Omega} \cdot Z_{\mathbf{w}'} Z_{\mathbf{D}'} \cdot \Omega \cdot e^{i\varphi'} X_{\mathbf{A}'\rightarrow t} X_{\mathbf{u}'} Z_{\mathbf{v}'} X_{\mathbf{A}'t} \cdot X_{\mathbf{A}'\rightarrow t} P_{\mathbf{b}} Z_{\mathbf{B}'} X_{\mathbf{A}}, \end{aligned}$$



where  $\mathbf{A}'^{-t} = \prod_{k \in \Lambda_i} [kj] \prod_{k \in \Lambda_j} [ki]$ . Using the decomposition of  $\mathbf{A}'^{-t}$  in transvections, we iterate Identity (49) on the Pauli block  $X_{\mathbf{u}'} Z_{\mathbf{v}'}$  and computes thereby two vectors  $\mathbf{u}''$  and  $\mathbf{v}''$  such that  $X_{\mathbf{u}''} Z_{\mathbf{v}''} = X_{\mathbf{A}'^{-t}} X_{\mathbf{u}'} Z_{\mathbf{v}'} X_{\mathbf{A}'^{-t}}^{-1}$ . Then we apply the C-to-PZX algorithm with parameters  $C = X_{\mathbf{A}'^{-t}} = \prod_{k \in \Lambda_i} X_{[kj]} \prod_{k \in \Lambda_j} X_{[ki]}$  and  $F_{\text{in}} = P_{\mathbf{b}} Z_{\mathbf{B}'} X_{\mathbf{A}}$ : let  $Z_{\mathbf{w}''} P_{\mathbf{b}''} Z_{\mathbf{B}''} X_{\mathbf{A}''} = \text{C-to-PZX}(X_{\mathbf{A}'^{-t}}, P_{\mathbf{b}} Z_{\mathbf{B}'} X_{\mathbf{A}})$ , we obtain

$$\begin{aligned} X_{[ij]} C &= H_{\mathbf{a}} \cdot Z_{\{i,j\}}^{\Omega} P_{\mathbf{d}} Z_{\{i,j\}}^{\Omega} \cdot Z_{\mathbf{w}'} Z_{\mathbf{D}'} \cdot \Omega \cdot e^{i\varphi'} X_{\mathbf{u}''} Z_{\mathbf{v}''} \cdot Z_{\mathbf{w}''} P_{\mathbf{b}''} Z_{\mathbf{B}''} X_{\mathbf{A}''} \\ &\stackrel{(51)}{=} H_{\mathbf{a}} \cdot Z_{\{i,j\}}^{\Omega} P_{\mathbf{d}} Z_{\{i,j\}}^{\Omega} \cdot Z_{\mathbf{D}'} \Omega e^{i\varphi'} X_{\mathbf{u}'' \oplus \mathbf{w}'} Z_{\mathbf{v}'' \oplus \mathbf{w}''} P_{\mathbf{b}''} Z_{\mathbf{B}''} X_{\mathbf{A}''}. \end{aligned}$$

Case 4.1.1 :  $(d_i, d_j) = (0, 0)$ . In this case,  $Z_{\{i,j\}}^{\Omega} P_{\mathbf{d}} Z_{\{i,j\}}^{\Omega} = P_{\mathbf{d}}$ , so

$$X_{[ij]} C = H_{\mathbf{a}} P_{\mathbf{d}} Z_{\mathbf{D}'} \Omega e^{i\varphi'} X_{\mathbf{u}'' \oplus \mathbf{w}'} Z_{\mathbf{v}'' \oplus \mathbf{w}''} P_{\mathbf{b}''} Z_{\mathbf{B}''} X_{\mathbf{A}''},$$

and  $X_{ij} C$  is in intermediate form.

Case 4.1.2 :  $(d_i, d_j) = (0, 1)$ . In this case,

$Z_{\{i,j\}}^{\Omega} P_{\mathbf{d}} Z_{\{i,j\}}^{\Omega} = Z_{\{i,j\}}^{\Omega} P_j Z_{\{i,j\}}^{\Omega} P_{\mathbf{d} \oplus \mathbf{e}_j} \stackrel{(45)}{=} P_i^{\Omega} X_{[ij]} P_j P_{\mathbf{d} \oplus \mathbf{e}_j} = P_i^{\Omega} X_{[ij]} P_{\mathbf{d}}$ , hence

$$\begin{aligned} X_{[ij]} C &= H_{\mathbf{a}} \cdot P_i^{\Omega} X_{[ij]} P_{\mathbf{d}} \cdot Z_{\mathbf{D}'} \Omega e^{i\varphi'} X_{\mathbf{u}'' \oplus \mathbf{w}'} Z_{\mathbf{v}'' \oplus \mathbf{w}''} P_{\mathbf{b}''} Z_{\mathbf{B}''} X_{\mathbf{A}''} \\ &= H_{\mathbf{a}} P_i^{\Omega} \cdot X_{[ij]} P_{\mathbf{d}} Z_{\mathbf{D}'} \Omega e^{i\varphi'} X_{\mathbf{u}'' \oplus \mathbf{w}'} Z_{\mathbf{v}'' \oplus \mathbf{w}''} P_{\mathbf{b}''} Z_{\mathbf{B}''} X_{\mathbf{A}''}. \end{aligned}$$

We can merge  $X_{[ij]}$  in the red part using the same computation as in Case 1, starting from Equality (60) where  $\mathbf{a} = \mathbf{0}$ . We obtain

$$X_{[ij]} C = H_{\mathbf{a}} \cdot P_i^{\Omega} F_1, \tag{61}$$

where  $F_1$  is an intermediate form such that  $\mathbf{a} = \mathbf{0}$ , because no Hadamard gate is created in Case 1. So, in order to merge  $P_i^{\Omega}$  with  $F_1$ , we can use the same computation as in Case 2 of the proof of Lemma 9, starting from Equality 57. We obtain

$$X_{[ij]} C = H_{\mathbf{a}} F_2,$$

where  $F_2$  is an intermediate form. Finally, we merge  $H_{\mathbf{a}}$  with  $F_2$  using Lemma 8, and obtain thereby a rewriting in intermediate form for  $X_{[ij]} C$ .

Case 4.1.3 :  $(d_i, d_j) = (1, 0)$ . We proceed as in case 4.1.2, swapping  $i$  and  $j$ .

Case 4.1.4 :  $(d_i, d_j) = (1, 1)$ . In this case,

$Z_{\{i,j\}}^{\Omega} P_{\mathbf{d}} Z_{\{i,j\}}^{\Omega} = Z_{\{i,j\}}^{\Omega} P_j P_i Z_{\{i,j\}}^{\Omega} P_{\mathbf{d} \oplus \mathbf{e}_i \oplus \mathbf{e}_j} \stackrel{(45)}{=} P_i^{\Omega} X_{[ij]} P_j P_j^{\Omega} X_{[ji]} P_i P_{\mathbf{d} \oplus \mathbf{e}_i \oplus \mathbf{e}_j}$ .

Since Identity (30) holds,  $P_j^{\Omega} X_{[ji]}$  and  $P_i P_{\mathbf{d} \oplus \mathbf{e}_i \oplus \mathbf{e}_j}$  commutes, so

$Z_{\{i,j\}}^{\Omega} P_{\mathbf{d}} Z_{\{i,j\}}^{\Omega} = P_i^{\Omega} X_{[ij]} P_{\mathbf{d}} P_j^{\Omega} X_{[ji]}$ . Hence

$$\begin{aligned} X_{[ij]} C &= H_{\mathbf{a}} \cdot P_i^{\Omega} X_{[ij]} P_{\mathbf{d}} P_j^{\Omega} X_{[ji]} \cdot Z_{\mathbf{D}'} \Omega e^{i\varphi'} X_{\mathbf{u}'' \oplus \mathbf{w}'} Z_{\mathbf{v}'' \oplus \mathbf{w}''} P_{\mathbf{b}''} Z_{\mathbf{B}''} X_{\mathbf{A}''} \\ &= H_{\mathbf{a}} P_i^{\Omega} X_{[ij]} P_{\mathbf{d}} P_j^{\Omega} \cdot X_{[ji]} Z_{\mathbf{D}'} \Omega e^{i\varphi'} X_{\mathbf{u}'' \oplus \mathbf{w}'} Z_{\mathbf{v}'' \oplus \mathbf{w}''} P_{\mathbf{b}''} Z_{\mathbf{B}''} X_{\mathbf{A}''} \end{aligned}$$

We can merge  $X_{[ij]}$  in the red part using Case 1, starting from Equality 60 in the special case where  $\mathbf{a} = \mathbf{d} = \mathbf{0}$ . We obtain

$$X_{[ij]}C = H_{\mathbf{a}}P_i^\Omega X_{[ij]}P_{\mathbf{d}} \cdot P_j^\Omega F_1,$$

where  $F_1$  is an intermediate form such that  $\mathbf{a} = \mathbf{d} = \mathbf{0}$ . So, in order to merge  $P_j^\Omega$  with  $F_1$ , we can use the same computation as in Case 2 and Case 2.1 of the proof of Lemma 9, starting from Equality 57 where  $\mathbf{d} = \mathbf{0}$ . We obtain thereby an intermediate form  $F_2$  such that  $\mathbf{a} = \mathbf{0}$  because no Hadamard gate is created in these cases :

$$X_{[ij]}C = H_{\mathbf{a}}P_i^\Omega X_{[ij]} \cdot P_{\mathbf{d}}F_2.$$

As  $\mathbf{a} = \mathbf{0}$  in the intermediate form  $F_2$ , we can use Case 1 of the proof of Lemma 9 to merge  $P_{\mathbf{d}}$  with  $F_2$ . We obtain

$$X_{[ij]}C = H_{\mathbf{a}}P_i^\Omega \cdot X_{[ij]}F_3,$$

where  $F_3$  is an intermediate form such that  $\mathbf{a} = \mathbf{0}$ . So, we can use again Case 1 to merge  $X_{[ij]}$  with  $F_3$  and obtain

$$X_{[ij]}C = H_{\mathbf{a}} \cdot P_i^\Omega F_4,$$

where  $F_4$  is an intermediate form such that  $\mathbf{a} = \mathbf{0}$ . We note that we are in the same situation as in Case 4.1.2, Equality 61. So we obtain an intermediate form for  $X_{[ij]}C$  by proceeding in the same way.

**Case 4.2 :**  $d_{ij} = 1$ . Let  $\mathbf{D}' = \mathbf{D} \oplus \{\{i, j\}\}$ , then  $d'_{ij} = 0$ , and

$$\begin{aligned} X_{[ij]}C &= H_{\mathbf{a}} \cdot Z_{\{i,j\}}^\Omega Z_{\{i,j\}} \cdot P_{\mathbf{d}}Z_{\mathbf{D}'}\Omega e^{i\varphi} X_{\mathbf{u}}Z_{\mathbf{v}}P_{\mathbf{b}}Z_{\mathbf{B}}X_{\mathbf{A}} \\ &\stackrel{46}{=} H_{\mathbf{a}} \cdot H_i H_j X_{(ij)} Z_{\{i,j\}}^\Omega \cdot P_{\mathbf{d}}Z_{\mathbf{D}'}\Omega e^{i\varphi} X_{\mathbf{u}}Z_{\mathbf{v}}P_{\mathbf{b}}Z_{\mathbf{B}}X_{\mathbf{A}}. \end{aligned}$$

We use the conjugations rules (37), (38) and (39) by the SWAP gate  $X_{(ij)}$  and we merge the Hadamard gates to obtain

$$X_{[ij]}C = H_{\mathbf{a} \oplus \mathbf{e}_i \oplus \mathbf{e}_j} Z_{\{i,j\}}^\Omega P_{(ij)\mathbf{d}} Z_{(ij)\mathbf{D}'(ij)} \Omega e^{i\varphi} X_{(ij)\mathbf{u}} Z_{(ij)\mathbf{v}} P_{(ij)\mathbf{b}} Z_{(ij)\mathbf{B}(ij)} X_{(ij)\mathbf{A}}.$$

Let  $\mathbf{D}'' = (ij)\mathbf{D}'(ij)$ . Since  $d'_{ij} = 0$ , then  $d''_{ij} = 0$ , so we can proceed as in Case 4.1 and obtain thereby an intermediate form for  $X_{[ij]}C$ .  $\square$

## 4.2 Computing the generalized PZX form

We show that a GenPZX form of a stabilizer circuit  $C$  can be obtained in polynomial time by applying an algorithm summarized in Figure 5. This algorithm is called the C-to-GenPZX algorithm.

**Theorem 11 (The GenPZX form for stabilizer circuits).** *Any  $n$ -qubit stabilizer circuit  $C$  given as a product of  $\ell$  Clifford gates, i.e.  $C = \prod_{k=1}^{\ell} M_k$ , where*

$M_k \in \{P_i, H_i, X_{[ij]} \mid 0 \leq i, j \leq n-1\}$ , can be written in polynomial time  $O(\ell n^2)$  in the form

$$e^{i\varphi} H_{\mathbf{r}} Z_{\mathbf{u}} P_{\mathbf{d}} Z_{\mathbf{D}} H_{\mathbf{s}} Z_{\mathbf{v}} P_{\mathbf{b}} Z_{\mathbf{B}} X_{\mathbf{A}}, \quad (62)$$

where  $\mathbf{r}, \mathbf{u}, \mathbf{d}, \mathbf{s}, \mathbf{v}, \mathbf{b}$  are vectors in  $\mathbb{F}_2^n$ ,  $\mathbf{D}$  and  $\mathbf{B}$  are matrices in  $\mathcal{B}_n$ ,  $\mathbf{A}$  is an invertible matrix in  $\text{GL}_n(\mathbb{F}_2)$ , and  $\varphi \in \{k\frac{\pi}{4}, k \in \mathbb{Z}\}$ .

*Proof.* The computation of the GenPZX form is divided into three steps A, B, C. We describe each step and evaluate the number of operations needed to perform the step.

**Step A** : We prove by induction on the length  $\ell$  of the input circuit that any stabilizer circuit  $C = \prod_{k=1}^{\ell} M_k$ , where  $M_k \in \{P_i, H_i, X_{[ij]} \mid 0 \leq i, j \leq n-1\}$ , can be written in the intermediate form  $H_{\mathbf{a}} P_{\mathbf{d}} Z_{\mathbf{D}} \Omega e^{i\varphi} X_{\mathbf{u}} Z_{\mathbf{v}} P_{\mathbf{b}} Z_{\mathbf{B}} X_{\mathbf{A}}$ . The base case of the induction is clear : if  $\ell = 0$ , then  $C = I = H_{\mathbf{a}} \Omega$ , where  $\mathbf{a}$  is the vector of  $\mathbb{F}_2^n$  with all entries equal to 1. To perform an induction step, we must prove that, for any  $M \in \{P_i, H_i, X_{[ij]} \mid 0 \leq i, j \leq n-1\}$  and any Clifford circuit  $C$  in intermediate form, the product  $MC$  can be written in intermediate form. Clearly, the induction step is achieved by using Lemmas 8, 9 and 10.

Taking in account the different cases in the proofs of these three Lemmas, it appears that the algorithmic cost of merging a Clifford gate into the intermediate form is bounded by the cost of the C-to-PZX algorithm. The complexity of the C-to-PZX algorithm is  $O(\ell' n)$ , where  $\ell'$  is the number of gate in the input circuit (see Figure 4). At each induction step, we apply this algorithm to subcircuits composed of  $O(n)$  gates, so the cost of using C-to-PZX is  $O(n^2)$  operations for each step. Starting from a stabilizer circuit  $C$  of length  $\ell$ , one needs  $\ell$  induction steps to write  $C$  in intermediate form, so we see that the number of operations needed in Step A is  $O(\ell n^2)$ .

**Step B** : We write  $C$  in the form  $C = e^{i\varphi} H_{\mathbf{a}} P_{\mathbf{d}} Z_{\mathbf{D}} \cdot X_{\mathbf{u}}^{\Omega} \cdot \Omega Z_{\mathbf{v}} P_{\mathbf{b}} Z_{\mathbf{B}} X_{\mathbf{A}}$  and we use Identity (51) as well as the commutativity of the unitaries  $P_{\mathbf{d}}$ ,  $Z_{\mathbf{D}}$  and  $Z_{\mathbf{u}}$  to obtain  $C = e^{i\varphi} H_{\mathbf{a}} Z_{\mathbf{u}} P_{\mathbf{d}} Z_{\mathbf{D}} \Omega Z_{\mathbf{v}} P_{\mathbf{b}} Z_{\mathbf{B}} X_{\mathbf{A}}$ . The cost of this step is  $O(1)$  (we neglect operations such as initializing or copying which depend on the implementation of the C-to-GenPZX algorithm).

**Step C** : The unitaries  $H_{\mathbf{r}}$  and  $H_{\mathbf{s}}$  appear after a straightforward simplification of the Hadamard gates. One defines the vectors  $\mathbf{r}$  and  $\mathbf{s}$  as follows. Let  $\Gamma$  be the set of qubits involved in the subcircuit  $Z_{\mathbf{u}} P_{\mathbf{d}} Z_{\mathbf{D}}$ , i.e  $\Gamma = \{i \mid u_i = 1\} \cup \{i \mid d_i = 1\} \cup \{i \mid \exists j, d_{ij} = 1\}$ . If  $a_i = 1$  and  $i \notin \Gamma$  then  $r_i = s_i = 0$ , otherwise  $r_i = a_i$  and  $s_i = 1$ . After this last step,  $C = e^{i\varphi} H_{\mathbf{r}} Z_{\mathbf{u}} P_{\mathbf{d}} Z_{\mathbf{D}} H_{\mathbf{s}} Z_{\mathbf{v}} P_{\mathbf{b}} Z_{\mathbf{B}} X_{\mathbf{A}}$ , so  $C$  is in the desired form. The cost of this simplification is  $O(n^2)$ .  $\square$

**Remark 12.** *The space complexity of the C-to-GenPZX algorithm is only  $O(n^2)$  (the space needed to store the matrices) if we merge each Clifford gate  $M_k$  on-the-fly. We proceeded in this way to implement the C-to-GenPZX algorithm as a Linux command “./stabnf” with a text-based user interface. The source code of the command is available at*

**ALGORITHM** : Compute a generalized PZX form for a stabilizer circuit.

**INPUT** :  $C$ , a stabilizer circuit given as a product of Clifford gates.

**OUTPUT** : An equivalent circuit to  $C$ , written in the GenPZX form

$$e^{i\varphi} H_{\mathbf{r}} Z_{\mathbf{u}} P_{\mathbf{d}} Z_{\mathbf{D}} H_{\mathbf{s}} Z_{\mathbf{v}} P_{\mathbf{b}} Z_{\mathbf{B}} X_{\mathbf{A}} ,$$

**Step A** : Write  $C$  in intermediate form.

$$C = H_{\mathbf{a}} P_{\mathbf{d}} Z_{\mathbf{D}} \Omega e^{i\varphi} X_{\mathbf{u}} Z_{\mathbf{v}} P_{\mathbf{b}} Z_{\mathbf{B}} X_{\mathbf{A}}$$

**Step B** : Move the Pauli-X gates to the right.

$$C = e^{i\varphi} H_{\mathbf{a}} Z_{\mathbf{u}} P_{\mathbf{d}} Z_{\mathbf{D}} \Omega Z_{\mathbf{v}} P_{\mathbf{b}} Z_{\mathbf{B}} X_{\mathbf{A}}$$

**Step C** : Simplify the Hadamard gates.

$$C = e^{i\varphi} H_{\mathbf{r}} Z_{\mathbf{u}} P_{\mathbf{d}} Z_{\mathbf{D}} H_{\mathbf{s}} Z_{\mathbf{v}} P_{\mathbf{b}} Z_{\mathbf{B}} X_{\mathbf{A}}$$

**Return**  $e^{i\varphi} H_{\mathbf{r}} Z_{\mathbf{u}} P_{\mathbf{d}} Z_{\mathbf{D}} H_{\mathbf{s}} Z_{\mathbf{v}} P_{\mathbf{b}} Z_{\mathbf{B}} X_{\mathbf{A}}$

**Figure 5:** Algorithm C-to-GenPZX

<https://github.com/marcbataille/stabilizer-circuits-normal-forms>.

The manual mode of the command reproduces the induction steps described in the proofs of Lemmas 8, 9 and 10. In this mode, the user can write in the GenPZX form a stabilizer circuit of arbitrary length and can observe the merging of each new Clifford gate into the normal form.

**Remark 13.** The global phase  $\varphi$  of a quantum circuit is generally considered as irrelevant because it is physically unobservable. However, we decided not to neglect  $\varphi$  during the computation process of the normal form, because knowing its exact value is, at least, of mathematical interest (for instance the group  $\{e^{i\varphi} I | \varphi \in \{k\frac{\pi}{4}, k \in \mathbb{Z}\}\}$  has order 8 and this is related to the order of the group generated by the Clifford gates, see formula in the discussion below). Besides, calculating the exact value of  $\varphi$  does not require much additional work.

**Remark 14.** The C-to-GenPZX algorithm can also take CZ, SWAP, Z, X, or Y gates as input since  $Z_{\{i,j\}} = H_i X_{[ij]} H_i$ ,  $S_{ij} = X_{(ij)} = X_{[ij]} X_{[ji]} X_{[ij]}$ ,  $Z_i = P_i^2$ ,  $X_i = H_i P_i^2 H_i$  and  $Y_i = P_i X_i P_i^{-1} = P_i H_i P_i^2 H_i P_i^3$ . All these gates are accepted as input of the command “./stabnf” in manual mode.

**Remark 15.** The C-to-GenPZX algorithm can be applied to an input circuit consisting only of P, CZ and CNOT gates. In this case, the output circuit is in the PZX form  $Z_{\mathbf{v}} P_{\mathbf{b}} Z_{\mathbf{B}} X_{\mathbf{A}}$ . So the C-to-GenPZX algorithm is an extension of the C-to-PZX algorithm to any stabilizer circuit.

### 4.3 Discussion

We discuss some questions related to the implementation of the GenPZX form as a quantum circuit and we compare the GenPZX form to other recent normal forms for stabilizer circuits.

In order to implement the unitary  $X_{\mathbf{A}}$  of the GenPZX form as a CNOT subcircuit, we need to write the matrix  $\mathbf{A}$  as a product of transvections. To this end, one can apply an algorithm proposed in 2004 by Patel *et al.* [12]. This algorithm

is superior to the classical Gaussian elimination as it allows a decomposition in  $O(n^2/\log n)$  transvections [12, Theorem 1] whereas the number of transvections in the decomposition obtained by the Gauss-Jordan algorithm is bounded by  $n^2$  [2, Proposition 10]. In the rest of this paper, we refer to the Patel *et al.*'s algorithm with parameter  $m$  equal to  $\lceil \log_2(n)/2 \rceil$  as the **A-to-CNOT** algorithm (see [12] for the definition of  $m$ ). It is important to remark that the **A-to-CNOT** algorithm does not return, in general, an optimized decomposition in transvections of the matrix  $\mathbf{A}$ . Of course, it is possible to optimize a CNOT circuit by a brute force algorithm but the cost is exponential and the algorithm can be used in practice only for small values of  $n$ . The method is as follows. First build the Cayley graph of the group  $\text{GL}_n(\mathbb{F}_2)$  by Breadth-first search, then find in this graph the matrix  $\mathbf{A}$  corresponding to that CNOT circuit. We implemented this algorithm in the C language and the source file `cnot_opt.c` is available at

`https://github.com/marcbataille/cnot-circuits/tree/master/optimization`.

Run on a basic laptop, the program allows to optimize in a few seconds any CNOT circuit up to 5 qubits.

Note that the unitary operators  $Z_{\mathbf{u}}P_{\mathbf{d}}$  and  $Z_{\mathbf{v}}P_{\mathbf{b}}$  in the GenPZX form can be implemented as subcircuits of phase gates since  $Z = P^2$ . So the unitary operator described by the GenPZX form can be implemented as a quantum circuit of type

$$CX - CZ - P - H - CZ - P - H, \quad (63)$$

where  $CX$  (resp.  $CZ$ ) is a subcircuit of CNOT (resp. CZ) gates,  $P$  (resp.  $H$ ) is a subcircuit of Phase (resp. Hadamard) gates<sup>1</sup>. The GenPZX form has some similarities with the normal forms proposed in 2020 by Duncan *et al.* [6, Section 6] (H-P-CZ-CX-H-CZ-P-H) or by Bravyi and Maslov [4, lemma 8] (X-Z-P-CX-CZ-H-CZ-H-P). These two forms have, like the form 63, exactly two CZ layers and one CNOT layer but the number of single qubit layers is different. The form H-P-CZ-CX-H-CZ-P-H proposed in [6] contains three layers of Hadamard gates whereas the form 63 contains only two layers of Hadamard gates. If we merge the Z layer with the P layer at the beginning of the form X-Z-P-CX-CZ-H-CZ-H-P [4] (as we did for the form 63), the resulting form contains five single qubit layers, whereas the form 63 contains four single qubit layers. So the normal form proposed in this paper can be considered as a slight simplification of the two forms mentioned above since it contains one single qubit layer less.

The Clifford Group (defined as the normalizer of the Pauli Group in the unitary group  $\mathcal{U}_{2n}$ ) is infinite. However the group generated by the gate set  $\{H_i, P_i, X_{[ij]} \mid 0 \leq i, j \leq n-1\}$  is a finite subgroup of the Clifford Group and its order is  $8 \times 2^{2n} |\text{Sp}_{2n}(\mathbb{F}_2)| = 2^{n^2+2n+3} \prod_{j=1}^n (4^j - 1)$ , where  $\text{Sp}_{2n}(\mathbb{F}_2)$  is the symplectic group over  $\mathbb{F}_2$  in dimension  $2n$  (see *e.g.* [5]). In [10], the authors consider that the number of Boolean degrees of freedom in that group is  $2n^2 + O(n)$ , since its order is  $2^{2n^2+O(n)}$ .

<sup>1</sup>The reader who is not used to quantum circuits must pay attention to the following fact: a circuit acts to the right of the ket  $|\psi\rangle$  presented to its left but the associated operator acts to the left of  $|\psi\rangle$ , so the order of the gates in the circuit 63 is inverted comparing to the GenPZX form 55.

They deduce thereby that a normal form for stabilizer circuits must have at least  $2n^2 + O(n)$  degrees of freedom. As a CNOT layer adds  $n^2$  degrees of freedom, a CZ layer adds  $n(n-1)/2$  degree of freedom and the single qubit layers add a linear amount of degree of freedom (this is a direct consequence of the group orders of  $\langle \text{CZ} \rangle_n$  and  $\langle \text{CNOT} \rangle_n$ , see [10, Section I] and [6, Section 6]), it is easy to see that all three normal forms mentioned in this discussion have  $2n^2 + O(n)$  degrees of freedom and are therefore asymptotically optimal in the sense defined in [10].

## 5 Implementing stabilizer states and graph states

### 5.1 The connection between stabilizer states and graph states

A stabilizer state  $|S\rangle$  for a  $n$ -qubit register can be written in the form

$$|S\rangle = C |0\rangle^{\otimes n}, \quad (64)$$

where  $C$  is a product of Clifford gates [1, Theorem 1]. A graph state  $|G\rangle$  is a special case of a stabilizer state that can be written in the form

$$|G\rangle = Z_{\mathbf{B}} |+\rangle^{\otimes n} = Z_{\mathbf{B}} \Omega |0\rangle^{\otimes n}, \quad (65)$$

where  $|+\rangle = \text{H}|0\rangle = \frac{1}{\sqrt{2}}(|0\rangle + |1\rangle)$  is the eigenvector corresponding to the eigenvalue 1 of the Pauli-X gate,  $Z_{\mathbf{B}}$  is a product of CZ gates defined by a matrix  $\mathbf{B}$  in  $\mathcal{B}_n$  and  $\Omega = \text{H}^{\otimes n}$  [9]. The graph  $G$  associated to the graph state  $|G\rangle$  is the graph of order  $n$  whose vertices are labeled by the  $n$  qubits and whose set of edges is  $\{\{i, j\} \mid b_{ij} = 1\}$ .

Let  $|S\rangle = C |0\rangle^{\otimes n}$  be a stabilizer state. Applying the C-to-GenPZX algorithm up to Step B to the stabilizer circuit  $C$  yields  $C = e^{i\varphi} H_{\mathbf{a}} Z_{\mathbf{u}} P_{\mathbf{d}} Z_{\mathbf{D}} \Omega Z_{\mathbf{v}} P_{\mathbf{b}} Z_{\mathbf{B}} X_{\mathbf{A}}$ . Since the unitary  $Z_{\mathbf{v}} P_{\mathbf{b}} Z_{\mathbf{B}} X_{\mathbf{A}}$  has no effect on the ket  $|0\rangle^{\otimes n}$ , one has, neglecting the global phase  $\varphi$  :  $|S\rangle = H_{\mathbf{a}} Z_{\mathbf{u}} P_{\mathbf{d}} Z_{\mathbf{D}} \Omega |0\rangle^{\otimes n}$ . Hence  $|S\rangle = H_{\mathbf{a}} Z_{\mathbf{u}} P_{\mathbf{d}} |G\rangle$ , where  $|G\rangle$  is the graph state  $Z_{\mathbf{D}} \Omega |0\rangle^{\otimes n}$ . So, using the C-to-GenPZX algorithm, we obtain a new proof of a theorem from Van den Nest *et al.* [13, theorem 1] that asserts the equivalence under local Clifford operations of any stabilizer state  $|S\rangle$  to a graph state  $|G\rangle$  : there exists a stabilizer circuit  $C'$  consisting only of local Clifford gates (*i.e.* phase and Hadamard gates) and a graph state  $|G\rangle$  such that  $|S\rangle = C' |G\rangle$ . Moreover, the C-to-GenPZX algorithm provides a possible construction of the circuit  $C'$  and the graph  $G$ .

**Theorem 16 (Normal form of a stabilizer state).** *For any stabilizer state  $|S\rangle$ , there exists a graph state  $|G\rangle$  and 3 vectors  $\mathbf{a}, \mathbf{u}, \mathbf{d}$  in  $\mathbb{F}_2^n$  such that*

$$|S\rangle = H_{\mathbf{a}} Z_{\mathbf{u}} P_{\mathbf{d}} |G\rangle. \quad (66)$$

Because of Theorem 16, implementing a stabilizer state is equivalent to implementing a graph state, up to a circuit of local Clifford gates. So, in the rest of this section, we focus on the implementation of a graph state as a circuit in a quantum machine.

## 5.2 Reducing the two-qubit gate count of a graph state

We address the following question : what kind of pretreatment can be done in the classical circuit of CZ and Hadamard gates that implements a graph state  $|G\rangle = Z_{\mathbf{B}}|+\rangle^{\otimes n}$  in order to reduce the two-qubit gate count ? We propose an implementation based on the gate set  $\{\mathbf{H}, \mathbf{Z}, \mathbf{CZ}, \mathbf{CNOT}\}$  obtained thanks to the use of Identity (36) ( $X_{\mathbf{A}}Z_{\mathbf{B}}X_{\mathbf{A}}^{-1} = Z_{q_{\mathbf{B}}(\mathbf{A}^{-1})}Z_{\mathbf{A}^{-t}\mathbf{B}\mathbf{A}^{-1}}$ ) together with the A-to-CNOT algorithm. The main idea is as follows. The two-qubit gate count in a CZ circuit is at most  $n(n-1)/2$  gates, while the A-to-CNOT algorithm allows an implementation of  $X_{\mathbf{A}}$  in  $O(n^2/\log n)$  CNOT gates. Hence, if we find an equivalent circuit to the CZ circuit corresponding to the unitary  $Z_{\mathbf{B}}$ , in which the gate count is dominated by the CNOT gates, we can expect a possible reduction of the initial circuit.

**Definition 17.** *We say that a matrix  $\mathbf{B} \in \mathcal{B}_n$  is reduced when each column and each line of  $\mathbf{B}$  contains at most one non-zero entry, i.e.  $Z_{\mathbf{B}}$  corresponds to a CZ circuit of depth 1.*

**Lemma 18.** *For any  $\mathbf{B} \in \mathcal{B}_n$ , there exists an upper triangular matrix  $\mathbf{A} \in \text{GL}_n(\mathbb{F}_2)$  and a reduced matrix  $\mathbf{B}_{\text{red}} \in \mathcal{B}_n$  such that  $\mathbf{B}_{\text{red}} = \mathbf{A}^t\mathbf{B}\mathbf{A}$ .*

*Proof.* The matrix  $\mathbf{B}$  is the matrix of an alternating bilinear form with respect to the canonical basis  $(\mathbf{e}_i)_{i=0\dots n-1}$  of  $\mathbb{F}_2^n$ . The equality  $\mathbf{B}_{\text{red}} = \mathbf{A}^t\mathbf{B}\mathbf{A}$  is just the classical change of basis formula, where  $\mathbf{A}$  is the matrix of the new basis. A possible construction of  $\mathbf{A}$  and  $\mathbf{B}_{\text{red}}$  is given by the algorithm B-to-B<sub>red</sub> in Figure 6. We use basically Gaussian elimination (i.e. multiplication by transvection matrices, cf. Proposition 1) on columns and rows of matrix  $\mathbf{B}$  to construct step by step the matrices  $\mathbf{A}$  and  $\mathbf{B}_{\text{red}}$  (see a complete example in Section 5.3).  $\square$

**Theorem 19.** *Any graph state  $|G\rangle$  can be written in the form*

$$|G\rangle = Z_{\mathbf{v}}X_{\mathbf{A}}Z_{\mathbf{B}_{\text{red}}}|+\rangle^{\otimes n}, \quad (67)$$

where  $\mathbf{v} \in \mathbb{F}_2^n$ ,  $\mathbf{A} \in \text{GL}_n(\mathbb{F}_2)$  is an upper triangular matrix and  $\mathbf{B}_{\text{red}}$  is a reduced matrix in  $\mathcal{B}_n$ .

*Proof.* Let  $|G\rangle = Z_{\mathbf{B}}\Omega|0\rangle^{\otimes n}$  be a graph state. Using lemma 18 we construct  $\mathbf{B}_{\text{red}}$  and  $\mathbf{A}$  such that  $\mathbf{B}_{\text{red}} = \mathbf{A}^t\mathbf{B}\mathbf{A}$ . Using Identity (36), one obtains  $X_{\mathbf{A}}Z_{\mathbf{B}_{\text{red}}}X_{\mathbf{A}}^{-1} = Z_{q_{\mathbf{B}_{\text{red}}}(\mathbf{A}^{-1})}Z_{\mathbf{A}^{-t}\mathbf{B}_{\text{red}}\mathbf{A}^{-1}}$ . Hence  $Z_{\mathbf{B}} = Z_{\mathbf{v}}X_{\mathbf{A}}Z_{\mathbf{B}_{\text{red}}}X_{\mathbf{A}}^{-1}$ , where  $\mathbf{v} = q_{\mathbf{B}_{\text{red}}}(\mathbf{A}^{-1})$ . So  $|G\rangle = Z_{\mathbf{v}}X_{\mathbf{A}}Z_{\mathbf{B}_{\text{red}}}X_{\mathbf{A}^{-1}}\Omega|0\rangle^{\otimes n}$ . Since Identity (42) holds, we obtain  $|G\rangle = Z_{\mathbf{v}}X_{\mathbf{A}}Z_{\mathbf{B}_{\text{red}}}\Omega X_{\mathbf{A}^t}|0\rangle^{\otimes n}$ . As a CNOT circuit has no effect on the ket  $|0\rangle^{\otimes n}$ , one has  $|G\rangle = Z_{\mathbf{v}}X_{\mathbf{A}}Z_{\mathbf{B}_{\text{red}}}\Omega|0\rangle^{\otimes n}$ .  $\square$

In Section 5.3, we provide a detailed example of the use of Theorem 19. Note that the CZ subcircuit in the form (67) has depth 1 and consequently all the CZ gates can be applied at the same time. This observation has a practical utility because the decoherence time remains currently an important technical concern in the experimental quantum computers.

```

ALGORITHM : Reduction of a matrix in  $\mathcal{B}_n$ .
INPUT :  $\mathbf{B}$ , a matrix in  $\mathcal{B}_n$ .
OUTPUT :  $(\mathbf{B}', \mathbf{A})$ , where
     $\mathbf{B}' \in \mathcal{B}_n$  is a reduced matrix congruent to  $\mathbf{B}$ ,
     $\mathbf{A} \in \text{GL}_n(\mathbb{F}_2)$  satisfies the congruence relation  $\mathbf{B}' = \mathbf{A}'\mathbf{B}\mathbf{A}$ .
1   $\mathbf{B}' \leftarrow \mathbf{B}; \mathbf{A} \leftarrow \mathbf{I};$ 
2  /* pivot[j] = true, if j has already been chosen as a pivot */
3  for j = 0 to n - 1 do
4      pivot[j]  $\leftarrow$  false;
5  for j = 0 to n - 2 do
6      if pivot[j] or card{ $i \mid b'_{ij} = 1$ } = 0 then
7          continue;
8      /* choosing pivot */
9       $p \leftarrow \min\{i \mid b'_{ij} = 1\};$ 
10     pivot[p]  $\leftarrow$  true;
11     /* Step a : eliminating the remaining 1's on column j and line j */
12     for r = p + 1 to n - 1 do
13         if  $b'_{rj} = 1$  then
14              $\mathbf{B}' \leftarrow [rp]\mathbf{B}'[pr];$ 
15              $\mathbf{A} \leftarrow \mathbf{A}[pr];$ 
16     /* Step b : eliminating the remaining 1's on line p and column p */
17     for c = j + 1 to n - 1 do
18         if  $b'_{pc} = 1$  then
19              $\mathbf{B}' \leftarrow [cj]\mathbf{B}'[jc];$ 
20              $\mathbf{A} \leftarrow \mathbf{A}[jc];$ 
21 return( $\mathbf{B}', \mathbf{A}$ );

```

**Figure 6:** Algorithm B-to-B<sub>red</sub>

The form (67) allows to implement a graph state  $|G\rangle = Z_{\mathbf{B}}\Omega|0\rangle^{\otimes n}$  in  $O\left(\frac{n^2}{\log(n)}\right)$  two-qubit gates by using the A-to-CNOT algorithm on the matrix  $\mathbf{A}$ . In this implementation, the two-qubit gate count is asymptotically better than the bound  $n(n-1)/2$  resulting from a basic implementation of the  $Z_{\mathbf{B}}$  operator. Whether or not this pre-treatment brings a real practical advantage depends, however, on the value of the constant  $c$  such that the two-qubit gate count remains lower than  $c\frac{n^2}{\log(n)}$ . In Table 1, we propose a few statistics in order to evaluate the usefulness of the form (67) in terms of reduction of the two-qubit gate count. This table was filled by using the command “./stabnf” in statistics mode. The source code of the command is available at <https://github.com/marcbataille/stabilizer-circuits-normal-forms>. We tested different samples of 200 random graph states, up to 300 qubits. The results show a clear superiority of the form  $|G\rangle = Z_{\mathbf{v}}X_{\mathbf{A}}Z_{\mathbf{B}_{\text{red}}}|+\rangle^{\otimes n}$  over the classical form  $|G\rangle = Z_{\mathbf{B}}|+\rangle^{\otimes n}$  in most samples. More precisely, let us define the *density*  $d$  of a graph state as being the quotient  $\frac{\ell}{n(n-1)/2}$ , where  $\ell$  is the number of edges and  $n$  the number of qubits. We observe that our method is efficient in all cases if the density of the graph state is greater than 0.6. For a graph state of small density



( $d \leq 0.2$ ), other methods have to be developed.

$n \backslash \ell$	$0.2 \times max$	$0.4 \times max$	$0.6 \times max$	$0.8 \times max$	$max = n(n-1)/2$
5	0%	0%	1%	21%	20%
10	0%	0%	20%	41%	33%
20	0%	0%	31%	49%	54%
50	0%	12%	41%	56%	62%
100	0%	23%	48%	61%	72%
200	0%	31%	54%	66%	74%
300	0%	37%	58%	68%	79%

Table 1: Gain obtained on the implementation of a graph state  $|G\rangle$  by using the form (67) ( $|G\rangle = Z_{\mathbf{v}} X_{\mathbf{A}} Z_{\mathbf{B}_{\text{red}}} |+\rangle^{\otimes n}$ ) instead of the form  $|G\rangle = Z_{\mathbf{B}} |+\rangle^{\otimes n}$ . In each cell  $(n, \ell)$  of the table, we computed the average two-qubit gate gain on a sample of 200 random graph states, where each graph has  $n$  vertices and  $\ell$  edges. Let  $\ell'$  be the number of two-qubit gates in the circuit implementing the form (67). The gain is defined as the difference  $\ell - \ell'$  if  $\ell > \ell'$  and 0 otherwise. It is expressed in percentage of  $\ell$ .

### 5.3 A complete example

We detail a complete example illustrating Theorem 19 and Algorithm B-to-B<sub>red</sub>. Let  $n = 7$  and  $|G\rangle = Z_{03} Z_{05} Z_{12} Z_{13} Z_{16} Z_{24} Z_{25} Z_{34} Z_{56} |+\rangle^{\otimes 7}$ .

$$\text{We have } |G\rangle = Z_{\mathbf{B}} |+\rangle^{\otimes 7}, \text{ where } \mathbf{B} = \begin{bmatrix} 0 & 0 & 0 & 1 & 0 & 1 & 0 \\ 0 & 0 & 1 & 1 & 0 & 0 & 1 \\ 0 & 1 & 0 & 0 & 1 & 1 & 0 \\ 1 & 1 & 0 & 0 & 1 & 0 & 0 \\ 0 & 0 & 1 & 1 & 0 & 0 & 0 \\ 1 & 0 & 1 & 0 & 0 & 0 & 1 \\ 0 & 1 & 0 & 0 & 0 & 1 & 0 \end{bmatrix}.$$

**Stage 1** : computing matrices  $\mathbf{A}$  and  $\mathbf{B}_{\text{red}}$ .

We apply Algorithm B-to-B<sub>red</sub> to the matrix  $\mathbf{B}$ .

After initializing each entry of the table *pivot* to false, we describe step by step the execution of the main loop (lines 5 to 20 in Figure 6).

$j = 0$  Choosing pivot :  $p \leftarrow 3$ ; pivot[3]  $\leftarrow$  true;

$$\text{Step a : } [53]\mathbf{B}[35] = \begin{bmatrix} \mathbf{0} & \mathbf{0} & \mathbf{0} & \mathbf{1} & \mathbf{0} & \mathbf{0} & \mathbf{0} \\ \mathbf{0} & \mathbf{0} & \mathbf{1} & \mathbf{1} & \mathbf{0} & \mathbf{1} & \mathbf{1} \\ \mathbf{0} & \mathbf{1} & \mathbf{0} & \mathbf{0} & \mathbf{1} & \mathbf{1} & \mathbf{0} \\ \mathbf{1} & \mathbf{1} & \mathbf{0} & \mathbf{0} & \mathbf{1} & \mathbf{0} & \mathbf{0} \\ \mathbf{0} & \mathbf{0} & \mathbf{1} & \mathbf{1} & \mathbf{0} & \mathbf{1} & \mathbf{0} \\ \mathbf{0} & \mathbf{1} & \mathbf{1} & \mathbf{0} & \mathbf{1} & \mathbf{0} & \mathbf{1} \\ \mathbf{0} & \mathbf{1} & \mathbf{0} & \mathbf{0} & \mathbf{0} & \mathbf{1} & \mathbf{0} \end{bmatrix}$$

$$\text{Step b : } [40][10][53]\mathbf{B}[35][01][04] = \begin{bmatrix} 0 & 0 & 0 & 1 & 0 & 0 & 0 \\ 0 & 0 & 1 & 0 & 0 & 1 & 1 \\ 0 & 1 & 0 & 0 & 1 & 1 & 0 \\ 1 & 0 & 0 & 0 & 0 & 0 & 0 \\ 0 & 0 & 1 & 0 & 0 & 1 & 0 \\ 0 & 1 & 1 & 0 & 1 & 0 & 1 \\ 0 & 1 & 0 & 0 & 0 & 1 & 0 \end{bmatrix}$$

$j = 1$  Choosing pivot :  $p \leftarrow 2$ ; pivot[2]  $\leftarrow$  true;

$$\text{Step a : } [62][52][40][10][53]\mathbf{B}[35][01][04][25][26] = \begin{bmatrix} 0 & 0 & 0 & 1 & 0 & 0 & 0 \\ 0 & 0 & 1 & 0 & 0 & 0 & 0 \\ 0 & 1 & 0 & 0 & 1 & 1 & 0 \\ 1 & 0 & 0 & 0 & 0 & 0 & 0 \\ 0 & 0 & 1 & 0 & 0 & 0 & 1 \\ 0 & 0 & 1 & 0 & 0 & 0 & 0 \\ 0 & 0 & 0 & 0 & 1 & 0 & 0 \end{bmatrix}$$

$$\text{Step b : } [51][41][62][52][40][10][53]\mathbf{B}[35][01][04][25][26][14][15] = \begin{bmatrix} 0 & 0 & 0 & 1 & 0 & 0 & 0 \\ 0 & 0 & 1 & 0 & 0 & 0 & 0 \\ 0 & 1 & 0 & 0 & 0 & 0 & 0 \\ 1 & 0 & 0 & 0 & 0 & 0 & 0 \\ 0 & 0 & 0 & 0 & 0 & 0 & 1 \\ 0 & 0 & 0 & 0 & 0 & 0 & 0 \\ 0 & 0 & 0 & 0 & 1 & 0 & 0 \end{bmatrix}$$

$j = 2$  pivot[2] = true, so continue

$j = 3$  pivot[3] = true, so continue

$j = 4$  Choosing pivot :  $p \leftarrow 6$ ; pivot[6]  $\leftarrow$  true;

Step a :  $\mathbf{B}'$  remains unchanged

Step b :  $\mathbf{B}'$  remains unchanged

$j = 5$  null column, so continue

return( $\mathbf{B}'$ ,  $\mathbf{A}$ ), where

$$\mathbf{B}' = \mathbf{B}_{\text{red}} = \begin{bmatrix} 0 & 0 & 0 & 1 & 0 & 0 & 0 \\ 0 & 0 & 1 & 0 & 0 & 0 & 0 \\ 0 & 1 & 0 & 0 & 0 & 0 & 0 \\ 1 & 0 & 0 & 0 & 0 & 0 & 0 \\ 0 & 0 & 0 & 0 & 0 & 0 & 1 \\ 0 & 0 & 0 & 0 & 0 & 0 & 0 \\ 0 & 0 & 0 & 0 & 1 & 0 & 0 \end{bmatrix},$$

$$\text{and } \mathbf{A} = [35][01][04][25][26][14][15] = \begin{bmatrix} 1 & 1 & 0 & 0 & 0 & 1 & 0 \\ 0 & 1 & 0 & 0 & 1 & 1 & 0 \\ 0 & 0 & 1 & 0 & 0 & 1 & 1 \\ 0 & 0 & 0 & 1 & 0 & 1 & 0 \\ 0 & 0 & 0 & 0 & 1 & 0 & 0 \\ 0 & 0 & 0 & 0 & 0 & 1 & 0 \\ 0 & 0 & 0 & 0 & 0 & 0 & 1 \end{bmatrix}.$$

**Stage 2** : computing the Pauli part  $Z_{\mathbf{v}}$ , where  $\mathbf{v} = q_{\mathbf{B}_{\text{red}}}(\mathbf{A}^{-1})$ .

The quadratic form  $q_{\mathbf{B}_{\text{red}}}$  is defined by :

$$q_{\mathbf{B}_{\text{red}}}([x_0, x_1, x_2, x_3, x_4, x_5, x_6]^t) = x_0x_3 \oplus x_1x_2 \oplus x_4x_6,$$

$$\text{and } \mathbf{A}^{-1} = [15][14][26][25][04][01][35] = \begin{bmatrix} 1 & 1 & 0 & 0 & 1 & 0 & 0 \\ 0 & 1 & 0 & 0 & 1 & 1 & 0 \\ 0 & 0 & 1 & 0 & 0 & 1 & 1 \\ 0 & 0 & 0 & 1 & 0 & 1 & 0 \\ 0 & 0 & 0 & 0 & 1 & 0 & 0 \\ 0 & 0 & 0 & 0 & 0 & 1 & 0 \\ 0 & 0 & 0 & 0 & 0 & 0 & 1 \end{bmatrix}.$$

Hence  $q_{\mathbf{B}_{\text{red}}}(\mathbf{A}^{-1}) = [0, 0, 0, 0, 0, 1, 0]^t$ , so  $Z_{\mathbf{v}} = Z_5$ .

**Stage 3**: applying the **A-to-CNOT** algorithm to matrix  $\mathbf{A}$ .

This yields  $\mathbf{A} = [35][25][26][14][01][15]$ .

**Stage 4** : conclusion.

We deduced that  $|G\rangle = Z_5X_{35}X_{25}X_{26}X_{14}X_{01}X_{15}Z_{03}Z_{12}Z_{46}|+\rangle^{\otimes 7}$

## 5.4 Implementation of graph states in the IBM quantum computers

We deal with the case of a concrete implementation of graph states in a real-life quantum machine. Our intention is to show the practical usefulness that can have a pretreatment of the circuit based on Theorem 19, in terms of reduction of the *native* gate count in the *compiled* circuit. We implemented in the publicly available 5-qubit `ibmq_belem` device (<https://quantum-computing.ibm.com/>) the complete graph state

$$|K_5\rangle = Z_{01}Z_{02}Z_{03}Z_{04}Z_{12}Z_{13}Z_{14}Z_{23}Z_{24}Z_{34}|+\rangle^{\otimes 5}. \quad (68)$$

This graph-state is of particular interest because it is LC (Local Clifford) equivalent, and thus SLOCC equivalent, to the entangled state  $|\text{GHZ}\rangle_5 = \frac{1}{\sqrt{2}}(|00000\rangle + |11111\rangle)$  (see [8] for the first introduction of the  $|\text{GHZ}\rangle$  state and [9, Section 4.1] for a proof of the equivalence). To write  $|K_5\rangle$  in the form (67), we simply use our command `./stbnf` in manual mode and obtain :

$$|K_5\rangle = Z_2Z_3X_{34}X_{23}X_{12}X_{02}X_{24}X_{23}Z_{01}Z_{23}|+\rangle^{\otimes 5}. \quad (69)$$

Observe that the form 69 contains only 8 two-qubit gates comparing to the 10 CZ gates of the form 68, which is a substantial reduction of 20%. But what about the

reduction if we consider the circuit, consisting exclusively of native gates, that is actually implemented in the quantum computer ? Is it still significant ? In the IBM quantum devices, the CZ gate is not native and is simulated thanks to Identity (14). The Hadamard gate is implemented from the  $R_z(\pi/2)$  and  $\sqrt{X}$  gates, since

$$H = e^{i\frac{\pi}{4}} R_z(\pi/2) \sqrt{X} R_z(\pi/2), \text{ where } \sqrt{X} = \frac{1}{2} \begin{bmatrix} 1+i & 1-i \\ 1-i & 1+i \end{bmatrix} \text{ and } R_z(\theta) = \begin{bmatrix} e^{-i\frac{\theta}{2}} & 0 \\ 0 & e^{i\frac{\theta}{2}} \end{bmatrix}.$$

Moreover full connectivity is not achieved and the direct connections allowed between two qubits are given by a graph. The graph of the 5-qubit ibmq\_belem device is  $\{\{1, 0\}, \{1, 2\}, \{1, 3\}, \{3, 4\}\}$ . So, to implement a CNOT gate between qubits without direct connection (*e.g.* qubits 2 and 3), it is necessary to simulate it from the native CNOT gates using methods we described in a previous work [2, Section 3]. Due to its similarities to the compilation process in classical computing, the rewriting process that transforms an input circuit with measurements into a native gate circuit giving statistically the same measurement results, is called *transpilation* on the IBM quantum computing website.

The quantum circuits below were produced using the publicly available IBM Quantum Composer <https://quantum-computing.ibm.com/>. First, we present the circuits (before and after transpilation) in the case of an implementation of  $|K_5\rangle$  corresponding to the form 68.

$$\text{INPUT : } |K_5\rangle = Z_B |+\rangle^{\otimes 5} = Z_{01} Z_{02} Z_{03} Z_{04} Z_{12} Z_{13} Z_{14} Z_{23} Z_{24} Z_{34} |+\rangle^{\otimes 5}$$

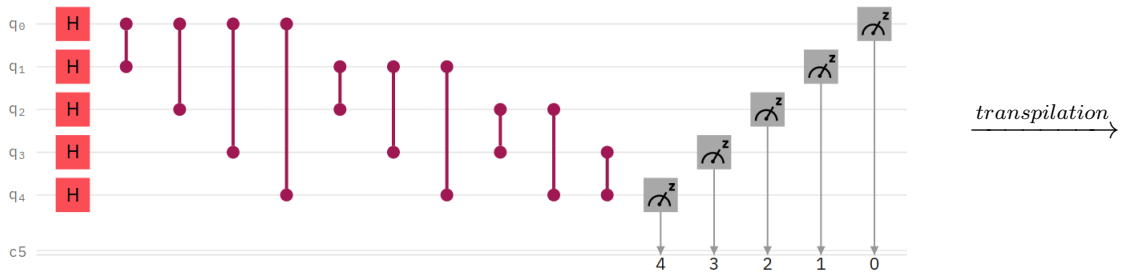

OUTPUT :

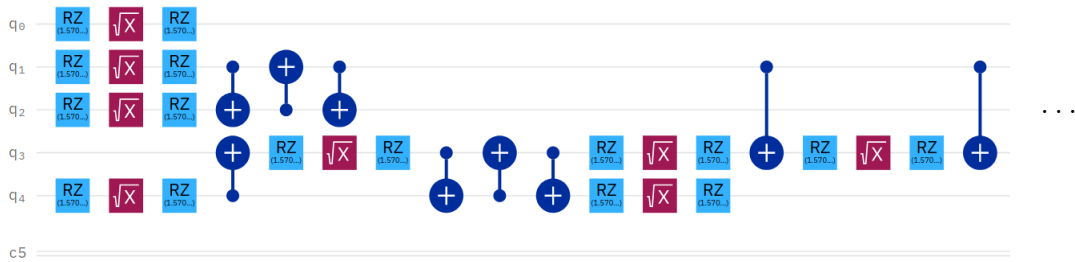

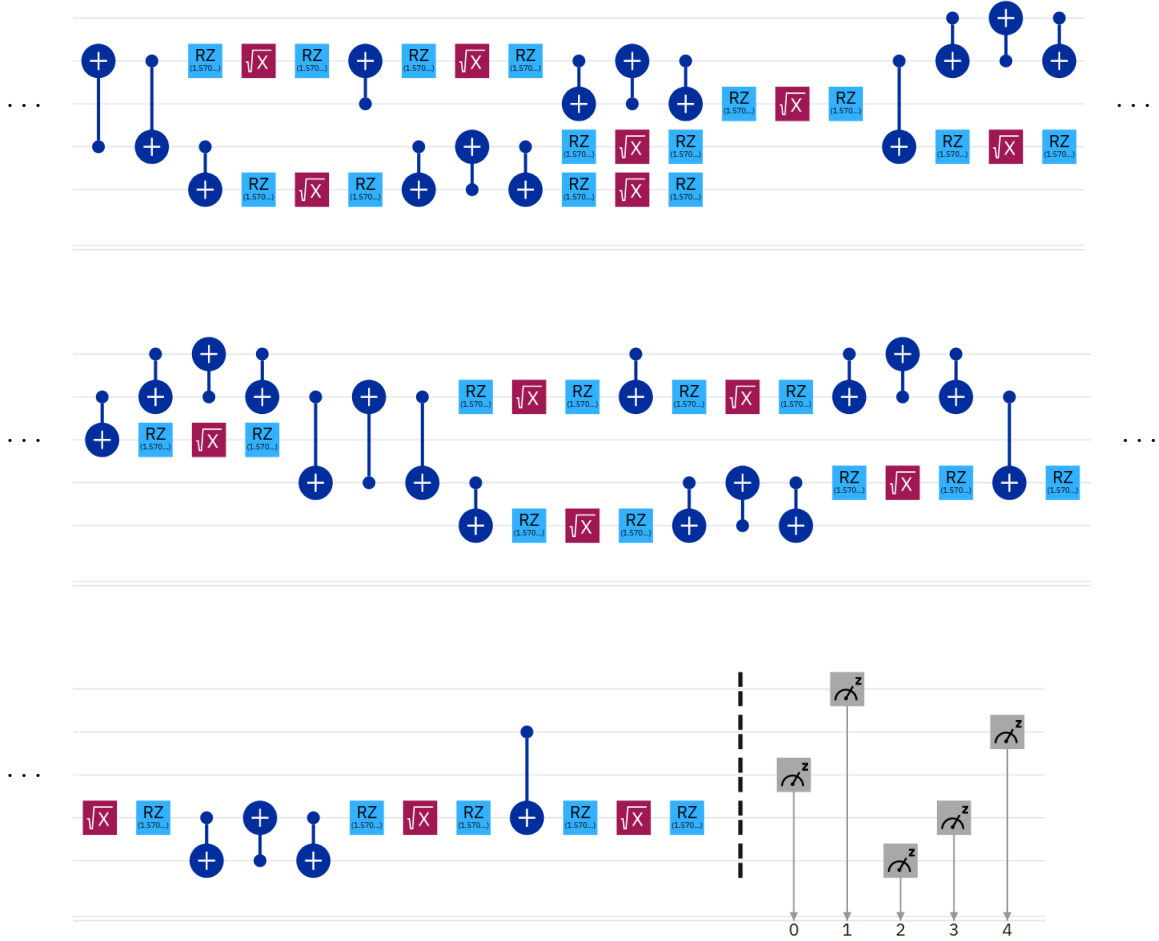

We remark that the transpiled circuit based on the form 68 contains 43 CNOT gates and 69 single qubit gates.

Then, we show the circuits (before and after transpilation) implementing the same graph state  $|K_5\rangle$  written in the form 69.

$$\text{INPUT : } |K_5\rangle = Z_{\mathbf{v}} X_{\mathbf{A}} Z_{B_{\text{red}}} |+\rangle^{\otimes 5} = Z_2 Z_3 X_{34} X_{23} X_{12} X_{02} X_{24} X_{23} Z_{01} Z_{23} |+\rangle^{\otimes 5}$$

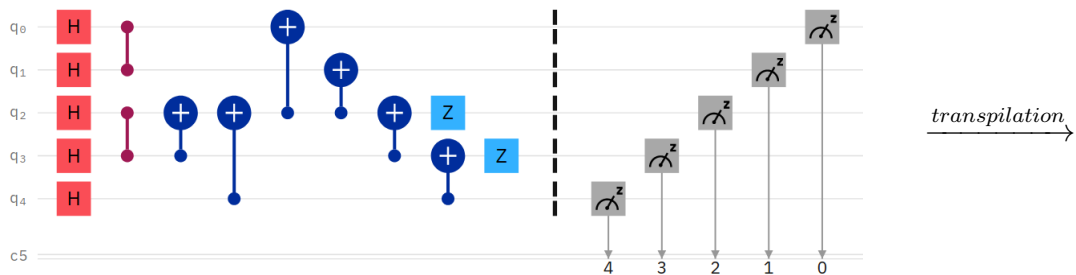

OUTPUT :

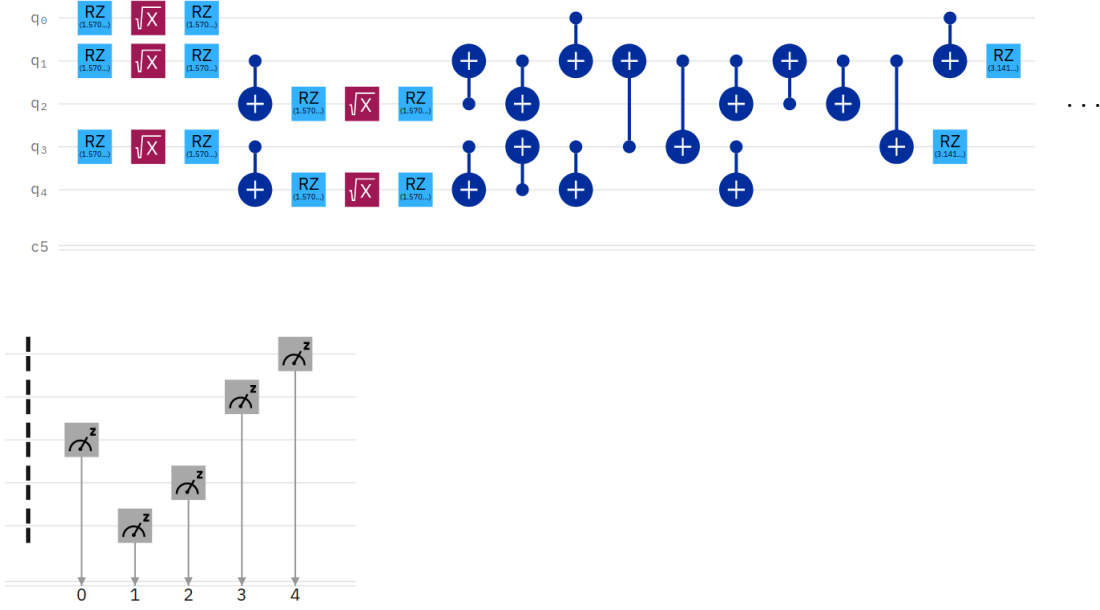

In this case, the transpiled circuit contains only 16 CNOT gates and 17 single gates. So, using our method, we obtain a reduction of 63% of the two-qubit gate count, comparing to the naive implementation based on the form 69.

Implementation in the 5-qubit ibmq_belem device					
Ref.	INPUT			OUTPUT	
	Circuit	Count	Gain	Count	Gain
1(a)	$Z_{01}Z_{02}Z_{03}Z_{04}Z_{12}Z_{13}Z_{14}Z_{23}Z_{24}Z_{34}  +\rangle^{\otimes 5}$	10	20%	43	63%
1(b)	$Z_2Z_3X_{34}X_{23}X_{12}X_{02}X_{24}X_{23}Z_{01}Z_{23}  +\rangle^{\otimes 5}$	8		16	
2(a)	$Z_{02}Z_{03}Z_{04}Z_{13}Z_{14}Z_{23}Z_{24}Z_{34}  +\rangle^{\otimes 5}$	8	25%	26	19%
2(b)	$Z_3X_{34}X_{23}X_{14}X_{03}Z_{02}Z_{13}  +\rangle^{\otimes 5}$	6		21	
3(a)	$Z_{01}Z_{02}Z_{03}Z_{04}Z_{12}Z_{13}Z_{23}Z_{24}  +\rangle^{\otimes 5}$	8	0%	35	40%
3(b)	$Z_2Z_3X_{23}X_{24}X_{12}X_{02}X_{04}X_{23}Z_{01}Z_{23}  +\rangle^{\otimes 5}$	8		21	
4(a)	$Z_{01}Z_{02}Z_{04}Z_{12}Z_{13}Z_{23}Z_{34}  +\rangle^{\otimes 5}$	7	14%	28	32%
4(b)	$Z_2X_{12}X_{02}X_{14}X_{03}Z_{01}Z_{24}  +\rangle^{\otimes 5}$	6		19	
Implementation in the 15-qubit ibmq_melbourne device					
5(a)	$Z_{02}Z_{03}Z_{04}Z_{13}Z_{14}Z_{15}Z_{23}Z_{25}Z_{26}Z_{34}Z_{35}Z_{45}Z_{46}Z_{56}  +\rangle^{\otimes 7}$	14	21%	41	22%
5(b)	$Z_3X_{34}X_{23}X_{35}X_{16}X_{06}X_{04}X_{03}Z_{02}Z_{13}Z_{46}  +\rangle^{\otimes 7}$	11		32	
6(a)	$Z_{03}Z_{05}Z_{12}Z_{13}Z_{16}Z_{24}Z_{25}Z_{34}Z_{56}  +\rangle^{\otimes 7}$	9	0%	33	18%
6(b)	$Z_5X_{35}X_{25}X_{26}X_{14}X_{01}X_{15}Z_{03}Z_{12}Z_{46}  +\rangle^{\otimes 7}$	9		27	

Table 2: Implementation of graph states in two publicly available quantum computers. Gains obtained by form (b) :  $Z_{\mathbf{v}}X_{\mathbf{A}}Z_{\mathbf{B}_{\text{red}}}|+\rangle^{\otimes n}$  over form (a) :  $Z_{\mathbf{B}}|+\rangle^{\otimes n}$  (two-qubit gate count) before transpilation (INPUT) and after transpilation (OUTPUT).

In Table 2, we present the gains obtained, before and after transpilation, by using

the form  $Z_{\mathbf{v}}X_{\mathbf{A}}Z_{\mathbf{B}_{\text{red}}}|+\rangle^{\otimes n}$  of a few 5-qubit graph states (in the 5-qubit `ibmq_belem` device) and 7-qubit graph states (in the 15-qubit `ibmq_melbourne` device). Again, we observe a significant gain on the transpiled circuit. Moreover the gain after transpilation is often higher than the gain before transpilation. Roughly, this is due to hardware reasons (graph of the qubit network, native gates) and to software reasons (how the compiler works) but this observation deserves certainly further analysis. Actually, a complete analysis should take in account the detailed technical specifications of the device as well as the source code of the compiler, which is beyond the scope of this paper. Although our experiment is based on a few circuits implemented in some particular quantum computers, the results indicate that Theorem 19 can have practical useful applications, which was our initial purpose.

## 6 Conclusion and future work

Gottesman proved in his PhD thesis that any unitary matrix in the Clifford group is uniquely defined, up to a global phase, by its action by conjugation on the Pauli gates  $X_i$  and  $Z_i$  [7, pp.41,42]. This central statement of Gottesman stabilizer formalism can be used to compute normal forms for  $n$ -qubit stabilizer circuits via the symplectic group over  $\mathbb{F}_2$  in dimension  $2n$  (e.g. [1, 10]). In this paper we showed that it is possible to compute normal forms in polynomial time without using this formalism. We proposed a new method based on induction and on simple conjugation rules in the Clifford group. The reader who is used to work with the symplectic group will notice that our induction process can also be applied inside this group, giving rise to a decomposition of type  $\mathbf{M}_{\sigma} \begin{bmatrix} \mathbf{I} & \mathbf{D} \\ \mathbf{0} & \mathbf{I} \end{bmatrix} \begin{bmatrix} \mathbf{I} & \mathbf{0} \\ \mathbf{B} & \mathbf{I} \end{bmatrix} \begin{bmatrix} \mathbf{A} & \mathbf{0} \\ \mathbf{0} & \mathbf{A}^{-t} \end{bmatrix}$  for the symplectic matrix associated to the GenPZX form, where  $\mathbf{B}$  (resp.  $\mathbf{D}$ ) is a symmetric matrix corresponding to  $P_{\mathbf{b}}Z_{\mathbf{B}}$  (resp.  $P_{\mathbf{d}}Z_{\mathbf{D}}$ ),  $\mathbf{A} \in \text{GL}_n(\mathbb{F}_2)$  is the invertible matrix corresponding to the CNOT sub-circuit  $X_{\mathbf{A}}$ , and  $\mathbf{M}_{\sigma}$  is a permutation matrix in dimension  $2n$  corresponding to a circuit of Hadamard gates.

In the NISQ era (Noisy Intermediate-Scale Quantum), noise in quantum gates strongly limits the reliability of quantum circuits and is currently a major technical concern. Developing optimization algorithms and heuristics to reduce the gate count in circuits is one of the solutions to improve reliability. In this article, we proposed algorithms to reduce circuits implementing an important class of quantum states, namely the graph states, which are local Clifford equivalent to stabilizer states. We realised a few experimental tests on quantum computers that highlight the utility of a pretreatment based on our algorithms to reduce the gate count in the compiled circuit implementing a graph state. We believe that the field of quantum circuits compilation is yet in its infancy but it will play an increasing significant role due to the current quick development of experimental quantum computers. We will continue to investigate reduction techniques related to the compilation of quantum circuits in future works.

## 7 Acknowledgements

The author acknowledges the use of the IBM Quantum Experience <https://quantum-computing.ibm.com/>. The views expressed are those of the author and do not reflect the official policy or position of IBM or the IBM Quantum Experience team.

## References

- [1] Scott Aaronson and Daniel Gottesman. Improved simulation of stabilizer circuits. *Physical Review A*, 70(5), Nov 2004.
- [2] Marc Bataille. Quantum circuits of CNOT gates, 2020. arXiv:2009.13247.
- [3] Marc Bataille and Jean-Gabriel Luque. Quantum circuits of cZ and SWAP gates: optimization and entanglement. *Journal of Physics A: Mathematical and Theoretical*, 52(32):325302, jul 2019.
- [4] Sergey Bravyi and Dmitri Maslov. Hadamard-free circuits expose the structure of the clifford group, 2020. arXiv:2003.09412.
- [5] A. R. Calderbank, E. M. Rains, P. M. Shor, and N. J. A. Sloane. Quantum error correction via codes over GF(4). *IEEE Transactions on Information Theory*, 44(4):1369–1387, 1998.
- [6] Ross Duncan, Aleks Kissinger, Simon Perdrix, and John van de Wetering. Graph-theoretic simplification of quantum circuits with the zx-calculus. *Quantum*, 4:279, Jun 2020.
- [7] Daniel Gottesman. *Stabilizer Codes and Quantum Error Correction*. PhD thesis, California Institute of Technology, Pasadena, CA, 1997.
- [8] Daniel M. Greenberger, Michael A. Horne, and Anton Zeilinger. Bell’s theorem without inequalities. *American Journal of Physics*, 58 (12):1131, 1990.
- [9] M. Hein, W. Dür, J. Eisert, R. Raussendorf, M. Van den Nest, and H. J. Briegel. Entanglement in Graph States and its Applications. *arXiv e-prints*, pages quant-ph/0602096, February 2006.
- [10] Dmitri Maslov and Martin Roetteler. Shorter stabilizer circuits via bruhat decomposition and quantum circuit transformations. *IEEE Transactions on Information Theory*, 64(7):4729–4738, Jul 2018.
- [11] Michael A. Nielsen and Isaac L. Chuang. *Quantum Computation and Quantum Information: 10th Anniversary Edition*. Cambridge University Press, New York, NY, USA, 10th edition, 2011.
- [12] Ketan Patel, Igor Markov, and John Hayes. Optimal synthesis of linear reversible circuits. *Quantum Information and Computation*, 8, 05 2004.



- [13] Maarten Van den Nest, Jeroen Dehaene, and Bart De Moor. Graphical description of the action of local clifford transformations on graph states. *Physical Review A*, 69(2), Feb 2004.