

RESEARCH

Convolutional Neural Networks Based System for Urban Sound Tagging with Spatiotemporal Context

Jisheng Bai, Jianfeng Chen, Mou Wang and Xiaolei Zhang

Abstract

Noise pollution has a significant impact on the quality of life of citizens and urban development, and its prevention and control has been widely valued. In order to better protect the environment, the analysis and monitoring technology of urban noise pollution needs to be further optimized. Urban Sound Tagging (UST) can help to map the distribution of noise pollution and therefore attracts more attentions. The goal of UST is to tag a recording, which is collected by the sensors from urban environment, and returns whether noise pollution is audible or not. In previous works, only sound signal is provided and used. However, the spatiotemporal context can offer more information. In this paper, we proposed convolutional neural networks (CNNs) based system for UST with spatiotemporal context. In our system, multiple features and spatiotemporal context are combined, and fed into a residual CNN to predict whether noise of pollution is present in a 10-second recording. To eliminate the imbalance problem of the dataset, a data augmentation method is applied during the training. Finally, a fusion strategy is adopted to further improve the performance of UST. We evaluated the proposed system on the DCASE2020 task5 dataset. The experimental results show that the proposed system significantly outperform the baseline system on the evaluation metrics.

Keywords: Urban Sound Tagging; Convolutional neural networks; Spatiotemporal context; Multiple features

1 Introduction

Based on intelligent technologies, making city smarter has become a trend in various countries. Smart city aims to improve the level of urbanization, the comfort of residents and intelligence of public transport. However, the development of smart city can cause some problems which affect the citizen's life. Among the environmental pollutants, awareness regarding noise pollution is relatively weak. The exposure to noise pollution has exceeded the acceptable level in some EU countries [1].

Noise pollution is one of the topmost quality-of-life concerns for urban residents [2]. It has been proved that the exposure under noise can cause sleep disruption, heart disease and hearing loss, even learning and cognitive impairment in children [3]. Noise pollution have effects on human life, economy and society. For public health and improving living condition against noise pollution in cities, to detect and monitor the distribution of noise is essential [4]. A lot of solutions have been proposed in some previous research projects, which seek to improve the ability of monitoring urban

noise [5, 6]. To analysis noise pollution in a fine-level, machine listening can help to distinguish urban noise sources on noise maps.

Generally speaking, the purpose of machine listening is to use signal processing and machine learning methods to recognize sound automatically, which is very similar to the process of speech recognition. An important technique in the development of machine listening is called automatic sound recognition (ASR). At first, the application of ASR focused on content-based audio retrieval and classification [7], speech and non speech recognition. After that, it is simplified into music type classification [8] and musical instrument sound classification [9]. Plenty of realistic applications successfully implement ASR techniques like wearable devices [10] and audio-surveillance systems [11].

Environmental sound recognition (ESR) is an important part of ASR and a key in the development of machine listening. ASR in environmental sound has attracted a lot of attention in recent years in bird sound detection [12], sound event localization and detection and sound tagging [13]. The challenge which makes ESR more complex than music and speech recogni-

tion is that environmental sound behaves in a variable fashion [14] and changes rapidly, and we lack of much expertise of processing environmental sound.

To address the challenges in urban environment, a task in ESR named UST is presented. The goal of UST is to predict whether some noise pollution is present or absent in a recording. A developed UST system can extract meaningful information from urban sound while monitoring the noise pollution. It has been one important task in the Challenge on Detection and Classification of Acoustic Scenes and Events (DCASE) [15]. Meanwhile, some of the successful techniques in the UST could inspire the development of an embedded solution for low-cost and scalable monitoring, analysis, and mitigation of urban noise.

A UST system usually consists of acoustic features extraction and classifiers. In early works, the classifiers are commonly based on machine learning techniques, such as Gaussian mixtures models (GMMs) [16], hidden Markov models (HMMs) [17], support vector machines [18] and neural networks [19]. Then, the appearance of graphics processing units (GPUs) makes deep learning develop rapidly. Hence, training a deep neural network is feasible with the popularization of GPUs in recent years. Deep neural networks with special structures such as CNNs and recurrent neural networks (RNNs) have been widely used in some classical pattern recognition tasks. Due to the capability of feature extraction, CNNs have been one of the state-of-the-art classifiers in sound tagging systems [20–22].

To explore audio signals in both time and frequency dimensions, we employ time-frequency representations as common acoustic features in our UST system. A higher dimensional feature can obtain a local feature that can not be reflected in one dimension. For the sound signal, people rely on the three characteristics of timbre, pitch and volume to distinguish. In speech recognition, these features can be determined by the parameters in the time-frequency structure of the spectrogram, such as formant, harmonic, pitch and transient. The auditory patterns can be commonly described as an image, and the use of convolution on image is helpful for improving the dimension of feature extraction. Hence, this motivates researchers to convert an audio signal into an auditory image. For feature extraction, various time-frequency domain based features have been applied, including short-time Fourier transform (STFT), harmonic and percussive separation (HPSS) and Mel-frequency cepstral coefficients. Moreover, audio embeddings such as OpenL3 [23] and VGGish [24, 25] are used as encoded audio representations in some ASR tasks [26]. Specially, spectrogram with Mel-frequency filter banks has been a main feature in DCASE challenges [27, 28].

In most scenarios, the spatiotemporal context metadata can offer more information for UST. The spatial context can provide the location information of a sound, and the temporal context can provide the time of a sound. For example, an excavator is more possible to appear in a building site rather than a park, and the noise of the excavator should not be heard at night. Nevertheless, to the best of our knowledge, the spatiotemporal context have rarely been used in previous works about UST.

In this paper, we propose a CNN based system for detecting urban sound with spatiotemporal context. Specially, a data augmentation method, i.e. mixup, is applied to overcome imbalance of the dataset and overfitting of the system. To explore features of various sources of sound, we extract log-Mel spectrogram, log-linear spectrogram, HPSS from the audio. Then, the features are fed into residual block based CNNs models with the vectors encoded from the spatiotemporal context. To take advantages of different features and data augmentation methods, we make a fusion to further improve the performance. The contributions of this paper lie in the following four aspects:

- Spatiotemporal context can offer complementary information that may help tag urban sound, however, previous studies in UST are short of utilizing the spatiotemporal context. Therefore, the spatiotemporal context is introduced into our UST system and three methods of encoding spatiotemporal context are experimented.
- Different acoustic features (log-Mel, log-linear and HPSS spectrograms) are extracted to explore the performance of recognizing a variety of sound sources in urban environment.
- Based on the advantages of acoustic features and CNNs for tagging urban sound, an ensemble method is employed to improve the performance of the system.
- The proposed methods are evaluated on the latest dataset of DCASE2020.

The rest paper is organized as follows. Section 2 introduces some important literatures regarding deep learning and feature extraction in ESR and UST. Section 3 describes the proposed methods. Section 4 provides the detailed experimental settings. In Section 5, we present the results of experiments, and some interesting results will be discussed. Section 6 concludes this paper.

2 Related work

In the works related to ASR, speech and music recognition have been primarily studied over the years. However, research in ESR has significantly attracted more interest in the last decade [29]. Environmental sounds

include both indoor and outdoor sounds, and some techniques in ESR have been successfully applied in these circumstances [30, 31]. Environmental sounds tagging is to analyse the environment that people are living [32]. The study of urban sound tagging or classification is meaningful to citizens and the construction of smart city.

The methodologies in UST involving the use of acoustic features are modelled through the extraction of distinguishable auditory patterns, and machine learning algorithms are pivotal to achieve impressive classification performance. According to Cowling and Sitte [33], features extraction can be simply divided into stationary and non-stationary feature extraction. Stationary feature extraction produces an overall information of a signal, but it cannot recognize where these frequencies are available in the signal [34]. In contrast, non-stationary feature extraction splits the signal into discrete time units and aids us to understand the characteristic of the signal. The auditory features used in ESR and UST is usually Mel-Frequency Cepstral Coefficients (MFCCs) [35, 36], but such traditional feature has been proved to be sensitive to noise presented in an urban environment [37]. Auditory-image based features plays a vital role in ESR tasks, and the time-frequency representations are often extracted from a spectrogram. Chu et al. [18] proposed matching pursuit (MP) based features to yield higher recognition accuracy for environmental sounds. The commonly used features such as Gabor filter bank features [38] and spectrogram image features [39] also achieved leading performances for ESR tasks. The utilization of Mel-scale spectrogram have been proven to be useful and performed the state-of-the-art in related tasks [19, 40, 41]. Mel spectrogram combined

with Chromagram, Tempogram, MFCC, Contrast and Tonnetz are used for music recognition [42] and a CNN with mixed Log-Mel and Gammatone spectrograms is proposed for environment sounds classification [43]. Recently, the authors [44] extracted different types of audio images (spectrograms, harmonic and percussion images, and ScatNet scattering representations) to classify animals, and Yu Su et al. experimented a aggregated feature and achieved the state-of-the-art classification accuracy in ESR tasks. Moreover, a multi-feature fusion based method showed a leading performance for UST [45].

Besides the feature extraction, another critical stage of UST is the choose of classifier. Deep learning techniques have outperformed some of the ordinary classifiers (GMMs, HMMs and SVM) since the past decade. Due to the strong ability of extracting features, CNNs have been one of the most salient structures. The convolution operations in CNNs are able to improve the dimensions of feature and catch time-frequency patterns of a image-based auditory representation. Experimental results showed that CNN models could achieve a remarkable performance in ESR tasks [25, 46]. In addition, an extension version of CNN named residual network (ResNet) was applied in [47], and mixup, a data augmentation method, was introduced in [43], both of them yielded excellent performances.

3 Proposed Method

The overall architecture of the proposed UST system is given in Fig. 1. It consists of four modules: feature extractor, CNNs, spatiotemporal context encoder and model fusion. Firstly, we extract four types of acoustic feature, i.e. log-Mel, log-linear, harmonic and percussive spectrograms from each recording. Then the

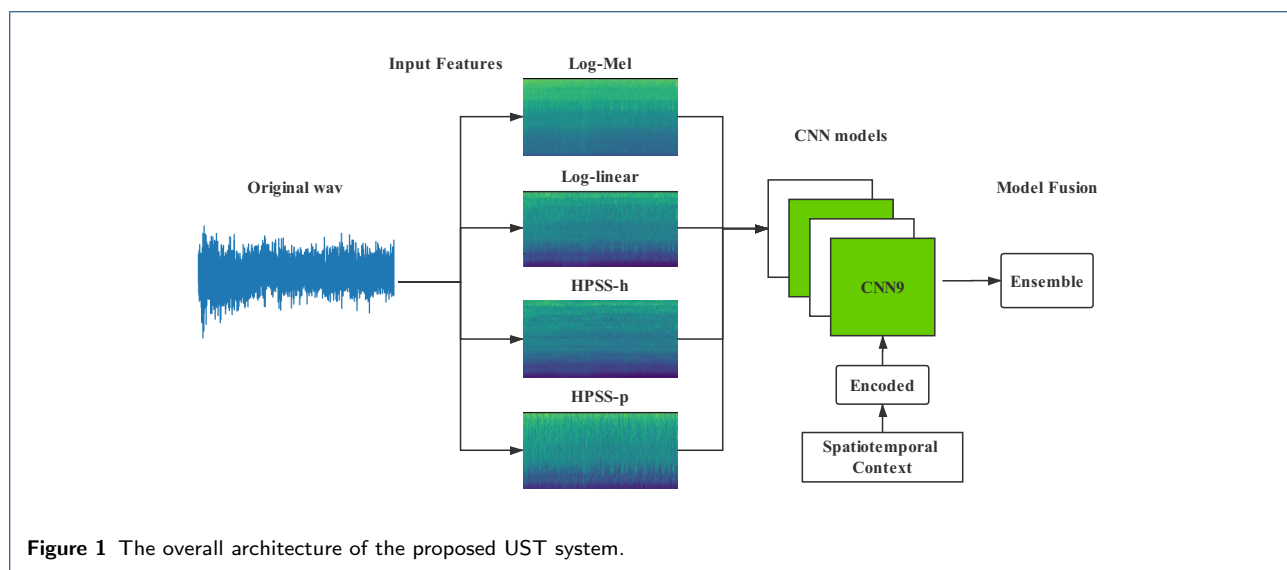

Figure 1 The overall architecture of the proposed UST system.

features are fed into a 9-layer CNN with or without a residual block, respectively. Meanwhile, the spatiotemporal context is encoded into a vector, which is concatenated with the features derived from CNN, and the concatenated vector is fed into the classification layer. During model training, a data augmentation method, i.e. mixup, is applied to generate new samples and overcome the problem of imbalanced dataset. Finally, model fusion is adopted to further improve the performance.

3.1 Features Extraction

Log-Mel spectrogram has been the most popular feature and suitable for sound tagging [48] due to the characteristics of Mel scale. Mel scale is inspired by the perceptual patterns in human auditory system, and the mapping from linear frequency to Mel frequency is shown in Eq. 1:

$$f_{Mel} = 2595 \cdot \lg \left(1 + \frac{f}{700} \right) \quad (1)$$

where f is the frequency. But the resolution of Mel filter banks in higher frequencies is relative low [49]. To investigate whether higher resolution in higher frequencies is helpful for tagging urban sounds, linear filter banks are applied as well. The recordings are firstly converted into time-frequency spectrograms using the STFT. After that, Mel filter banks are applied on each frame to transform linear spectrum to Mel scale, and linear filter banks are used to get linear spectrograms. Finally, we calculate log-Mel spectrograms and log-linear spectrograms by applying logarithm.

A sound signal can be decomposed into harmonic part and percussive part, which can provide the information from different aspects. We separate the spectrogram of each recording into harmonic part and percussive part with HPSS algorithm [50, 51]. To take forementioned advantages of Mel scale, the harmonic and percussive spectrograms which are extracted from the original spectrograms, are filtered by Mel filter banks. Similarly, the logarithm is used on HPSS spectrograms. In this paper, the harmonic and percussive spectrograms filtered by Mel filter banks are denoted as **HPSS-h** and **HPSS-p**, respectively.

3.2 Convolutional Neural Networks

The CNN architecture of our proposed system is similar to the VGGNet. It consists of 4 convolutional blocks, each of which consists of two convolutional layers with a kernel size of 3×3 , and the number of convolutional filters is the same inside each block. After each convolutional block, an average pooling layer is implemented to reduce the size of feature maps. The

TimeDistributed layers and AutoPool layer are used for classification at the end of the model. Thus, there are 9 layers in the proposed system in total, and we denote the model as **CNN9**. Moreover, batch normalization [52] is applied to speed up and prevent overfitting during train steps. After batch normalization, leaky_ReLU is used as a non-linear activation. The detailed architecture and parameter settings of the CNN are presented in Table 1.

Table 1 Architecture of the 9-layer CNN. Conv-block means convolutional block, "3x3" and "2x2" are the kernel size of the convolution/pooling layers. The numbers 64,128 and 256 are the number of filters in the convolutional blocks.

Blocks	Settings
Conv-block1	(3x3@64,BN,Relu)*2
Pooling1	2x2 average pooling
Conv-block2	(3x3@128,BN,Relu)*2
Pooling2	2x2 average pooling
Conv-block3	(3x3@256,BN,Relu)*2
Pooling3	2x2 average pooling
Conv-block4	(3x3@256,BN,Relu)*2
Pooling4	1x1 average pooling
Dense	TimeDistributed
Dense	TimeDistributed
AutoPooling	AutoPool1D

Residual neural networks can significantly improve the performance of deep neural networks and prevent vanishing gradient [53]. Therefore, we introduce a residual block to prevent overfitting for the classes of a small amount of data, as shown in Fig. 2. We simply add the output feature maps of the third convolutional block on the output of the fourth convolutional block. Then the CNN9 based residual architecture is established and denoted as **CNN9-Res**.

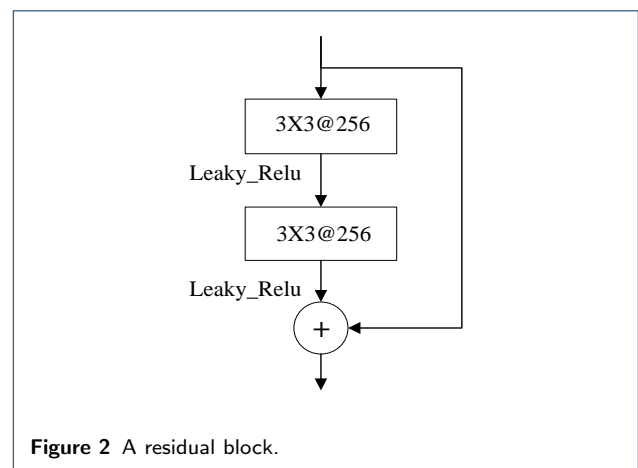

Figure 2 A residual block.

3.3 Spatiotemporal Context

Traditional audio tagging systems only utilize the information of the audio signals. As it is known, the

spatiotemporal context can provide complementary information. The spatial context refers to the location where the sound occurs, including latitude and longitude values. Similarly, temporal context refers to the time when the sound occurs, including the hour, day and week. Therefore, the spatiotemporal context are processed and fed into the models.

The latitude and longitude values are Z-score normalized, and hour, day and week values are transformed to one-hot vector. Both of the spatial and temporal processed values are combined and finally giving a vector of 85 values. Besides the original vector, the spatiotemporal vector is encoded in two other ways, a single fully connected (FC) layer with 32 units or a Long Short-Term Memory (LSTM) layer with 32 units is adopted to encode. After that, the feature maps produced by the last residual or convolutional block are firstly flatten, and concatenated with the spatiotemporal vector on frame-level. Finally, we feed the concatenated feature vector into the classification layers. The diagram of these procedures are shown in Fig. 3.

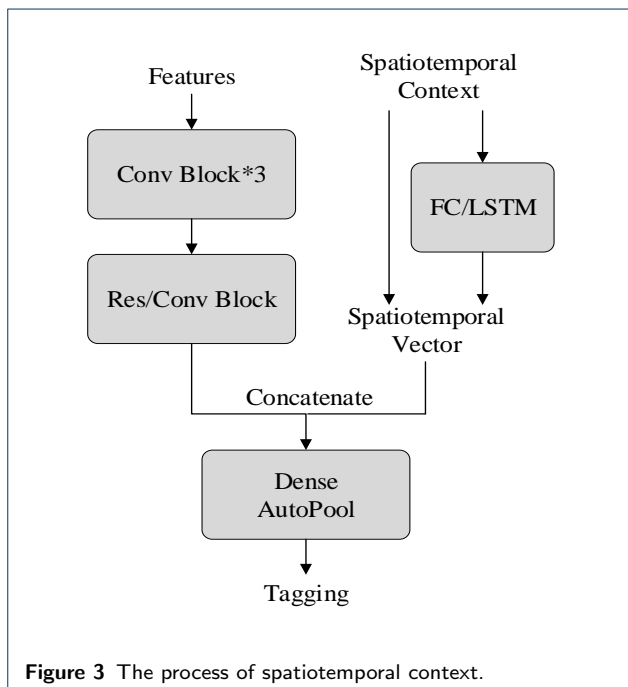

3.4 Data augmentation

Data augmentation is an effective way to improve the generalization ability and prevent overfitting of neural networks. In our system, we employ mixup for data augmentation during training stage [54]. The mixup can be expressed as:

$$\tilde{x} = \lambda x_i + (1 - \lambda)x_j \quad (2)$$

$$\tilde{y} = \lambda y_i + (1 - \lambda)y_j \quad (3)$$

where x_i and x_j are input features, y_i and y_j are the corresponding target labels, $\lambda \in [0, 1]$ is a random number drawn from the $\beta(c, a)$ distribution.

In mixup, new samples are generated by linearly interpolating two real samples within a batch data. Therefore, we can get more training samples without extra computing resource. Note that not only the one-hot labels, but also the spatiotemporal context are mixed during training steps.

3.5 Ensemble Methods

An ensemble of the CNN models can lead to better performance than its components [55]. Therefore, a voting strategy is applied for model fusion, which can be expressed as follows:

$$\mathbf{F}(n, c) = \sum \mathbf{F}_m(n, c) * \mathbf{I}(n, c), \quad (4)$$

where $\mathbf{F}_m(n, c)$ is the prediction matrix of the m^{th} model, $\mathbf{I}(n, c)$ is a matrix in which the j^{th} column is set to 1 if the model achieve the best evaluation score of one coarse class among the models, otherwise it is set to 0, and $*$ represents hadamard product.

4 Experimental settings

4.1 Datasets analysis

We conducted experiments on the development dataset of DCASE2020 task5 [56]. In the dataset, the recordings are acquired using the "Sounds of New York City" (SONYC) acoustic sensor network for urban noise pollution monitoring. It contains almost 18000 recordings with crowd sourced annotations in total. All recordings are grouped into a train set (13538 recordings) and validate set (4308 recordings). The two-level urban sound taxonomy consists of 8 coarse-level and 23 fine-level sound categories, e.g., the coarse alert signal category contains four fine-level categories: reverse beeper, car alarm, car horn, siren. For the sake of expression, the names of coarse classes are replaced by their abbreviations and presented in Table 2. Regarding the complexity of tagging two-level categories, the training and evaluation procedures, and the analysis of results are focused on the coarse-level. In addition, each of the recordings in the SONYC dataset is annotated with from zero to eight categories, thus the UST task is a multi-label classification task.

In order to study the number distribution of coarse-level classes, the presence for each class of all the recordings is calculated in two aspects. The statistics of urban sound recordings are calculated as: only one

Table 2 Coarse-level classes and abbreviations

Coarse classes	Abbreviations
Engine	Engine
Machinery impact	M/C
Non-machinery impact	Non-M/C
Powered saw	Saw
Alert signal	Alert
Music	Music
Human voice	Human
Dog	Dog

class presented or at least one class presented in the recordings. The statistical results are shown in Fig. 4 and 5. It is obvious that the train set is imbalanced among the classes, the number of recordings for music and dog are relative scare comparing with others.

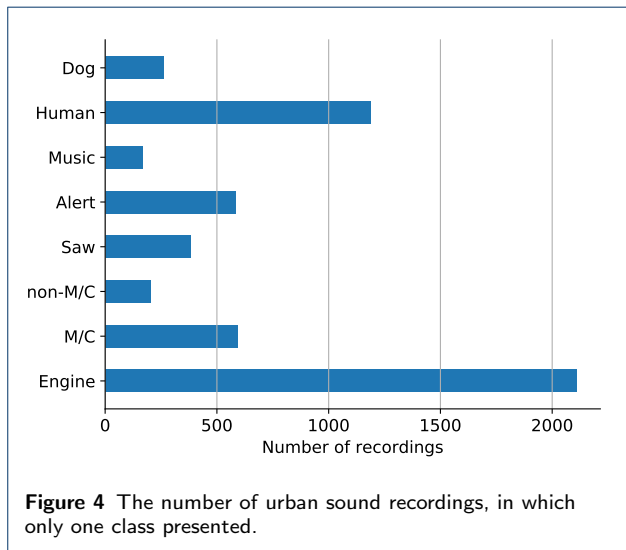
**Figure 4** The number of urban sound recordings, in which only one class presented.

4.2 Data Preparation

All the recordings are resampled to 22050 Hz. And we calculate STFT for each recording with a Hanning window size of 1024 and hop length of 512 samples. Mel filters with bands of 64 are used to transform STFT, harmonic and percussive spectrograms to Mel spectrograms. Meanwhile, linear filters with bands of 64 are applied to generate linear spectrograms, note that frequencies lower than 50 Hz and beyond 10000 Hz are removed. Finally, we transform the obtained spectrograms to decibels and result a 64×431 matrix .

4.3 Evaluation Metrics

The area under the precision-recall curve (AUPRC) is a common evaluation metrics for classification task. In this paper, macro-averaged AUPRC is used to evaluate the performance on the coarse-grained labels, denoted as **macro-auprc**. We vary the threshold τ in macro-auprc between 0 and 1 to compute true positives (TP),

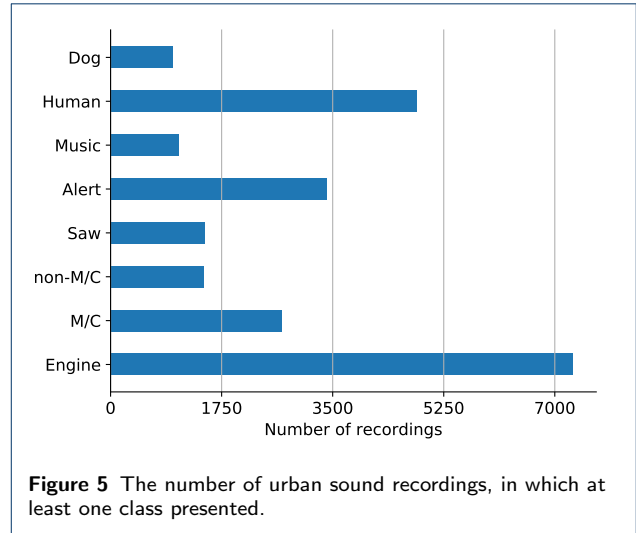
**Figure 5** The number of urban sound recordings, in which at least one class presented.

false positives (FP), and false negatives (FN) for each coarse category as follows,

$$\begin{aligned}
 TP &= (1 - \prod_{k=1}^K (1 - t_k))(1 - \prod_{k=0}^K (1 - y_k)) \\
 FP &= (\prod_{k=1}^K (1 - t_k))(1 - \prod_{k=0}^K (1 - y_k)) \\
 FN &= (1 - \prod_{k=1}^K (1 - t_k))(\prod_{k=0}^K (1 - y_k)),
 \end{aligned} \tag{5}$$

where t_k and y_k respectively represent the presence of fine tag k in the ground truth and prediction. Then we compute micro-averaged precision giving an equal weight to every sample. All values of τ in the interval $[0, 1]$ will be computed to obtain different precision (P) and recall (R). We can compute a set of P and R on every confusion matrix and then we get macro-P and macro-R by averaging them as follows:

$$\begin{aligned}
 \text{macro-P} &= \frac{1}{n} \sum_{i=1}^n P_i \\
 \text{macro-R} &= \frac{1}{n} \sum_{i=1}^n R_i.
 \end{aligned} \tag{6}$$

Finally, we compute the area under the P-R curve to obtain the final macro-auprc.

4.4 Training method

Sigmoid cross entropy is used as loss function. And Adam Optimizer is adopted as optimizer with a learning rate of 0.001. Batch size is set to 64. We take a early stopping strategy if the evaluation metric (i.e.,

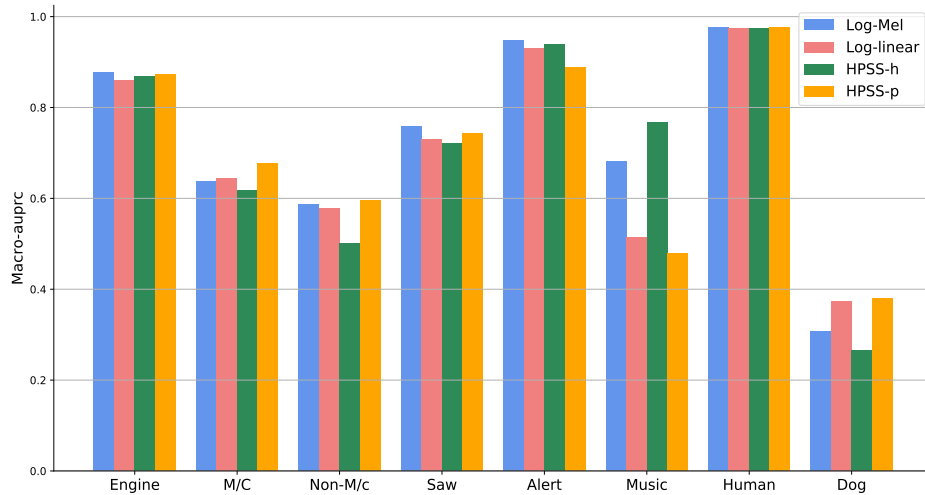

Figure 6 Comparison of CNN9 without mixup for different features

the macro-auprc score over all coarse classes) does not improve in last three steps during training stage. The proposed models are trained and evaluated using Tensorflow on a NVIDIA K80 GPU. The results of models are selected according to the best macro-auprc scores for each coarse class through training epochs.

5 Results and Discussion

5.1 Features

In order to study the ability for detection of different features, we have trained four models based on our primary CNN9 architecture, with log-Mel, log-linear, HPSS-h and HPSS-p respectively. The performances of different features are presented in Fig. 6.

In general, log-Mel shows great capability of detecting all coarse classes and achieves four best scores for engine, saw, alert and human, but it shows a little weakness for dog. Log-linear gets comparable results for most of the coarse classes, especially for dog, but it shows weak capability for finding music. HPSS-h performs the best for music detection, but for non-M/C and dog, it obtains worse scores than other features. Considering M/C, non-M/C and dog, HPSS-p is able to classify these sounds, instead, it does not good at tagging alert and music.

5.2 CNNs with the residual block

The generalization of neural networks can be enhanced through a residual block. Our primary architecture and its modification of adding a residual block are experimented, the performances of CNN9 and CNN9-res with different features are shown in Fig. 7.

In this figure, the impact of the residual block can be studied from four aspects of features, i.e., log-Mel, log-linear, HPSS-h and HPSS-p spectrograms. Log-Mel benefits the most of these features from the residual block. Among the coarse classes, log-Mel achieves relative higher scores for M/C, non-M/C, music and dog, comparing to other classes. However, the macro-auprc scores of log-Mel for saw and alert are worse than the performance without the residual block. As for log-linear, it achieves better performance for engine, M/C and non-M/C, but fails to get better performance in the rest of the classes, especially, even gets much lower score in dog. The similar circumstances are presented in HPSS, both of the HPSS-h and HPSS-p perform even worse for dog. Considering the other classes, HPSS-h only benefits little from the residual block for engine and non-M/C, and HPSS-p benefits not much in non-M/C and music either.

5.3 Spatiotemporal context vector

In order to utilize the spatiotemporal context information, here we introduce three different vectors, i.e., original vector, FC encoded vector and LSTM encoded vector. Table 3 compares nine aspects (macro-auprc scores for each coarse class and averaged macro-auprc score) of these methods. These methods are experimented on the CNN9 without mixup.

Looking at Table 3, in general, performances of each coarse class or the averaged macro-auprc scores of the three methods do not show too many differences. Only,

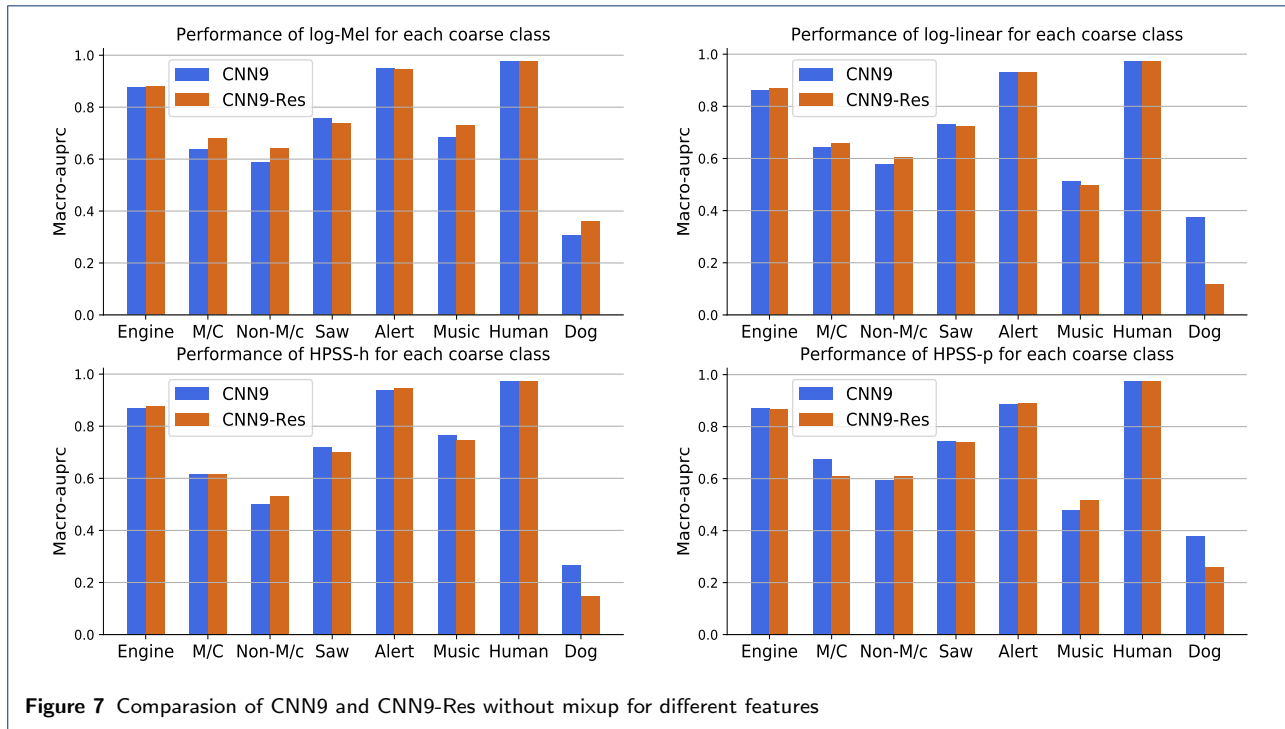

Figure 7 Comparasion of CNN9 and CNN9-Res without mixup for different features

results of LSTM encoded vector for M/C and FC encoded vector for dog improve respectively.

5.4 Mixup

The generalization of models can be improved with little extra computing resource if mixup is applied during the training stage. Therefore, mixup is added in training of CNN9 and CNN9-Res, and the results are shown in Fig. 8 and Fig. 9.

Considering the performances of CNN9 in Fig. 8, all the features can benefit from the data augmentation method for saw. Particularly, log-Mel obtains an impressive improvement for classifying dog, it achieves the best macro-auprc score of 0.511. However, mixup even produces an effect on detecting dog with log-linear, HPSS-h and HPSS-p. Regarding the rest of the results, mixup fails to make significant improvements with different feature on CNN9 as it is supposed.

The bar chart in Fig. 9 shows the macro-auprc scores of mixup used in CNN9-Res. Similar circumstance occurs for saw, all the features obtain improvements by the means of mixup. For HPSS-h, it achieves a higher score for M/C as well, and HPSS-p performs better for

dog. Results presented by the rest of the experiments seems to have little or bad effect on performances.

5.5 Fusion system

The extracted features are fed into CNN9 and CNN9-Res respectively. During training stage, mixup is added and all the results across sixteen models are given in Table 4. Table 4 illustrates that log-Mel based CNN9-Res without mixup achieves the best macro-auprc scores of 0.881, 0.680, 0.641 and 0.977 for engine, M/C, non-M/c and human. Meanwhile, log-Mel based CNN9 with mixup obtains the best scores of 0.956 and 0.511 for alert and dog. HPSS-h based CNN9 without mixup performs the best for detecting music (0.767, the highest macro-auprc score), and HPSS-p based CNN9-Res with mixup obtains the best macro-auprc score of 0.788 for saw. The best performances of models for all coarse classes are detailed in Table 5.

Figure 10 shows the best macro-auprc scores compared with official baseline system provided by the organisers of DCASE2020 task5. The improvement achieved by our approach from the baseline for each coarse class are as follows: 3.65% for engine, 12.96%

Table 3 Experimental results of macro-auprc for each coarse class of encoded vector

Encoded vector	Engine	M/C	Non-M/C	Saw	Alert	Music	Human	Dog	Average
Original	0.877	0.637	0.586	0.758	0.948	0.682	0.976	0.306	0.721
FC	0.875	0.617	0.568	0.743	0.949	0.679	0.977	0.375	0.723
LSTM	0.875	0.664	0.587	0.758	0.948	0.675	0.978	0.348	0.729

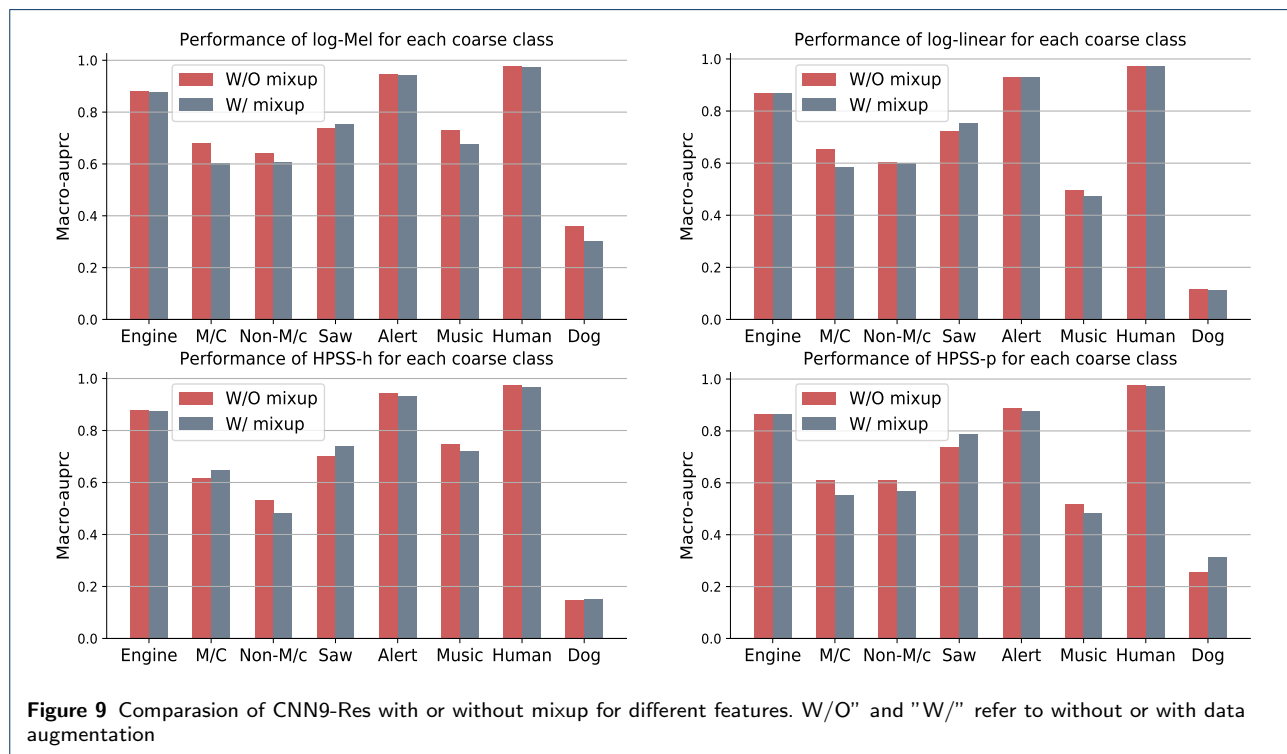
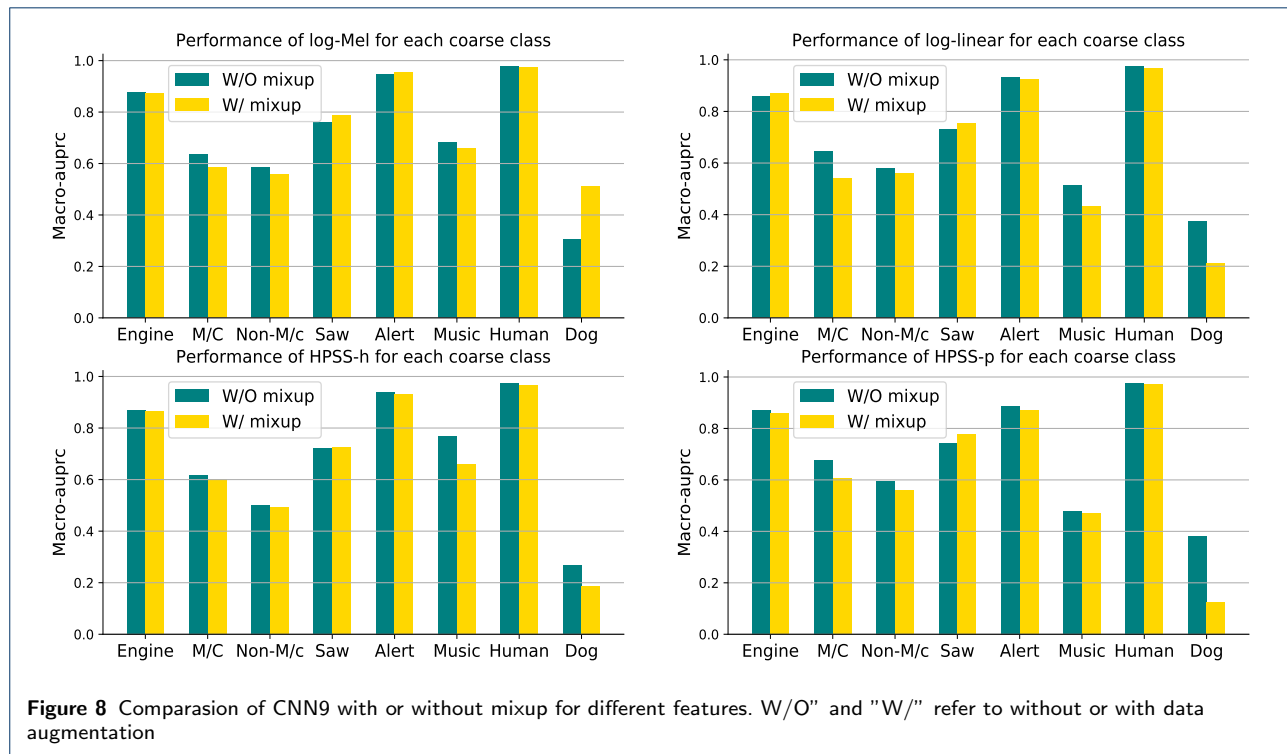

for M/C, 52.98% for non-M/C, 9.44% for saw, 12.21% for alert, 24.72% for music, 1.88% for human and 1010.87% for dog. Depending on Table 5, an ensemble method is implemented to get the fused output.

Finally, we achieve a macro-auprc score of 0.775 averaged on the coarse-level classes and a 22.63% improvement compared with baseline.

Table 4 Experimental results of models for coarse classes. "W/O" and "W/" refer to without or with data augmentation. Best scores of each coarse class are denoted in bold.

Architecture	Augmentation	Feature	Engine	M/C	Non-M/C	Saw	Alert	Music	Human	Dog
CNN9	W/O mixup	Log-Mel	0.877	0.637	0.586	0.758	0.948	0.682	0.976	0.306
		Log-linear	0.860	0.644	0.578	0.730	0.930	0.513	0.973	0.374
		HPSS-h	0.869	0.618	0.501	0.720	0.939	0.767	0.974	0.266
		HPSS-p	0.872	0.677	0.595	0.743	0.888	0.478	0.976	0.380
	W/ mixup	Log-Mel	0.874	0.586	0.557	0.787	0.956	0.658	0.972	0.511
		Log-linear	0.868	0.541	0.560	0.754	0.923	0.433	0.967	0.211
		HPSS-h	0.865	0.601	0.491	0.725	0.930	0.658	0.966	0.188
		HPSS-p	0.858	0.605	0.558	0.779	0.870	0.471	0.973	0.125
CNN9-Res	W/O mixup	Log-Mel	0.881	0.680	0.641	0.738	0.945	0.729	0.977	0.361
		Log-linear	0.870	0.656	0.603	0.723	0.929	0.495	0.972	0.116
		HPSS-h	0.879	0.616	0.531	0.702	0.946	0.748	0.974	0.149
		HPSS-p	0.867	0.609	0.609	0.739	0.889	0.519	0.976	0.258
	W/ mixup	Log-Mel	0.876	0.602	0.607	0.755	0.943	0.678	0.972	0.304
		Log-linear	0.869	0.585	0.601	0.754	0.931	0.475	0.971	0.114
		HPSS-h	0.873	0.649	0.481	0.742	0.931	0.722	0.968	0.150
		HPSS-p	0.866	0.552	0.567	0.788	0.875	0.483	0.972	0.312

Table 5 The best performances of approaches.

Coarse classes	Macro-auprc	Architecture	Augmentation	Feature
Engine	0.881	CNN9-Res	-	Log-Mel
M/C	0.680	CNN9-Res	-	Log-Mel
Non-M/C	0.641	CNN9-Res	-	Log-Mel
Saw	0.788	CNN9-Res	Mixup	HPSS-p
Alert	0.956	CNN9	Mixup	Log-Mel
Music	0.767	CNN9	-	HPSS-h
Human	0.977	CNN9-Res	-	Log-Mel
Dog	0.511	CNN9	Mixup	Log-Mel

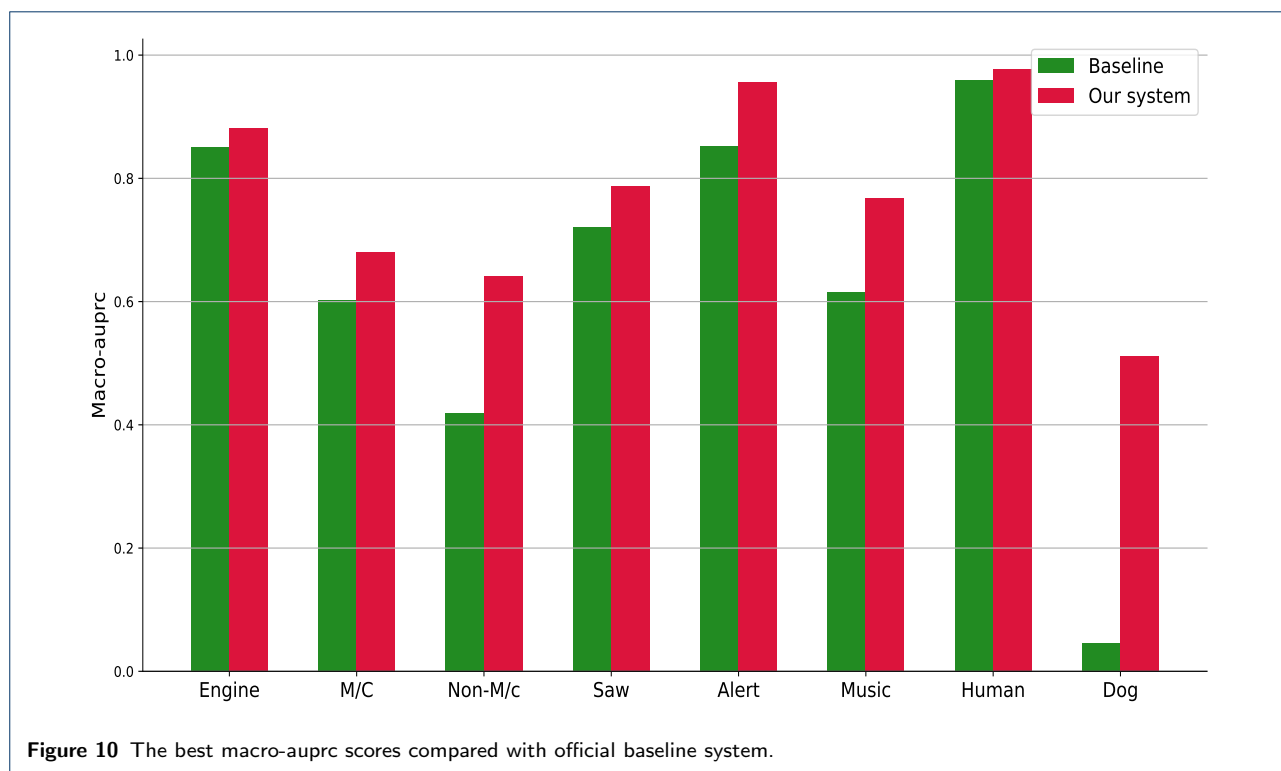

Figure 10 The best macro-auprc scores compared with official baseline system.

Table 6 Distractor analysis 1.

Single label		Distractor		
Classes	Number	Classes	Number	Ratio
Engine	73	Human	2	2/73
M/C	11	Engine	3	3/11
Non-M/C	5	-	-	-
Saw	10	Engine	1	1/10
Alert	37	Engine	1	1/37
		Engine	2	2/9
		Non-M/C	1	1/9
Music	9	Saw	1	1/9
		Alert	1	1/9
		Human	1	1/9
Human	104	Engine	1	1/104
		Saw	1	1/104
Dog	2	Human	1	1/2

5.6 Distractor analysis

Regarding the label of each recording in validation dataset, it can be a single label or a multi-label. Investigating the confusion between classes can help us analyze the characteristics of the coarse classes and further improve the performance for tagging urban sound. Although confusion matrix is an effective evaluation measurement and usually used in classification tasks, for a multi-label task, it is too complicated to draw all the confusion matrices.

Therefore, we introduce a primary method to analyze the distractors for each class. For a recording, the true label of it can be expressed as $T = \{t_1, t_2, \dots, t_n\}, n = 8$, and the prediction of this recording can be expressed as $P = \{p_1, p_2, \dots, p_n\}, n = 8$. This method can be described in two aspects and both of them are based on the recordings with single label in validate set. On the one hand, for a true tag T and a prediction P of a recording, if $t_n = 1$ and $t_m = 0 (\forall m \neq n)$ and $p_n = 0$ and $p_m = 1 (\exists m \neq n)$, the distracted class n will be recorded. For example, if the true label of a recording is only labeled as engine, and the prediction of it is labeled as human or human and saw, the distracted number of human or human and saw is added. The distractors are detailed in Table 6.

On the other hand, for a true tag T and a prediction P of a recording, if $t_n = 1$ and $t_m = 0 (\forall m \neq n)$ and $p_n = 1$ and $p_m = 1 (\exists m \neq n)$, similarly, the distracted class n will be recorded as well. The distractors in this situation are shown in Table 7.

5.7 Discussion

Comparing the performances of features, we underline that log-Mel spectrogram outperforms log-linear and HPSS spectrograms in general and achieves the best performances for engine, M/C, non-M/C, alert, human and dog. The coarse-level classes in urban environment have various characteristics in low frequencies,

Table 7 Distractor analysis 2.

Single label		Distractor		
Classes	Number	Classes	Number	Ratio
Engine	73	Human	2	2/73
		Saw	2	2/73
		Alert	1	1/73
M/C	11	Saw	3	3/11
		Human	1	1/11
Non-M/C	5	Engine	1	1/5
Saw	10	Engine	1	1/10
Alert	37	Engine	9	9/37
		Human	5	5/37
Music	9	Human	5	5/9
		Engine	1	1/9
		Engine	10	10/104
Human	104	Alert	7	7/104
		Music	2	2/104
		Dog	2	2/104
Dog	2	-	-	-

and most of them can be tagged by log-Mel spectrogram because of its high resolution in low frequencies. Even there are some good empirical results, but still no top performance for log-linear spectrogram, the help of high resolution in high frequencies for UST seems limited. However, HPSS-h spectrogram shows great ability to correctly classify music, this prove that the harmonic components in music is more differentiable than the others. In addition, HPSS-p achieves good results for M/C and dog, and gets the best performance of saw, this may partly due to the distinguishable percussive components in saw. Some examples of spectrogram which achieves the best result for each coarse class are presented in Fig. 11.

Based on the different features, CNN9-Res achieves better performances than CNN9, in principle. It is proved that residual block can effectively improve the performance of tagging diverse urban sound. To solve the problem of imbalance classes, we apply a data augmentation in our UST system. By using mixup, we achieve excellent results for saw and alert, especially for dog, almost 67% improvement from the log-Mel spectrogram based CNN9 model. Although the macro-auprc scores for some classes degrade, the performances for the classes of less data has a great improvement.

To handle the spatiotemporal context, three methods are applied, and two of them encode the spatiotemporal information into a encoded vector by neural networks. However, FC and LSTM methods perform a bit better for some coarse classes, the averaged macro-auprc scores do not improve much and these methods introduce more system complexities. Therefore, we mainly use the original method to deal with the spatiotemporal context and feed it into the UST system.

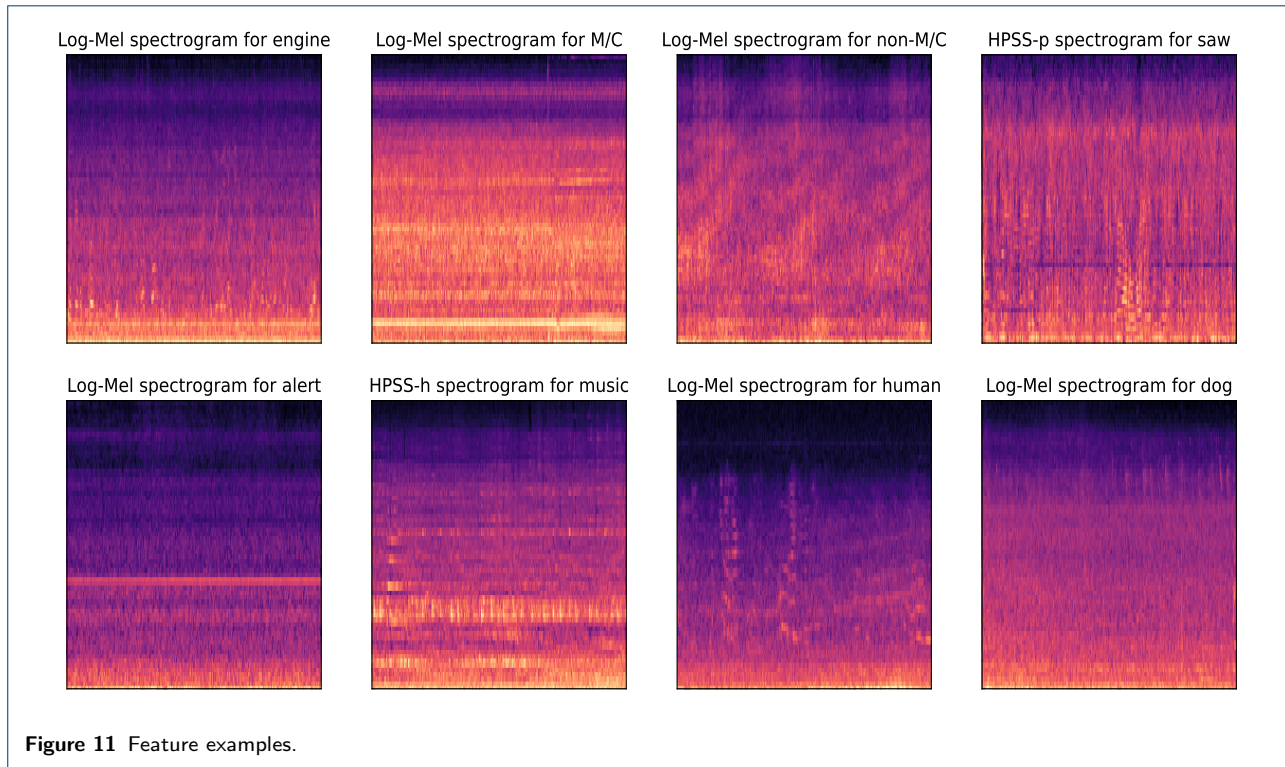

As for the fusion system, we ensemble the models according to the best performance of each coarse class. By fusing the prediction results for each class, we get the final scores on evaluation metrics. We compare the fused system with the official system provided by DCASE2020 task5, in which the spatiotemporal context is encoded to help classify urban sound as well, and we denote it as **Baseline-2020**. Finally, our system obtain a 18.7% improvement on averaged macro-auprc compared to the DCASE2020 task5 baseline system. In addition, the results of other competitors are given in Table 8.

Table 8 Final scores on evaluation metrics for UST systems of competitors

Competitors	Macro-auprc
Arnault, A. et al. [57]	0.811
Our system	0.775
Iqbal, T. et al.[58]	0.767
Baseline-2020	0.632
Diez, I. et al. [59]	0.591

The most distracted class among the classes in Table 6, is engine, and it cause a major negative confusion for M/C and music. Human disturbs recognising for engine, music and especially dog. But in general, the number of distractors are not enough to show more information. Another aspect of distractor analysis is presented in Table 7. Engine distracts detecting most

of the classes, and it is the major distractor for alert and human. An interesting relationship between human and music can be revealed from the distractors for these two classes: music contains not only sounds of instruments but also lots of vocals, this leads to the confusion when tagging music or human. As for alert and human, in some emergency cases, there could be alert sounds accompanied with human voices, e.g., shout or scream, this may cause the distraction between these classes.

Considering the major distractors in Table 6 and 7, the reason why engine is usually incorrectly classified may be the indistinct definition of engine, M/C, saw and other sounds of machines. Meanwhile, the production of urban sound are predominantly related to human activities, and sometimes this makes sense of the confusions between human and other classes.

6 Conclusions

In this paper, we have proposed a CNN based system for UST with spatiotemporal context. In our approach, four different features are extracted as inputs of the networks. To eliminate the imbalance problem of the dataset, a data augmentation strategy, i.e. mixup, is applied during the training. Finally, we fuse different features and data augmentation based models to form our final UST system.

Regarding the features, the diversity of urban sounds can be detected by utilizing different kinds of time-

frequency representations. Log-Mel spectrogram outperforms other features for detecting most of the coarse-level urban sounds, and this may be due to its high resolution in relative low frequencies. The experimental results of HPSS-h spectrogram demonstrate that the harmonic component separated from music is effective for classification. As for the percussive component of a signal, it can improve the performance of tagging saw. These empirical facts inspire us to take advantages of characteristic features for UST or ESR tasks.

In addition, results on evaluation metrics indicate that, the residual block and mixup method can significantly improve the performance for tagging various urban sounds. The ensemble method adopted in our approach outperforms a single model and achieves a leading performance for UST.

Distractor analysis provides another aspect of UST, it is worth exploring the relationship among urban sounds. For example, the confusion between human and music or alert implies the overlap or common internal connection.

In the future, taking advantages of high resolution in high frequencies of log-linear needs to be studied. Performances of the implementations of spatiotemporal context motivate us to find available means of extracting context-based information. Moreover, we will further explore whether the major distractor, i.e. engine, is caused by the imbalance of dataset.

References

- Ghosh, A., Kumari, K., Kumar, S., Saha, M., Nandi, S., Saha, S.: Noiseprobe: Assessing the dynamics of urban noise pollution through participatory sensing. In: 2019 11th International Conference on Communication Systems Networks (COMSNETS), pp. 451–453 (2019)
- Bello, J.P., Silva, C., Nov, O., Dubois, R.L., Arora, A., Salamon, J., Mydlarz, C., Doraiswamy, H.: Sonyc: A system for monitoring, analyzing, and mitigating urban noise pollution. *Communications of the ACM* **62**(2), 68–77 (2019). doi:10.1145/3224204
- Stansfeld, S.A., Matheson, M.P.: Noise pollution: non-auditory effects on health. *British medical bulletin* **68**(1), 243–257 (2003)
- Cartwright, M., Mendez, A.E.M., Cramer, J., Lostonlen, V., Dove, G., Wu, H.-H., Salamon, J., Nov, O., Bello, J.: SONYC urban sound tagging (SONYC-UST): A multilabel dataset from an urban acoustic sensor network. In: Proceedings of the Workshop on Detection and Classification of Acoustic Scenes and Events (DCASE), pp. 35–39 (2019)
- Becker, M., Caminiti, S., Fiorella, D., Francis, L., Gravino, P., Haklay, M., Hotho, A., Loreto, V., Mueller, J., Ricchiuti, F.: Awareness and learning in participatory noise sensing. *Plos One* (2013)
- Bell, M.C., Galatioto, F.: Novel wireless pervasive sensor network to improve the understanding of noise in street canyons. *Applied acoustics* (2013)
- Wold, E., Blum, T., Keislar, D., Wheaton, J.: Content-based classification, search, and retrieval of audio. *IEEE multimedia* **3**(3), 27–36 (1996)
- Tzanetakis, G., Cook, P.: Musical genre classification of audio signals. *IEEE Transactions on speech and audio processing* **10**(5), 293–302 (2002)
- Wieczorkowska, A.A., Ras, Z.W., Zhang, X., Lewis, R.: Multi-way hierarchic classification of musical instrument sounds. In: 2007 International Conference on Multimedia and Ubiquitous Engineering (MUE'07), pp. 897–902 (2007). IEEE
- Xu, Y., Li, W.J., Lee, K.K.C.: *Intelligent Wearable Interfaces*. Wiley Online Library
- Valenzise, G., Gerosa, L., Tagliasacchi, M., Antonacci, F., Sarti, A.: Scream and gunshot detection and localization for audio-surveillance systems. In: 2007 IEEE Conference on Advanced Video and Signal Based Surveillance, pp. 21–26 (2007). IEEE
- <https://www.imageclef.org/BirdCLEF2020>
- Salamon, J., Bello, J.P.: Unsupervised feature learning for urban sound classification. In: 2015 IEEE International Conference on Acoustics, Speech and Signal Processing (ICASSP), pp. 171–175 (2015)
- Zhang, Z., Xu, S., Zhang, S., Qiao, T., Cao, S.: Learning frame level attention for environmental sound classification. *arXiv preprint arXiv:2007.07241* (2020)
- <http://dcase.community/challenge2020/>
- Mesaros, A., Heittola, T., Virtanen, T.: Tut database for acoustic scene classification and sound event detection. In: 2016 24th European Signal Processing Conference (EUSIPCO), pp. 1128–1132 (2016). IEEE
- Dufaux, A., Besacier, L., Ansong, M., Pellandini, F.: Automatic sound detection and recognition for noisy environment. In: 2000 10th European Signal Processing Conference, pp. 1–4 (2000)
- Chu, S., Narayanan, S., Kuo, C.-C.J.: Environmental sound recognition with time–frequency audio features. *IEEE Transactions on Audio, Speech, and Language Processing* **17**(6), 1142–1158 (2009)
- Salamon, J., Bello, J.P.: Deep convolutional neural networks and data augmentation for environmental sound classification. *IEEE Signal Processing Letters* **24**(3), 279–283 (2017)
- Xu, Y., Kong, Q., Wang, W., Plumbley, M.D.: Surrey-CVSSP system for DCASE2017 challenge task4. Technical report, DCASE2017 Challenge (September 2017)
- Vuegen, L., Karsmakers, P., Vanrumste, B., et al.: Weakly-supervised classification of domestic acoustic events for indoor monitoring applications. In: In Proceedings of IEEE Conference on Biomedical and Health Informatics 2018 (2018). IEEE
- Adapa, S.: Urban sound tagging using convolutional neural networks. *arXiv preprint arXiv:1909.12699* (2019)
- Cramer, J., Wu, H.-H., Salamon, J., Bello, J.P.: Look, listen, and learn more: Design choices for deep audio embeddings. In: ICASSP 2019-2019 IEEE International Conference on Acoustics, Speech and Signal Processing (ICASSP), pp. 3852–3856 (2019). IEEE
- Gemmeke, J.F., Ellis, D.P., Freedman, D., Jansen, A., Lawrence, W., Moore, R.C., Plakal, M., Ritter, M.: Audio set: An ontology and human-labeled dataset for audio events. In: 2017 IEEE International Conference on Acoustics, Speech and Signal Processing (ICASSP), pp. 776–780 (2017). IEEE
- Hershey, S., Chaudhuri, S., Ellis, D.P., Gemmeke, J.F., Jansen, A., Moore, R.C., Plakal, M., Platt, D., Saurous, R.A., Seybold, B., et al.: Cnn architectures for large-scale audio classification. In: 2017 IEEE International Conference on Acoustics, Speech and Signal Processing (icassp), pp. 131–135 (2017). IEEE
- Ng, L., Ooi, K.: Urban sound tagging DCASE 2019 challenge task 5. Technical report, DCASE2019 Challenge (September 2019)
- Serizel, R., Turpault, N., Eghbal-Zadeh, H., Shah, A.P.: Large-scale weakly labeled semi-supervised sound event detection in domestic environments. *arXiv preprint arXiv:1807.10501* (2018)
- Kong, Q., Cao, Y., Iqbal, T., Xu, Y., Wang, W., Plumbley, M.D.: Cross-task learning for audio tagging, sound event detection and spatial localization: Dcase 2019 baseline systems. *arXiv preprint arXiv:1904.03476* (2019)
- Chachada, S., Kuo, C.-C.J.: Environmental sound recognition: A survey. *APSIPA Transactions on Signal and Information Processing* **3** (2014)
- Chen, J., Kam, A.H., Zhang, J., Liu, N., Shue, L.: Bathroom activity monitoring based on sound. In: International Conference on Pervasive Computing, pp. 47–61 (2005). Springer
- Bardeli, R., Wolff, D., Kurth, F., Koch, M., Tauchert, K.-H., Frommolt, K.-H.: Detecting bird sounds in a complex acoustic environment and application to bioacoustic monitoring. *Pattern Recognition Letters* **31**(12), 1524–1534 (2010)
- Duan, S., Zhang, J., Roe, P., Towsey, M.: A survey of tagging techniques for music, speech and environmental sound. *Artificial*

- Intelligence Review 42(4), 637–661 (2014)
33. Cowling, M., Sitte, R.: Comparison of techniques for environmental sound recognition. *Pattern recognition letters* 24(15), 2895–2907 (2003)
 34. Chandrakala, S., Jayalakshmi, S.: Environmental audio scene and sound event recognition for autonomous surveillance: A survey and comparative studies. *ACM Computing Surveys (CSUR)* 52(3), 1–34 (2019)
 35. Heittola, T., Mesaros, A., Eronen, A., Virtanen, T.: Context-dependent sound event detection. *EURASIP Journal on Audio, Speech, and Music Processing* 2013(1), 1 (2013)
 36. Salamon, J., Jacoby, C., Bello, J.P.: A dataset and taxonomy for urban sound research. In: *Proceedings of the 22nd ACM International Conference on Multimedia*, pp. 1041–1044 (2014)
 37. Cotton, C.V., Ellis, D.P.: Spectral vs. spectro-temporal features for acoustic event detection. In: *2011 IEEE Workshop on Applications of Signal Processing to Audio and Acoustics (WASPAA)*, pp. 69–72 (2011). IEEE
 38. Schröder, J., Moritz, N., Schädler, M.R., Cauchi, B., Adiloglu, K., Anemüller, J., Doclo, S., Kollmeier, B., Goetze, S.: On the use of spectro-temporal features for the ieee aasp challenge 'detection and classification of acoustic scenes and events'. In: *2013 IEEE Workshop on Applications of Signal Processing to Audio and Acoustics*, pp. 1–4 (2013). IEEE
 39. McLoughlin, I., Zhang, H., Xie, Z., Song, Y., Xiao, W.: Robust sound event classification using deep neural networks. *IEEE/ACM Transactions on Audio, Speech, and Language Processing* 23(3), 540–552 (2015)
 40. Cakir, E., Parascandolo, G., Heittola, T., Huttunen, H., Virtanen, T.: Convolutional recurrent neural networks for polyphonic sound event detection. *IEEE/ACM Transactions on Audio, Speech, and Language Processing* 25(6), 1291–1303 (2017)
 41. Akiyama, O., Sato, J.: Multitask learning and semisupervised learning with noisy data for audio tagging. *DCASE2019 Challenge* (2019)
 42. Xing, Z.: Modeling of the latent embedding of music using deep neural network. *Google Patents*. US Patent App. 15/466,533 (2018)
 43. Zhang, Z., Xu, S., Cao, S., Zhang, S.: Deep convolutional neural network with mixup for environmental sound classification. In: *Chinese Conference on Pattern Recognition and Computer Vision (PRCV)*, pp. 356–367 (2018). Springer
 44. Loris, N., Aguiar, R.L., Mangolin, R.B., Sheryl, B., N Jr, S.C., et al.: Ensemble of convolutional neural networks to improve animal audio classification. *EURASIP Journal on Audio, Speech, and Music Processing* 2020(1) (2020)
 45. Bai, J., Chen, C., Chen, J.: A multi-feature fusion based method for urban sound tagging. In: *2019 Asia-Pacific Signal and Information Processing Association Annual Summit and Conference (APSIPA ASC)*, pp. 1313–1317 (2019)
 46. Jeong, I.-Y., Lee, S., Han, Y., Lee, K.: Audio event detection using multiple-input convolutional neural network. *Detection and Classification of Acoustic Scenes and Events (DCASE)* (2017)
 47. Kiyokawa, Y., Mishima, S., Toizumi, T., Sagi, K., Kondo, R., Nomura, T.: Sound event detection with resnet and self-mask module for dcase 2019 task 4. *Tech. Rep.* (2019)
 48. Huzaifah, M.: Comparison of time-frequency representations for environmental sound classification using convolutional neural networks. *arXiv preprint arXiv:1706.07156* (2017)
 49. Kathania, H.K., Shahnawazuddin, S., Ahmad, W., Adiga, N.: Role of linear, mel and inverse-mel filterbanks in automatic recognition of speech from high-pitched speakers. *Circuits, Systems, and Signal Processing* 38(10), 4667–4682 (2019)
 50. Fitzgerald, D.: Harmonic/percussive separation using median filtering. *13th International Conference on Digital Audio Effects (DAFx-10)* (2010)
 51. Tachibana, H., Ono, N., Sagayama, S.: Singing voice enhancement in monaural music signals based on two-stage harmonic/percussive sound separation on multiple resolution spectrograms. *IEEE/ACM Transactions on Audio, Speech, and Language Processing* 22(1), 228–237 (2013)
 52. Ioffe, S., Szegedy, C.: Batch normalization: Accelerating deep network training by reducing internal covariate shift. *arXiv preprint arXiv:1502.03167* (2015)
 53. He, K., Zhang, X., Ren, S., Sun, J.: Deep residual learning for image recognition. In: *Proceedings of the IEEE Conference on Computer Vision and Pattern Recognition (CVPR)* (2016)
 54. Zhang, H., Cisse, M., Dauphin, Y.N., Lopez-Paz, D.: mixup: Beyond empirical risk minimization. *arXiv preprint arXiv:1710.09412* (2017)
 55. Wang, M., Wang, R., Zhang, X., Rahardja, S.: Hybrid constant-q transform based cnn ensemble for acoustic scene classification. In: *2019 Asia-Pacific Signal and Information Processing Association Annual Summit and Conference (APSIPA ASC)*, pp. 1511–1516 (2019)
 56. Cartwright, M., Cramer, J., Mendez, A.E.M., Wang, Y., Wu, H.-H., Lostanlen, V., Fuentes, M., Dove, G., Mydlarz, C., Salamon, J., et al.: Sonyc-ust-v2: An urban sound tagging dataset with spatiotemporal context. *arXiv preprint arXiv:2009.05188* (2020)
 57. Arnault, A., Riche, N.: CRNNs for urban sound tagging with spatiotemporal context. *Technical report, DCASE2020 Challenge* (October 2020)
 58. Iqbal, T., Cao, Y., Plumbley, M.D., Wang, W.: Incorporating auxiliary data for urban sound tagging. *Technical report, DCASE2020 Challenge* (October 2020)
 59. Diez, I., Gonzalez, P., Gonzalez, I.: Urban sound classification using convolutional neural networks for DCASE 2020 challenge. *Technical report, DCASE2020 Challenge* (October 2020)