

Nonlinear Attitude Filter on SO(3): Fast Adaptation and Robustness

Ajay Singh, Trenton S. Sieb, James H. Howe, and Hashim A. Hashim
Software Engineering

Department of Engineering and Applied Science

Thompson Rivers University, Kamloops, British Columbia, Canada, V2C-0C8
ludhera17@mytru.ca, siebt19@mytru.ca, howej15@mytru.ca, and hhashim@tru.ca

Abstract—Nonlinear attitude filters have been recognized to have simpler structure and better tracking performance when compared with Gaussian attitude filters and other methods of attitude determination. A key element of nonlinear attitude filter design is the selection of error criteria. The conventional design of nonlinear attitude filters has a trade-off between fast adaptation and robustness. In this work, a new functional approach based on fuzzy rules for on-line continuous tuning of the nonlinear attitude filter adaptation gain is proposed. The input and output membership functions are optimally tuned using artificial bee colony optimization algorithm taking into account both attitude error and rate of change of attitude error. The proposed approach results of high adaptation gain at large error and small adaptation gain at small error. Thereby, the proposed approach allows fast convergence properties with high measures of robustness. The simulation results demonstrate that the proposed approach offers robust and high convergence capabilities against large error in initialization and uncertain measurements.

I. INTRODUCTION

ESTIMATION of rigid-body orientation in the 3D space is an indispensable process in robotics and engineering applications such as unmanned aerial vehicles, mobile robots, underwater vehicles, radar, or satellites [1–8]. The orientation of the rigid-body can be reconstructed mathematically given at least two inertial observations and their body-frame measurements, for instance, utilizing QUEST computations and singular value decomposition (SVD) [9,10]. In any case, body-frame estimations are contaminated with unknown constant bias and random noise elements and the static solutions in [9,10] give unreasonable outcomes, particularly if the moving body is equipped with cheap measurement units, such as inertial measurements units (IMUs) [1,3,4,6].

Over the last two decades, a surprising effort has been done to accomplish higher estimation capabilities through Gaussian filters. Gaussian attitude filters includes the Extended Kalman Filter (EKF) in [11], novel Kalman filter in [12], Multiplicative extended Kalman filter [6], and others. A more recent survey of Gaussian attitude filters are described in [1]. Nonlinear deterministic attitude filters have better performance, and demand less computational energy when contrasted with Gaussian filters [1,4]. In addition, they are simpler in derivation.

Therefore, nonlinear attitude filters got considerable attention [1,4,13].

The need for attitude filters that are robust against ambiguity in estimation sensors, particularly with the advancement in low cost IMUs, contributed to the improvement of nonlinear attitude filters. These filters can be effectively fitted knowing a rate gyroscope measurement and at least two vectorial estimations taken, for example, by IMUs. The nonlinear attitude filter is accomplished by means of careful selection of the attitude error function. While the chosen error function in [4] experienced slight alterations in other works, overall functioning was essentially unchanged. The main issue of the error function in [4] is the slow convergence, particularly with large initial attitude error. Other attitude error functions were proposed to improve the transient performance as well as the robustness factor, for instance [3,13].

Fuzzy logic controller (FLC) is classified as an intelligent approach which showed significant solutions in a wide range of control applications, for instance, adaptively tuned filter of an \mathcal{L}_1 adaptive controller [14] and adaptive fuzzy controller for mobile robots [15]. Evolutionary techniques witnessed rapid developments over the last few decades and they have the potential to be an optimal fit for various control applications such as artificial bee colony (ABC) which was proposed as a global search technique in [16]. Also, they have essential role in data mining [17–19]. The necessity to tune originally fixed coefficients of controllers and filters has been widely used in various applications, such as [14,20].

To this end, this study proposes fuzzy tuning the gain of the nonlinear attitude filter, where the fuzzy input and output membership functions are optimized by ABC taking into account the attitude error and its rate of change. The FLC-based tuning, is on-line and carried out during operation. ABC identifies the optimal values of input and output membership functions through off-line tuning. FLC is introduced to improve the trade-off between robustness and fast convergence. The gain of the nonlinear attitude filter is dynamically tuned, allowing for better performance. In fact, the proposed approach allows the dilemma of fast adaptation and convergence response to be solved. The method is simpler and can be easily implemented in comparison with the literature.

The rest of the paper is composed as follows: Section II gives a short overview of the numerical and mathematical representation, $SO(3)$ parameterization, articulates the attitude

problem, demonstrates the estimator structure and error criteria, and presents the nonlinear structure of the attitude filter. Section III presents the proposed filter strategy which includes a brief introduction of the artificial bee colony algorithm, fuzzy logic controller, and diagram of the implementation process. Section IV presents the obtained results and validates the robustness of the proposed filters. At long last, Section V summarizes the work with finished up comments.

II. PRELIMINARIES & PROBLEM FORMULATION

The objective of this section is to introduce 1) attitude preliminaries, 2) the attitude estimation problem, 3) the available body-frame measurements, 4) error criteria, and 5) nonlinear filter design.

A. Preliminaries

In this paper $\{\mathcal{B}\}$ denotes body-frame of a reference and $\{\mathcal{I}\}$ denotes inertial-frame of a reference. \mathbb{R}_+ is the set of non-negative real numbers, $\mathbb{R}^{p \times q}$ is real $p \times q$ dimensional space. $\|x\| = \sqrt{x^\top x}$ refers to the Euclidean norm of $x \in \mathbb{R}^p$. \mathbf{I}_p refers to a p -by- p identity matrix. $R \in \{\mathcal{B}\}$ denotes an orientation of a rigid-body in the space which is commonly known as attitude. Define $SO(3)$ as the Special Orthogonal Group. The orientation of a rigid-body in space is defined by

$$SO(3) = \{R \in \mathbb{R}^{3 \times 3} \mid RR^\top = R^\top R = \mathbf{I}_3, \det(R) = +1\}$$

such that \mathbf{I}_3 is an identity matrix of dimension 3 and $\det(\cdot)$ is a determinant. The Lie-algebra associated with $SO(3)$ is known by $\mathfrak{so}(3)$ and is represented by

$$\mathfrak{so}(3) = \{X \in \mathbb{R}^{3 \times 3} \mid X^\top = -X\}$$

where X is a skew symmetric matrix. Consider the map $[\cdot]_\times : \mathbb{R}^3 \rightarrow \mathfrak{so}(3)$ to be

$$[x]_\times = \begin{bmatrix} 0 & -x_3 & x_2 \\ x_3 & 0 & -x_1 \\ -x_2 & x_1 & 0 \end{bmatrix} \in \mathfrak{so}(3), \quad x = \begin{bmatrix} x_1 \\ x_2 \\ x_3 \end{bmatrix}$$

Define $[x]_\times y = x \times y$ where \times is the cross product $\forall x, y \in \mathbb{R}^3$. Let the inverse map of $[\cdot]_\times$ be defined by $\text{vex} : \mathfrak{so}(3) \rightarrow \mathbb{R}^3$

$$\text{vex}([x]_\times) = x \in \mathbb{R}^3 \quad (1)$$

The anti-symmetric projection operator on the Lie-algebra $\mathfrak{so}(3)$ is given by \mathcal{P}_a with $\mathcal{P}_a : \mathbb{R}^{3 \times 3} \rightarrow \mathfrak{so}(3)$ such that

$$\mathcal{P}_a(K) = \frac{1}{2}(K - K^\top) \in \mathfrak{so}(3), \quad K \in \mathbb{R}^{3 \times 3} \quad (2)$$

Additionally, the identity below will be used throughout the paper

$$\text{Tr}\{K[x]_\times\} = \text{Tr}\{\mathcal{P}_a(K)[x]_\times\} = -2\text{vex}(\mathcal{P}_a(K))^\top x \quad (3)$$

where $\text{Tr}\{\cdot\}$ denotes trace. For more details, visit [1,13].

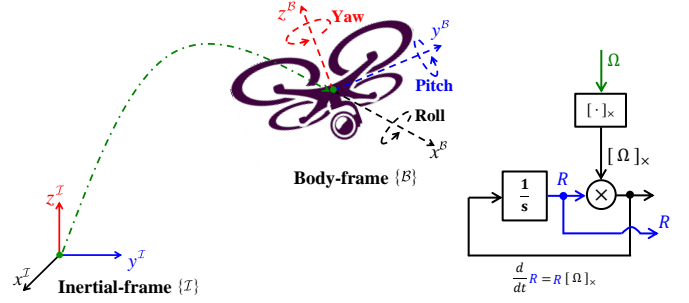

Fig. 1. Attitude estimation problem [1].

B. Attitude Dynamics and Measurements

The attitude of a rigid-body is described by $R \in SO(3)$. Note that $R \in \{\mathcal{B}\}$. The attitude estimation problem of a rigid-body is depicted in Fig. 1.

Consider the superscripts \mathcal{B} and \mathcal{I} to be the components associated with $\{\mathcal{B}\}$ and $\{\mathcal{I}\}$, respectively. The orientation can be represented by n known observations in $\{\mathcal{I}\}$ and their measurements in $\{\mathcal{B}\}$. The i th vector measurement is

$$v_i^{\mathcal{B}} = R^\top v_i^{\mathcal{I}} + b_i^{\mathcal{B}} + n_i^{\mathcal{B}} \in \mathbb{R}^3 \quad (4)$$

where $v_i^{\mathcal{I}}$ is the known i th observation, $b_i^{\mathcal{B}}$ is unknown bias, and $n_i^{\mathcal{B}}$ is unknown random noise for all $i = 1, 2, \dots, n$. The vectors $v_i^{\mathcal{I}}$ and $v_i^{\mathcal{B}}$ in Eq. (4) can be normalized as below:

$$v_i^{\mathcal{I}} = \frac{v_i^{\mathcal{I}}}{\|v_i^{\mathcal{I}}\|} \in \{\mathcal{I}\}, \quad v_i^{\mathcal{B}} = \frac{v_i^{\mathcal{B}}}{\|v_i^{\mathcal{B}}\|} \in \{\mathcal{B}\} \quad (5)$$

Assumption 1. (Attitude observability) At least two non-collinear vectors in Eq. (5) have to be accessible in order to establish the attitude of a rigid-body.

The orientation dynamics of a rigid-body are defined by

$$\dot{R} = R[\Omega]_\times \quad (6)$$

where Ω is the true angular velocity and its measurement is defined by

$$\Omega_m = \Omega + b + n \in \{\mathcal{B}\} \quad (7)$$

with $b \in \mathbb{R}^3$ being unknown constant bias and $n \in \mathbb{R}^3$ being unknown random noise. For more details visit [1,13]. Let \hat{R} denote the estimate of R . The aim attitude filters is to drive $\hat{R} \rightarrow R$ asymptotically as fast as possible. Accordingly, define the error between body-frame and estimator-frame as

$$\tilde{R} = R^\top \hat{R} \quad (8)$$

Additionally, define the error in bias estimation as

$$\tilde{b} = b - \hat{b} \quad (9)$$

C. Nonlinear Filter Design

Consider the estimate of $v_i^{\mathcal{B}}$ to be

$$\hat{v}_i^{\mathcal{B}} = \hat{R}^\top v_i^{\mathcal{I}} \quad (10)$$

Also, define

$$M^{\mathcal{B}} = \sum_{i=1}^n s_i R^\top v_i^{\mathcal{I}} (v_i^{\mathcal{I}})^\top R$$

Due to the fact that $[\alpha \times \beta]_{\times} = \beta\alpha^{\top} - \alpha\beta^{\top}, \forall \alpha, \beta \in \mathbb{R}^3$, one obtains

$$\begin{aligned} \left[\sum_{i=1}^n \frac{s_i}{2} \hat{v}_i^{\mathcal{B}} \times v_i^{\mathcal{B}} \right]_{\times} &= \sum_{i=1}^n \frac{s_i}{2} \left(v_i^{\mathcal{B}} (\hat{v}_i^{\mathcal{B}})^{\top} - \hat{v}_i^{\mathcal{B}} (v_i^{\mathcal{B}})^{\top} \right) \\ &= \frac{1}{2} R^{\top} M^{\mathcal{T}} R \tilde{R} - \frac{1}{2} \tilde{R}^{\top} R^{\top} M^{\mathcal{T}} R \\ &= \mathcal{P}_a(M^{\mathcal{B}} \tilde{R}) \end{aligned}$$

with the aid of Eq. (1), one has

$$\text{vex} \left(\mathcal{P}_a(M^{\mathcal{B}} \tilde{R}) \right) = \sum_{i=1}^n \frac{s_i}{2} \hat{v}_i^{\mathcal{B}} \times v_i^{\mathcal{B}} \quad (11)$$

where s_i denotes sensor confidence. Also, one can find [3,13]

$$\text{Tr} \left\{ \tilde{R} \right\} = \text{Tr} \left\{ \left(\sum_{i=1}^n s_i v_i^{\mathcal{B}} (v_i^{\mathcal{B}})^{\top} \right)^{-1} \sum_{i=1}^n s_i v_i^{\mathcal{B}} (\hat{v}_i^{\mathcal{B}})^{\top} \right\}$$

The filter design in this Section follows the structure in [4] where the contribution is the introducing adaptively tuned again rather than fixed gain. Consider the following filter design

$$\begin{cases} \dot{\hat{R}} = \hat{R} \left[\Omega_m - \hat{b} - W \right]_{\times}, & \hat{R}(0) = \hat{R}_0 \\ \dot{\hat{b}} = \frac{\gamma}{2} \text{vex}(\mathcal{P}_a(M^{\mathcal{B}} \tilde{R})) \\ W = \mathbf{K} \text{vex}(\mathcal{P}_a(M^{\mathcal{B}} \tilde{R})) \end{cases} \quad (12)$$

with $\mathbf{K} = 1 + k_{\text{op}} \in \mathbb{R}_+$, k_{op} being a positive constant to be designed in the following Section, γ being a positive constant, and \hat{b} being the estimates of b . One easily obtains [4]

$$\dot{M}^{\mathcal{B}} = -[\Omega]_{\times} M^{\mathcal{B}} + M^{\mathcal{B}} [\Omega]_{\times}$$

also

$$\dot{\tilde{R}} = \tilde{R} \left[\tilde{b} - W \right]_{\times}$$

Due to the fact that $\mathbf{K} \geq 1$ and recalling the identity in Eq. (3), the proof of stability in [4] holds for the filter in Eq. (12). Recall the identity in Eq. (3) and consider the following Lyapunov candidate function [4]

$$V = \text{Tr} \left(\mathbf{I}_3 - M^{\mathcal{B}} \tilde{R} \right) + \frac{1}{2\gamma} \tilde{b}^{\top} \tilde{b}$$

One has

$$\begin{aligned} \dot{V} &= -\text{Tr} \left\{ M^{\mathcal{B}} \dot{\tilde{R}} \right\} - \text{Tr} \left\{ M^{\mathcal{B}} \tilde{R} \right\} - \frac{1}{\gamma} \tilde{b}^{\top} \dot{\tilde{b}} \\ &= \frac{1}{2} \text{vex}(\mathcal{P}_a(M^{\mathcal{B}} \tilde{R}))^{\top} (\tilde{b} - W) - \frac{1}{\gamma} \tilde{b}^{\top} \dot{\tilde{b}} \\ &= -\frac{1}{2} \mathbf{K} \left\| \text{vex}(\mathcal{P}_a(M^{\mathcal{B}} \tilde{R})) \right\|^2 \end{aligned}$$

Remark 1. [3,13] *The classic design of nonlinear filters on SO(3) [4] selects the gain \mathbf{K} as a positive constant. The remarkable weakness of such approach is that smaller values of \mathbf{K} lead to slower transient performance with high measures of robustness in the steady-state (less oscillatory performance). On the other hand, greater value of \mathbf{K} results in faster transient performance with less robustness measures in the steady-state (higher oscillation).*

Motivated by the discussion in Remark 1, the objective is to find the optimal tuning strategy of the filter gain \mathbf{K} which could result in improving 1) the convergence capabilities and 2) robustness.

III. PROPOSED FILTER STRATEGY

According to Remark 1, \mathbf{K} has to be selected to be large enough at a large error and small enough at a small error. Therefore, fuzzy logic controller (FLC) will be employed to control the tuning of \mathbf{K} relative to the error in attitude. FLC consists of 1) fuzzification which include the input membership function, 2) rule base, and 3) defuzzification which includes the output membership function. To approach effective design of FLC, the parameters of input and output membership functions will be set using the artificial bee colony (ABC) algorithm.

A. Artificial Bee Colony

A global optimization approach, intended to imitate the natural behavior of a colony of bees, called the ABC algorithm was introduced in [16]. The algorithm has the colony split into three groups: scout bees are responsible for searching for new food (solution) sources, employed bees go to food sources and mark the position of the best one, and onlooker bees differentiate between good and bad sources brought to them by the employed bees. Scout bees are tasked with finding new sources of nectar with no regard to the quality of the food. Their only responsibility is to facilitate the search process. Employed bees, however, are searching for the best possible solution in an area, which they mark the location of, and communicate to the onlookers. The quantity of nectar is conveyed to the onlookers through a dance that, based on the duration and speed of shaking, allows them to differentiate between good and bad sources of food. Together, the employed and onlooker bees focus on finding the optimum source. The position within the search space of food sources is modeled as follows:

$$x_{ij}^{\text{new}} = x_{ij}^{\text{old}} + \alpha (x_{ij}^{\text{old}} - x_{kj}) \quad (13)$$

The quantity of nectar represents the objective function. The probability that onlooker bees will select a particular food source is modeled as below:

$$P_i = \frac{\mathcal{J}_i}{\sum_{i=1}^N \mathcal{J}_i}, \quad \forall i = 1, 2, \dots, N \quad (14)$$

The size of the colony is defined by $2N$, $j = 1, 2, \dots, P$ where P is the number of parameters that can be optimized. The related objective function of i th is \mathcal{J}_i , k is a random number among the colony size such that $k \in \{1, 2, \dots, N\}$, and α is a random number where $0 \leq \alpha \leq 1$. The ABC algorithm is depicted in Fig. 2.

B. Optimal Fuzzy-tuning of Nonlinear Attitude Filter

FLC uses heuristic and qualitative techniques to enable control of various applications, hence it is widely used. The development of FLC, in this work, is to manage nonlinear

TABLE I
RULE BASE OF FLC.

$\Delta e \backslash e$	<i>VL</i>	<i>L</i>	<i>M</i>	<i>S</i>	<i>VS</i>
<i>VL</i>	<i>VL</i>	<i>VL</i>	<i>VL</i>	<i>V</i>	<i>V</i>
<i>V</i>	<i>VL</i>	<i>VL</i>	<i>VL</i>	<i>V</i>	<i>M</i>
<i>M</i>	<i>VL</i>	<i>VL</i>	<i>V</i>	<i>M</i>	<i>M</i>
<i>S</i>	<i>VL</i>	<i>VL</i>	<i>M</i>	<i>M</i>	<i>S</i>
<i>VS</i>	<i>VL</i>	<i>VL</i>	<i>M</i>	<i>S</i>	<i>VS</i>

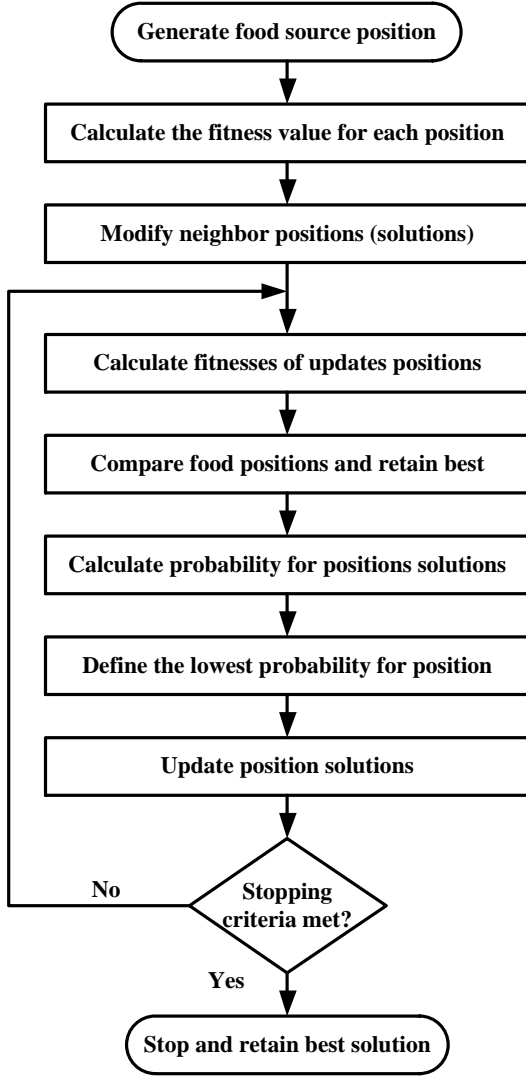

Fig. 2. Graphical illustration of ABC algorithm

attitude filter by fine tuning of the feedback filter gain. This tuning of filter would provide 1) fast convergence of attitude error and 2) improved robustness.

The key objective of this work is the construction of input and output membership functions for FLC, giving the capability to reduce error. Through the iterative process, the constraints of the input and output membership functions were chosen. The triangular membership functions of fuzzy inputs and output have five linguistic variables. These Linguistic variables are described as very large (*VL*), large (*L*), medium (*M*), small (*S*) and, very small (*VS*). The optimization of input and output membership function values are achieved using ABC in Subsection III-A. See the rule base of the proposed filter in Table I. The i th objective function is selected as below

$$\mathcal{J}_i = e_{tr} + e_{ss} = 0.3 \times \sum_{0 \leq t \leq 1} e(t) + \sum_{4 \leq t \leq 14} e(t) \quad (15)$$

Where e_{tr} refers to the transient time over the period of 0 to 1 seconds, while e_{ss} refers to the steady-state error over the period of 4 to 14 seconds for a sampling time of 0.01 seconds. Also, 0.3 is a weighting factor. These values were selected after a set of trials. The input and output membership functions have constraint values represented by Eq. (16) and Eq. (17), respectively. Each membership function is triangular and has three parameters.

$$\begin{cases} [0, 0, 0] & \leq [0, 0, k_1] \leq [0, 0, 0.15] \\ [0, 0, 0.1] & \leq [k_2, k_3, k_4] \leq [0.2, 0.2, 0.2] \\ [0.05, 0.1, 0.1] & \leq [k_5, k_6, k_7] \leq [0.2, 0.25, 0.35] \\ [0.1, 0.2, 0.2] & \leq [k_8, k_9, k_{10}] \leq [0.35, 0.5, 0.7] \\ [0.2, 1, 1] & \leq [k_{11}, 1, 1] \leq [0.7, 1, 1] \end{cases} \quad (16)$$

$$\begin{cases} [0, 0, 0] & \leq [0, 0, k_{12}] \leq [0, 0, 15] \\ [0, 5, 10] & \leq [k_{13}, k_{14}, k_{15}] \leq [20, 20, 30] \\ [5, 20, 20] & \leq [k_{16}, k_{17}, k_{18}] \leq [20, 50, 50] \\ [20, 20, 40] & \leq [k_{19}, k_{20}, k_{21}] \leq [50, 70, 90] \\ [40, 100, 100] & \leq [k_{22}, 100, 100] \leq [70, 100, 100] \end{cases} \quad (17)$$

where k_1 to k_{22} are parameters of the membership functions to be optimized using the ABC algorithm with respect to the objective function in Eq. (15) as well as the constraints in Eq. (16) and Eq. (17), respectively. Fig. 3 illustrates the complete diagram of the proposed filter strategy.

IV. RESULTS AND DISCUSSION

A. Attitude Measurements and Initialization

Consider the following set of measurements

$$\begin{cases} \Omega_m & = \Omega + b + n \text{ (rad/sec)} \\ \Omega & = [\sin(0.4t), \sin(0.7t + \frac{\pi}{4}), 0.4 \sin(0.3t + \frac{\pi}{2})]^\top \\ b & = 0.1 [-1, 1, 0.5]^\top, \quad n = \mathcal{N}(0, 0.2) \\ v_i^B & = R^\top v_i^T + b_i^B + n_i^B \\ v_1^T & = \frac{1}{\sqrt{3}} [1, -1, 1]^\top \\ b_1^B & = 0.1 [1, -1, 1]^\top, \quad n_1^B = \mathcal{N}(0, 0.05) \\ v_2^T & = [0, 0, 1]^\top \\ b_2^B & = 0.1 [0, 0, 1]^\top, \quad n_2^B = \mathcal{N}(0, 0.05) \\ v_3^B & = v_1^B \times v_2^B \end{cases}$$

where $n = \mathcal{N}(0, 0.2)$ is a random noise vector with 0 mean and standard deviation of 0.2. Also, for very large error,

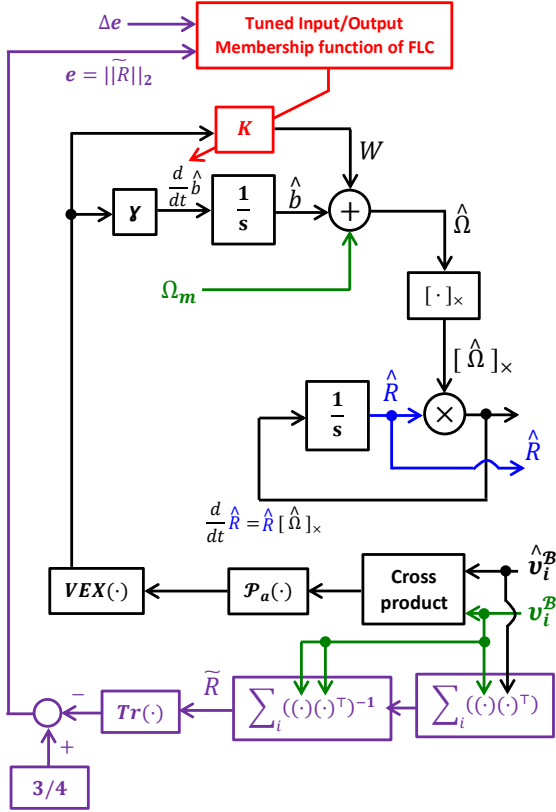

Fig. 3. Graphical illustration of the proposed filter strategy

consider the following initialization

$$R(0) = \mathbf{I}_3, \quad \hat{R}(0) = \begin{bmatrix} -0.0074 & 0.8557 & 0.5175 \\ 0.8802 & -0.2399 & 0.4094 \\ 0.4745 & 0.4586 & -0.7514 \end{bmatrix}$$

B. ABC Implementation

For implementation, Eq. (13) represents the position of the food source and Eq. (14) represents quality of the food. N is the number of sources to be visited. According to the ABC algorithm, N represents half of the colony size. The total number of iterations is 300. The number of sources to be visited in each iteration are $N = 100$. In every source visit, there are 22 parameters to be optimized k_1 to k_{22} given in Eq. (16) and (17). Fig. 4 and 5 illustrate the optimized input and output membership function after completing the search process.

C. Results of the Proposed Filter Strategy

Fig. 6 depicts smooth and fast convergence of the normalized Euclidean distance error $\|\tilde{R}\|_I = \frac{1}{4} \text{Tr} \{ \mathbf{I}_3 - R^\top \hat{R} \}$. It is obvious that $\|\tilde{R}\|_I$ started near the unstable equilibria and settled very close to the origin. The superiority of the proposed filter can be confirmed by Fig. 7. The true Euler angles (ϕ, θ, ψ) are plotted in Fig. 7 versus the estimated angles. Again, Fig. 7 illustrates robust performance of the proposed filter with superior convergence capabilities.

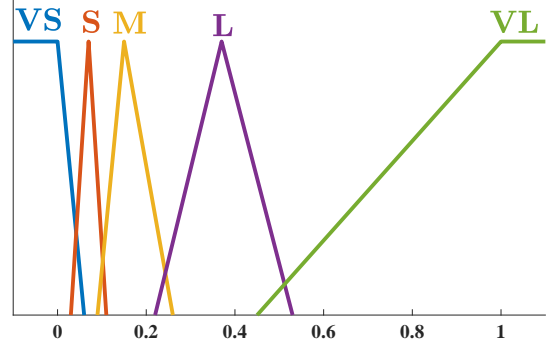

Fig. 4. Error and rate of error membership functions

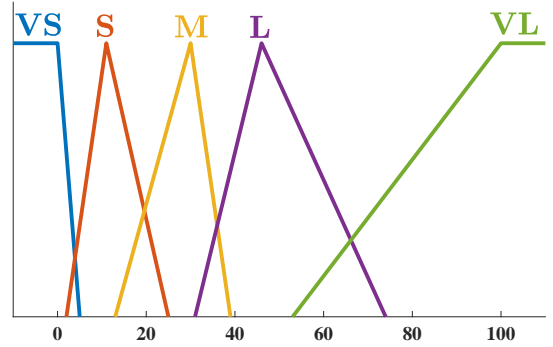

Fig. 5. Output membership function

V. CONCLUSION

This paper presents a new fuzzy logic controller (FLC) design for the adaptation gain of the nonlinear attitude filter. The artificial bee colony (ABC) optimization algorithm has been employed to determine the optimal variables of the input and output membership functions of the FLC. The proposed approach tunes the adaptation gain on-line, which in turn leads to fast adaptation. Additionally, because of the smooth tuning, the proposed filter maintains a high measure

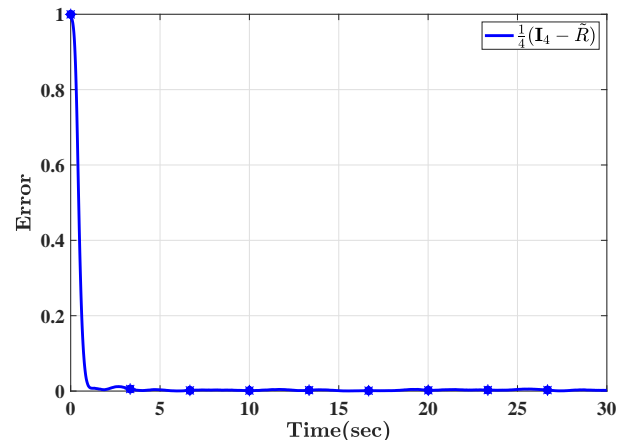

Fig. 6. Normalized Euclidean distance

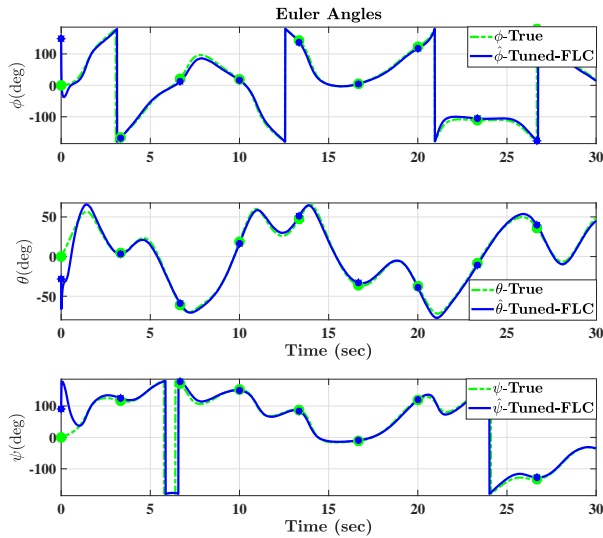

Fig. 7. Euler angles: True vs Estimate (Proposed)

of robustness. Numerical results reveal fast convergence of the attitude error and robustness of the proposed filter for the case of large initialization error and uncertain measurements. There are several directions for future work. The first direction is to implement the proposed approach on a real module and compare it against existing techniques in literature. The second direction is implementing recursive ABC for on-line implementation. To our knowledge, recursive ABC has not yet been explored within the area of attitude filters. The third direction is comparing ABC against other methods of evolutionary techniques.

ACKNOWLEDGMENT

The authors would like to thank **Maria Shaposhnikova** for proofreading the article.

REFERENCES

- [1] H. A. Hashim, L. J. Brown, and K. McIsaac, "Nonlinear stochastic attitude filters on the special orthogonal group 3: Ito and stratonovich," *IEEE Transactions on Systems, Man, and Cybernetics: Systems*, vol. 49, no. 9, pp. 1853–1865, 2019.
- [2] H. A. Hashim and F. L. Lewis, "Nonlinear stochastic estimators on the special euclidean group SE(3) using uncertain imu and vision measurements," *IEEE Transactions on Systems, Man, and Cybernetics: Systems*, vol. PP, no. PP, pp. 1–14, 2020.
- [3] H. A. Hashim, L. J. Brown, and K. McIsaac, "Guaranteed performance of nonlinear attitude filters on the special orthogonal group SO(3)," *IEEE Access*, vol. 7, no. 1, pp. 3731–3745, 2019.
- [4] R. Mahony, T. Hamel, and J.-M. Pflimlin, "Nonlinear complementary filters on the special orthogonal group," *IEEE Transactions on Automatic Control*, vol. 53, no. 5, pp. 1203–1218, 2008.
- [5] H. A. Hashim, L. J. Brown, and K. McIsaac, "Nonlinear explicit stochastic attitude filter on SO(3)," in *Proceedings of the 57th IEEE conference on Decision and Control (CDC)*, 2018, pp. 1210–1216.
- [6] F. L. Markley, "Attitude error representations for kalman filtering," *Journal of guidance, control, and dynamics*, vol. 26, no. 2, pp. 311–317, 2003.
- [7] H. A. H. Mohamed, "Nonlinear attitude and pose filters with superior convergence properties," *Ph. D, Western University*, 2019.
- [8] H. A. Hashim, "Guaranteed performance nonlinear observer for simultaneous localization and mapping," *IEEE Control Systems Letters*, vol. 5, no. 1, pp. 91–96, 2021.

- [9] M. D. Shuster and S. D. Oh, "Three-axis attitude determination from vector observations," *Journal of Guidance, Control, and Dynamics*, vol. 4, pp. 70–77, 1981.
- [10] F. L. Markley, "Attitude determination using vector observations and the singular value decomposition," *Journal of the Astronautical Sciences*, vol. 36, no. 3, pp. 245–258, 1988.
- [11] E. J. Lefferts, F. L. Markley, and M. D. Shuster, "Kalman filtering for spacecraft attitude estimation," *Journal of Guidance, Control, and Dynamics*, vol. 5, no. 5, pp. 417–429, 1982.
- [12] D. Choukroun, I. Y. Bar-Itzhack, and Y. Oshman, "Novel quaternion kalman filter," *IEEE Transactions on Aerospace and Electronic Systems*, vol. 42, no. 1, pp. 174–190, 2006.
- [13] H. A. Hashim, "Systematic convergence of nonlinear stochastic estimators on the special orthogonal group SO(3)," *International Journal of Robust and Nonlinear Control*, vol. 30, no. 10, pp. 3848–3870, 2020.
- [14] H. A. Hashim, S. El-Ferik, and M. A. Abido, "A fuzzy logic feedback filter design tuned with pso for L1 adaptive controller," *Expert Systems with Applications*, vol. 42, no. 23, pp. 9077–9085, 2015.
- [15] H. Shi, M. Xu, and K.-S. Hwang, "A fuzzy adaptive approach to decoupled visual servoing for a wheeled mobile robot," *IEEE Transactions on Fuzzy Systems*, 2019.
- [16] D. Karaboga and B. Basturk, "On the performance of artificial bee colony (abc) algorithm," *Applied soft computing*, vol. 8, no. 1, pp. 687–697, 2008.
- [17] A. E. Eltoukhy, Z. Wang, F. T. Chan, and X. Fu, "Data analytics in managing aircraft routing and maintenance staffing with price competition by a stackelberg-nash game model," *Transportation Research Part E: Logistics and Transportation Review*, vol. 122, pp. 143–168, 2019.
- [18] A. E. Eltoukhy, Z. Wang, F. T. Chan, S. Chung, H.-L. Ma, and X. Wang, "Robust aircraft maintenance routing problem using a turn-around time reduction approach," *IEEE Transactions on Systems, Man, and Cybernetics: Systems*, 2019.
- [19] A. E. Eltoukhy, Z. Wang, F. T. Chan, and S. H. Chung, "Joint optimization using a leader-follower stackelberg game for coordinated configuration of stochastic operational aircraft maintenance routing and maintenance staffing," *Computers & Industrial Engineering*, vol. 125, pp. 46–68, 2018.
- [20] Y. Yu, Z. Yang, C. Han, and H. Liu, "Fuzzy adaptive back-stepping sliding mode controller for high-precision deflection control of the magnetically suspended momentum wheel," *IEEE Transactions on Industrial Electronics*, vol. 65, no. 4, pp. 3530–3538, 2017.