

K-THEORETIC COULOMB BRANCHES OF QUIVER GAUGE THEORIES AND CLUSTER VARIETIES

GUS SCHRADER AND ALEXANDER SHAPIRO

ABSTRACT. Let \mathcal{A}_q be the K -theoretic Coulomb branch of a $3d \mathcal{N} = 4$ quiver gauge theory with quiver Γ , and $\mathcal{A}'_q \subseteq \mathcal{A}_q$ be the subalgebra generated by the equivariant K -theory of a point together with the dressed minuscule monopole operators $M_{\varpi_{i,1},f}$ and $M_{\varpi_{i,1}^*,f}$. In this paper, we construct an associated cluster algebra quiver Q_Γ and provide an embedding of the subalgebra \mathcal{A}'_q into the quantized algebra of regular functions on the corresponding cluster variety.

INTRODUCTION

In their recent work [Nak15, BFN16], Braverman, Finkelberg, and Nakajima have proposed a mathematical definition of the *Coulomb branch* of a $3d \mathcal{N} = 4$ SUSY gauge theory of cotangent type. Given a complex reductive group G and its complex representation N , they introduce a certain moduli space $\mathcal{R}_{G,N}$, which coincides with the affine Grassmannian Gr_G in the case N is trivial. It is shown in [BFN16] that there is a well-defined $G_{\mathcal{O}}$ -equivariant Borel-Moore homology $H_*^{G_{\mathcal{O}}}(\mathcal{R})$ of the moduli space \mathcal{R} , and that $H_*^{G_{\mathcal{O}}}(\mathcal{R})$ carries a convolution product which equips it with a commutative ring structure. The Coulomb branch \mathcal{M}_C is defined to be the spectrum of this ring:

$$\mathcal{M}_C = \text{Spec } H_*^{G_{\mathcal{O}}}(\mathcal{R}).$$

As a byproduct of the above definition, one obtains a *quantized Coulomb branch*. The latter is defined as the $G_{\mathcal{O}} \rtimes \mathbb{C}^*$ -equivariant homology of \mathcal{R} ,

$$\mathcal{M}_C^q = H_*^{G_{\mathcal{O}} \rtimes \mathbb{C}^*}(\mathcal{R}),$$

where \mathbb{C}^* acts by the *loop rotation* scaling the variable z in $\mathbb{C}[[z]]$. The algebra $H_*^{G_{\mathcal{O}} \rtimes \mathbb{C}^*}(\mathcal{R})$ is naturally a module over its commutative subalgebra $H_{G_{\mathcal{O}} \rtimes \mathbb{C}^*}^*(\text{pt})$.

Both the Coulomb branch and its quantization have K -theoretic counterparts, obtained by replacing equivariant homology with equivariant K -theory. From the physical point of view, K -theoretic Coulomb branches of $3d \mathcal{N} = 4$ SUSY gauge theories can be understood as the Coulomb branches of the $4d \mathcal{N} = 2$ theories compactified on a circle. It is the K -theoretic Coulomb branches and their quantizations that will concern us in the present text. If

$$\mathcal{A} = \text{Spec } K_{\bullet}^{G_{\mathcal{O}}}(\mathcal{R}) \quad \text{and} \quad \mathcal{A}_q = \text{Spec } K_{\bullet}^{G_{\mathcal{O}} \rtimes \mathbb{C}^*}(\mathcal{R}),$$

the K -theoretic Coulomb branch defined to be $\text{Spec}(\mathcal{A})$, and its quantization is the algebra \mathcal{A}_q itself. Similarly, to the homological case, the algebra \mathcal{A}_q is a module over its commutative subalgebra $K_{\bullet}^{G_{\mathcal{O}} \rtimes \mathbb{C}^*}(\text{pt})$.

An important class of Coulomb branches comes from quiver gauge theories, where the group G and the representation N arise from a (framed) representation of a quiver Γ . In a recent work [Wee19], Alex Weekes has proved that the quantized homological Coulomb branch $H_*^{G_{\mathcal{O}} \times \mathbb{C}^*}(\mathcal{R})$ is generated by the equivariant cohomology of a point $H_{G_{\mathcal{O}} \times \mathbb{C}^*}^*(\text{pt})$ together with the *dressed minuscule monopole operators* $M_{\varpi_{i,1},f}$ and $M_{\varpi_{i,1},f}^*$, where $\varpi_{i,1}$ is the first fundamental weight of the group $GL(V_i)$ of the i -th node of Γ . A similar result is expected to hold in the K -theoretic case, although at this point it has not been proven. In the present text we are concerned with the subalgebra $\mathcal{A}'_q \subseteq \mathcal{A}_q$, generated by $K_{G_{\mathcal{O}} \times \mathbb{C}^*}^*(\text{pt})$ and the K -theoretic dressed minuscule monopole operators $M_{\varpi_{i,1},f}$, $M_{\varpi_{i,1},f}^*$, leaving aside the question whether the algebras \mathcal{A}'_q and \mathcal{A}_q coincide.

It was suggested by Davide Gaiotto that the (quantized) K -theoretic Coulomb branch of a $3d \mathcal{N} = 4$ theory should carry a structure of a (quantum) cluster variety. The main result of this paper is the following partial result towards confirming Gaiotto's suggestion. Let Γ be a framed quiver without loops, but possibly with cycles of length > 1 . Set the group G to be the product

$$G = GL(V) \times T_F$$

of the gauge group $GL(V)$ of Γ and the *full torus of flavor symmetry*, see section 6. Then the subalgebra \mathcal{A}'_q of the corresponding K -theoretic Coulomb branch embeds into the quantized algebra of regular functions on a certain cluster variety. More precisely, given a quiver Γ for a quiver gauge theory, we construct an associated quiver Q_Γ , and consider the corresponding cluster-Poisson variety \mathcal{X} . We then exhibit an injective homomorphism from the algebra \mathcal{A}'_q into the quantum cluster chart of \mathcal{X} labelled by the quiver Q_Γ , and show that the images of the generators of the equivariant K -theory of a point, as well as those of minuscule monopole operators $M_{\varpi_{i,1},f}$, $M_{\varpi_{i,1},f}^*$, land inside the subalgebra of elements that are Laurent polynomials in any cluster, i.e. the quantized algebra of global functions on \mathcal{X} . The quiver Q_Γ is, roughly speaking, “glued” from the quivers encoding the cluster structure of the relativistic open Coxeter-Toda system for $GL(V_i)$, as i runs through the nodes of Γ . The appearance of the Toda lattice is natural due to its relation to the equivariant K -theory of the affine Grassmannian, see [BFM05, CW19].

Our proof is based on our earlier work [SS18], where we studied the cluster structure on the phase space of the open relativistic Coxeter-Toda system. In [SS18], we found new formulas for the so-called b -Whittaker functions, and proved that they form a complete set of eigenfunctions for the quantum Toda Hamiltonians. In other words, we have proved that the b -Whittaker transform, which diagonalizes the Toda Hamiltonians, is a unitary equivalence. Under the b -Whittaker transform the Toda Hamiltonians act via multiplication by symmetric functions in the spectral parameters of the b -Whittaker functions.

The quantized Coulomb branch \mathcal{A}_q can be embedded into an algebra of q -difference operators in variables $w_{i,n}$, where i runs through the nodes of Γ and $1 \leq n \leq \dim(V_i)$. Under this embedding, the equivariant K -theory of a point is generated by symmetric functions in variables $w_{i,\bullet}$, where i is fixed. Therefore, in order to construct an embedding $\mathcal{A}'_q \hookrightarrow \mathcal{O}_q(\mathcal{X})$, one needs to understand the action of the monopole operators

under the inverse b -Whittaker transform. Although the algebra \mathcal{A}_q does not depend on the orientation of the arrows in Γ up to isomorphism, the formulas for the minus-cule monopole operators do depend on the orientation, and so does our prescription for the cluster algebra quiver Q_Γ . It turns out, however, that all such cluster algebra quivers are elements of the same mutation class: there exists a sequence of mutations we call the *bi-fundamental Baxter operator* which realizes the effect of changing of the direction of a single arrow in the underlying gauge theory quiver Γ . In other words, different orientations of Γ determine different points in the cluster modular groupoid of the same cluster variety \mathcal{X} . At the same time, the formula for $M_{\varpi_{i,1},f}$ (respectively, $M_{\varpi_{i,1}^*,f}$) takes the simplest form when the node $i \in \Gamma$ is a sink (respectively, a source), and in this case we can easily compute their inverse b -Whittaker transform as certain cluster monomials, which are universally Laurent thanks to the quantum Laurent phenomenon.

Let us conclude the introduction by mentioning the forthcoming paper of S. Cautis and H. Williams, in which they construct a finite-length t -structure on the derived category of $G_{\mathcal{O}}$ -equivariant coherent sheaves on the moduli space \mathcal{R} such that the convolution functor is t -exact. This leads to a canonical basis in the K -theoretic Coulomb branch algebra and a potential monoidal categorification of the cluster structure discussed in the present article; it would be interesting to explore the latter possibility further.

ACKNOWLEDGEMENTS

We are very grateful to Alexander Braverman, Philippe Di Francesco, Michael Finkelberg, Michael Gekhtman, Rinat Kedem, Hiraku Nakajima, Michael Shapiro, Alexander Tsybaliuk, Alex Weekes, and Harold Williams for many helpful discussions and explanations. The second author has been supported by the NSF Postdoctoral Fellowship DMS-1703183.

1. NON-COMPACT QUANTUM DILOGARITHMS

In this section, we fix our conventions and recall the necessary cluster algebraic machinery. For the rest of the paper we set

$$c_b = \frac{i(b + b^{-1})}{2} \quad \text{for} \quad b \in \mathbb{R}_{>0}$$

and define

$$\zeta = e^{\pi i(1-4c_b^2)/12} \quad \text{and} \quad \zeta_{\text{inv}} = \zeta^{-2} e^{-\pi i c_b^2}.$$

Definition 1.1. Let C be the contour going along the real line from $-\infty$ to $+\infty$, surpassing the origin in a small semi-circle from above. The *non-compact quantum dilogarithm function* $\varphi_b(z)$ is defined in the strip $|\Im(z)| < |\Im(c_b)|$ by the following formula [Kas01]:

$$\varphi_b(z) = \exp \left(\frac{1}{4} \int_C \frac{e^{-2izt}}{\sinh(tb) \sinh(tb^{-1})} \frac{dt}{t} \right).$$

The non-compact quantum dilogarithm can be analytically continued to the entire complex plane as a meromorphic function with an essential singularity at infinity. The

resulting function $\varphi_b(z)$ enjoys many remarkable properties, see [FK94, Kas01, FG09a]. Those, most important for the present paper, are as follows:

modular duality:

$$\varphi_b(z) = \varphi_{b^{-1}}(z);$$

inversion formula:

$$\varphi_b(z)\varphi_b(-z) = \zeta_{\text{inv}} e^{\pi i z^2}; \quad (1.1)$$

functional equations:

$$\varphi_b(z - ib^{\pm 1}/2) = \left(1 + e^{2\pi b^{\pm 1}z}\right) \varphi_b(z + ib^{\pm 1}/2); \quad (1.2)$$

unitarity:

$$\overline{\varphi_b(z)}\varphi_b(\bar{z}) = 1; \quad (1.3)$$

pentagon identity: given a pair of self-adjoint operators p and x we have:

$$[p, x] = \frac{1}{2\pi i} \quad \text{implies} \quad \varphi_b(p)\varphi_b(x) = \varphi_b(x)\varphi_b(p+x)\varphi_b(p). \quad (1.4)$$

In what follows we will drop the subscript b from the notation for the quantum dilogarithm, and simply write $\varphi(z)$. The next lemma follows from equations (1.2).

Lemma 1.2. *For self-adjoint operators p and x satisfying $[p, x] = \frac{1}{2\pi i}$, we have*

$$\begin{aligned} \varphi(x)^{-1} e^{2\pi b^{\pm 1}p} \varphi(x) &= e^{2\pi b^{\pm 1}p} + e^{2\pi b^{\pm 1}(p+x)}, \\ \varphi(p) e^{2\pi b^{\pm 1}x} \varphi(p)^{-1} &= e^{2\pi b^{\pm 1}x} + e^{2\pi b^{\pm 1}(p+x)}. \end{aligned}$$

Notation 1.3. In the paper, we will sometimes consider contour integrals of the form

$$\int_C \prod_{j,k} \frac{\varphi(t - a_j)}{\varphi(t - b_k)} f(t) dt,$$

where $f(t)$ is some entire function. Unless otherwise specified, the contour C in such an integral is always chosen to be passing below the poles of $\varphi(t - a_j)$ for all j , above the poles of $\varphi(t - b_k)^{-1}$ for all k , and escaping to infinity in such a way that the integrand is rapidly decaying.

The quantum dilogarithm enjoys the Fourier transform formulas:

$$\zeta\varphi(w) = \int \frac{e^{2\pi i x(w - c_b)}}{\varphi(x - c_b)} dx, \quad (1.5)$$

$$\frac{1}{\zeta\varphi(w)} = \int \frac{\varphi(x + c_b)}{e^{2\pi i x(w + c_b)}} dx. \quad (1.6)$$

Note that in accordance with Notation 1.3, the integration contours in (1.5) and (1.6) can be taken to be $\mathbb{R} + i0$ and $\mathbb{R} - i0$ respectively, where we write $\mathbb{R} \pm i0$ instead of $\mathbb{R} \pm i\varepsilon$ with a sufficiently small positive number ε .

The Fourier transform formulas (1.5) or (1.6) allows one to interpret the expression $\varphi(p)$ as an integral operator acting on $L^2(\mathbb{R})$. Indeed, for any $u \in \mathbb{R}$ we write

$$\begin{aligned}\varphi(p+u)f(x) &= \zeta^{-1} \int \frac{e^{2\pi it(p+u-c_b)}}{\varphi(t-c_b)} f(x) dt \\ &= \zeta^{-1} \int \frac{e^{2\pi it(u-c_b)}}{\varphi(t-c_b)} f(x+t) dt.\end{aligned}$$

Shifting the integration variable $t \rightarrow t-x$, we obtain

$$\varphi(p+u)f(x) = \zeta^{-1} e^{2\pi i x(c_b-u)} \int \frac{e^{2\pi it(u-c_b)}}{\varphi(t-x-c_b)} f(t) dt. \quad (1.7)$$

Remark 1.4. This latter formula allows us to define the action of $\varphi(p+u)$ on a test function when the parameter u is no longer constrained to the real line. In the sequel, all operators of the form $\varphi(a+u)$ where a is self-adjoint and $u \notin \mathbb{R}$ are to be understood in this sense, as operators on the appropriate space of test functions.

Proposition 1.5. *If the function $f(\mathbf{x})$ is such that $p_n f(\mathbf{x}) = \lambda f(\mathbf{x})$, then*

$$\varphi(p_n + x_n + w) \varphi(2p_n + x_n + w + c_b - \lambda) f(\mathbf{x}) = f(\mathbf{x})$$

for any operator w satisfying $[p_n, w] = 0$.

Proof. Note that the Fourier transform (1.5) yields

$$\varphi(2p_n + x_n + w + c_b - \lambda) f(\mathbf{x}) = \zeta^{-1} \int \frac{e^{2\pi it(2p_n + x_n + w - \lambda)}}{\varphi(t - c_b)} f(\mathbf{x}) dt.$$

Now, we can rewrite the right hand side as

$$\zeta^{-1} \int \frac{e^{\pi it^2} e^{2\pi it(p_n + x_n + w - \lambda)} e^{2\pi it p_n}}{\varphi(t - c_b)} f(\mathbf{x}) dt = \zeta^{-1} \int \frac{e^{\pi it^2} e^{2\pi it(p_n + x_n + w)}}{\varphi(t - c_b)} f(\mathbf{x}) dt$$

where we use that $p_n f(\mathbf{x}) = \lambda f(\mathbf{x})$. Changing the sign of the integration variable and using the inversion formula for the quantum dilogarithm, we see that the right hand side takes form

$$\zeta \int e^{-2\pi it(p_n + x_n + w + c_b)} \varphi(t + c_b) f(\mathbf{x}) dt = \varphi(p_n + x_n + w)^{-1} f(\mathbf{x}).$$

The latter equality follows from the Fourier transform (1.6). \square

Definition 1.6. The c -function is a meromorphic function with an essential singularity at infinity, defined by the following formula:

$$c(z) = \zeta^{-1} \varphi(z - c_b)^{-1} e^{\frac{\pi i}{2} z(z - 2c_b)}.$$

The above definition implies the following properties of the $c(z)$:

Inversion formula:

$$c(z)c(2c_b - z) = 1.$$

Functional equations:

$$c(z + ib^{\pm 1}) = \left(e^{-\pi b^{\pm 1} z} - e^{\pi b^{\pm 1} z} \right) ic(z).$$

Complex conjugation:

$$\overline{c(z)} = c(-\bar{z}).$$

2. QUANTUM CLUSTER ALGEBRA

In this section we recall a few basic facts about quantum cluster algebras and their positive representations, following [FG09a, FG09b].

2.1. Seeds, tori, mutations. We shall only need the quantum cluster algebras related to quantum groups of type A, and we incorporate this in the definition of a cluster seed.

Definition 2.1. A cluster seed is a datum $\Theta = (\Lambda, (\cdot, \cdot), \{e_i \mid i \in I\}, I_0 \subset I)$ where

- Λ is a lattice;
- $\{e_i \mid i \in I\}$ is a basis of the lattice Λ ;
- I_0 is a subset of I , vectors $\{e_i \mid i \in I_0\}$ are called the frozen basis vectors;
- (\cdot, \cdot) is a skew-symmetric $\mathbb{Z}/2$ -valued form on Λ , such that $(e_i, e_j) \in \mathbb{Z}$ unless $i, j \in I_0$.

Remark 2.2. In the above definition we set all multipliers $d_i = 1$.

To a seed Θ , we can associate a quiver \mathcal{Q} with vertices labelled by the set I , a subset of frozen vertices labelled by I_0 , and arrows given by the adjacency matrix $\varepsilon = (\varepsilon_{ij})$, such that $\varepsilon_{ij} = (e_i, e_j)$. It is clear, that the seed can be restored from a quiver. Indeed, a vertex $i \in I$ corresponds to the basis vector e_i , which gives rise to a lattice as i runs through I , while the adjacency matrix of the quiver defines the form (\cdot, \cdot) .

The pair $(\Lambda, (\cdot, \cdot))$ determines a *quantum torus algebra* \mathcal{T}_Λ , which is the free $\mathbb{Z}[q^{\pm 1}]$ -module spanned by the symbols $Y(\lambda)$, $\lambda \in \Lambda$, with the multiplication defined by

$$q^{(\lambda, \mu)} Y(\lambda) Y(\mu) = Y(\lambda + \mu),$$

so that $Y(0) = 1$ is the unit element. A basis $\{e_i\}$ of the lattice Λ gives rise to a distinguished system of generators for \mathcal{T}_Λ , namely the elements $Y_i = Y(e_i)$. Equivalently, for each seed Θ , we have a quantum torus algebra

$$\mathcal{X}_\Theta^q = \mathbb{Z}[q^{\pm 1}] \langle Y_1^{\pm 1}, \dots, Y_n^{\pm 1} \rangle,$$

called the *quantum cluster chart*, together with an isomorphism $\mathcal{X}_\Theta^q \simeq \mathcal{T}_\Lambda$ given by $Y_i = Y(e_i)$. The generators Y_i are called the *cluster \mathcal{X} -coordinates*. Given the algebra \mathcal{T}_Λ one can consider an associated Heisenberg $*$ -algebra \mathcal{H}_Λ . It is a topological $*$ -algebra over \mathbb{C} generated by elements $\{y_i\}$ satisfying

$$[y_j, y_k] = \frac{1}{2\pi i} \varepsilon_{jk} \quad \text{and} \quad * y_j = y_j.$$

Then the assignments

$$Y_j = e^{2\pi b y_j} \quad \text{and} \quad q = e^{\pi i b^2}$$

define a homomorphism of algebras $\iota_\Lambda: \mathcal{T}_\Lambda \hookrightarrow \mathcal{H}_\Lambda$.

The *modular dual* \mathcal{T}_Λ^\vee to the quantum torus \mathcal{T}_Λ is the algebra identical¹ to \mathcal{T}_Λ , except the generators Y_j and the variable q are replaced by Y_j^\vee and q^\vee respectively. Then the

¹In general, if the form (\cdot, \cdot) is skew-symmetrizable but not skew-symmetric, the two algebras differ.

assignments

$$Y_j^\vee = e^{2\pi b^{-1}y_j} \quad \text{and} \quad q^\vee = e^{\pi i b^{-2}}$$

define an embedding of algebras $\iota_\Lambda^\vee: \mathcal{T}_\Lambda^\vee \hookrightarrow \mathcal{H}_\Lambda$. Note that the following commutation relation holds in \mathcal{H}_Λ :

$$Y_j Y_k^\vee = e^{-2\pi i \varepsilon_{jk}} Y_k^\vee Y_j. \quad (2.1)$$

and thus Y_j and Y_k^\vee commute whenever $\varepsilon_{jk} \in \mathbb{Z}$.

Let Θ be a seed, and $k \in I$ a vertex of the corresponding quiver \mathcal{Q} . Then one obtains a new seed, $\mu_k(\Theta)$, called the *mutation of Θ in direction k* , by changing the basis $\{e_i\}$ while the rest of the data remains the same. The new basis $\{e'_i\}$ is

$$e'_i = \begin{cases} -e_k & \text{if } i = k, \\ e_i + [\varepsilon_{ik}]_+ e_k & \text{if } i \neq k, \end{cases} \quad (2.2)$$

where $[a]_+ = \max(a, 0)$. We remark that the bases $\{e_i\}$ and $\{\mu_k^2(e_i)\}$ do not necessarily coincide, although the seeds Θ and $\mu_k^2(\Theta)$ are isomorphic.

For each mutation μ_k we define an algebra automorphism of skew fields $\text{Frac}(\mathcal{T}_\Lambda)$ and $\text{Frac}(\mathcal{T}_\Lambda^\vee)$:

$$\mu_k = \text{Ad}_{\varphi^{-1}(-y_k)}.$$

By abuse of notation we call this automorphism a *quantum mutation* and denote it by the same symbol μ_k . The fact that conjugation by $\varphi^{-1}(-y_k)$ yields a genuine birational automorphism of \mathcal{T}_Λ and \mathcal{T}_Λ^\vee is guaranteed by the integrality of the form (\cdot, \cdot) and functional equations (1.2). For example, the statement of the Lemma 1.2 is equivalent to

$$\mu_k(Y_{e_i}) = \begin{cases} Y_{e'_i} (1 + qY_{e'_k}) & \text{if } \varepsilon_{ki} = 1, \\ Y_{e'_i} (1 + qY_{e'_k}^{-1})^{-1} & \text{if } \varepsilon_{ki} = -1, \end{cases}$$

and an identical equality for $Y_{e_j}^\vee$ and q^\vee .

An element $t \in \mathcal{T}_\Lambda$ is said to be *universally Laurent* if $\mu(t) \in \mathcal{T}_\Lambda$ for any finite sequence μ of quantum mutations at *mutable* vertices, that is $\mu = \mu_{i_r} \dots \mu_{i_1}$ with $i_1, \dots, i_r \in I \setminus I_0$. Equivalently, an element is universally Laurent if it is a Laurent polynomial in cluster coordinates of any quantum cluster chart. Now, we define $\mathbb{L} \subset \mathcal{T}_\Lambda$ and $\mathbb{L}^\vee \subset \mathcal{T}_\Lambda^\vee$ to be the subalgebras of universally Laurent elements, and $\mathbf{L} \subset \mathcal{H}_\Lambda$ to be the subalgebra generated by \mathbb{L} and \mathbb{L}^\vee . Note that if $\varepsilon_{ij} \in \mathbb{Z}$ for all $i, j \in I$ and $b^2 \in \mathbb{R} \setminus \mathbb{Q}$, then

$$\mathbf{L} = \mathbb{L} \otimes_{\mathbb{Z}} \mathbb{L}^\vee.$$

Let M be an $|I| \times |I|$ matrix with $M_{ij} = 0$ unless both i and j are frozen and such that $\tilde{\varepsilon} = \varepsilon + M \in GL_{|I|}(\mathbb{Z})$. Denote the inverse of $\tilde{\varepsilon}$ by v . Then, to every seed Θ we can associate a quantum torus

$$\mathcal{A}_\Theta^q = \mathbb{Z}[q^{\pm 1}] \langle A_1^{\pm 1}, \dots, A_n^{\pm 1} \rangle,$$

called the *quantum cluster \mathcal{A} -chart*, together with an isomorphism $\mathcal{A}_\Theta^q \simeq \mathcal{T}_\Lambda$ defined by

$$A_k = Y(a_k), \quad \text{where} \quad a_k = \sum_{i \in I} v_{ik} e_i. \quad (2.3)$$

The elements A_k are called the *quantum cluster \mathcal{A} -variables*, they satisfy the following commutation relations:

$$A_i A_j = q^{2v_{ij}} A_j A_i.$$

Mutations between the quantum cluster \mathcal{A} -charts can be defined by the formula (4.23) in [BZ05], then the assignment (2.3) intertwines cluster mutations for the \mathcal{A} - and \mathcal{X} -charts. In what follows, unless otherwise specified, we will write “cluster charts” and “cluster variables” for quantum cluster \mathcal{X} -charts and quantum cluster \mathcal{X} -variables. Finally, let us recall that if $\tilde{\varepsilon}$ is invertible, that is $\det(\tilde{\varepsilon}) = \pm 1$, the algebra \mathbf{L} is nothing but the *upper cluster algebra*, and all quantum cluster \mathcal{A} -variables are universally Laurent.

2.2. Representations. In [FG09b], a family of $*$ -representations of the algebra \mathbf{L} was constructed, which we now recall. Let Θ be a cluster seed, and Λ the corresponding lattice. We write $\Lambda_{\mathbb{R}} = \Lambda \otimes_{\mathbb{Z}} \mathbb{R}$, and set $Z \subset \Lambda_{\mathbb{R}}$ to be the kernel of the skew form (\cdot, \cdot) . The algebra \mathcal{H}_{Λ} has a family of irreducible $*$ -representations V^{λ} parameterized by its central characters λ , where the generators y_j act by unbounded operators in a Hilbert space.

In order to obtain an explicit realization of V^{λ} one can pick a symplectic basis $(p_j, x_j)_{j=1}^n$ in the symplectic vector space $\Lambda_{\mathbb{R}}/Z$. This induces an algebra homomorphism

$$\mathcal{H}_{\Lambda} \rightarrow \frac{\mathbb{C} \langle p_j, x_j \rangle_{j=1}^n}{\langle [p_j, x_k] = \frac{\delta_{jk}}{2\pi i}, 1 \leq j, k \leq n. \rangle},$$

Choosing a label homomorphism induces a representation of the algebra \mathcal{H}_{Λ} on the Hilbert space $L_2(\mathbb{R}^n, d\mathbf{x})$ in which the generators x_j act by coordinate multiplication while the p_j act by derivatives $\partial/\partial x_j$. The representations corresponding to different choices of label homomorphism are unitarily equivalent, the intertwiners being provided by the action of the metaplectic group $\text{Mp}(\Lambda_{\mathbb{R}}/Z)$.

The $*$ -representation V^{λ} of the Heisenberg algebra \mathcal{H}_{Λ} restricts to \mathbf{L} via the embedding $\mathbf{L} \subset \mathcal{H}_{\Lambda}$. Elements $A \in \mathbf{L}$ (as well as the generators $x_j \in \mathcal{H}_{\Lambda}$) act on V^{λ} by unbounded and thus only densely defined operators \widehat{A} . Let us now describe their joint domain $\mathcal{S} \subset V^{\lambda}$, following [FG09b].

Consider the space $\mathcal{F} \subset L^2(\mathbb{R})$ consisting of entire functions f such that

$$\int_{\mathbb{R}} e^{xs} |f(x + iy)|^2 dx < \infty \quad \text{for all } s, y \in \mathbb{R}.$$

The space \mathcal{F} is dense in $L^2(\mathbb{R})$, as can be seen from that fact that it contains the subspace

$$\mathcal{F}_0 = \left\{ e^{-\alpha x^2 + \beta x} p(x) \mid \alpha \in \mathbb{R}_{>0}, \beta \in \mathbb{C}, p(x) \in \mathbb{C}[x] \right\}.$$

So the tensor product $\mathcal{F}^n = \bigotimes_{k=1}^n \mathcal{F}$ is a subspace of V^{λ} .

Definition 2.3. The *Fock–Goncharov Schwartz space* \mathcal{S}^{λ} of the algebra \mathbf{L} is the subspace of V^{λ} consisting of all vectors $f \in V^{\lambda}$ for which the functional

$$\mathcal{F}^n \longrightarrow \mathbb{R}, \quad w \mapsto \langle f, Aw \rangle$$

is continuous in the L^2 -norm for all $A \in \mathbf{L}$.

The Schwartz space \mathcal{S}^λ is the common domain of definition of the operators from \mathbf{L} . It has a topology given by the family of semi-norms $\|Af\|_{L^2}$ where A runs over a basis in \mathbf{L} . Thus, we obtain a $*$ -representation of \mathbf{L} on the Fréchet subspace \mathcal{S} of the Hilbert space V^λ .

Definition 2.4. A tuple $(\mathbf{L}, \mathcal{S})$ as above is called a *positive representation* of the algebra \mathbf{L} .

The reason for this terminology comes from the fact that the quantum cluster variables Y_j act by positive operators on the Hilbert space V^λ . Let us also recall that any generator $y_j \in \mathcal{H}_\Lambda$ acts on the Hilbert space V^λ by a self-adjoint operator. Thus, in view of the property (1.3) of the non-compact quantum dilogarithm function, $\varphi(y_k)$ is a unitary operator on the Hilbert space V^λ . The following result is a weaker version of [FG09b, Theorem 5.4].

Theorem 2.5. For any finite sequence of cluster mutations μ , the corresponding unitary quantum mutation operators $\widehat{\mu}_q: V^\lambda \rightarrow V^\lambda$ preserves the Schwartz space \mathcal{S} . Moreover, for any $A \in \mathbf{L}$ and $s \in \mathcal{S}$, we have

$$\widehat{\mu}_q \widehat{A} \widehat{\mu}_q^{-1} s = \widehat{\mu}_q(A) s.$$

3. QUANTUM COXETER-TODA SYSTEMS

Here we recall the cluster structure on the quantized relativistic open Coxeter-Toda system, as presented in [SS18].

3.1. Baxter operators.

Definition 3.1. For $n \geq 2$, we define a quiver \mathcal{Q}_n with $2n$ vertices $\{v_0, \dots, v_{2n-1}\}$ and the following arrows:

- for all $1 \leq k \leq n - 1$ there is a double arrow $v_{2k} \rightrightarrows v_{2k-1}$;
- for all $1 \leq k \leq n$ there is an arrow $v_{2k-1} \rightarrow v_{2k-2}$;
- for all $1 \leq k \leq n - 2$ there is an arrow $v_{2k-1} \rightarrow v_{2k+2}$;
- there are additional arrows $v_0 \rightarrow v_2$ and $v_{2n-3} \rightarrow v_{2n-1}$.

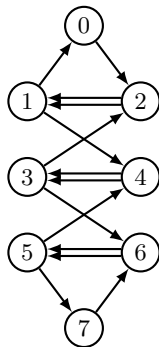

FIGURE 1. The quiver \mathcal{Q}_4 .

Consider the quiver \mathcal{Q}_n (illustrated in Figure 1 for the $n = 4$ case), and the corresponding cluster seed together with its Heisenberg $*$ -algebra \mathcal{H}_n .

We will abuse notation once again and denote certain elements of the Heisenberg algebra by the same symbols $\{v_0, \dots, v_{2n-1}\}$ as the vertices of the Coxeter quiver.

For any choice of *spectral parameters* $u, v \in \mathbb{R}$, the assignment

$$\begin{aligned} v_0 &= -p_1 - u, & v_{2j-1} &= p_j - p_{j+1} + x_j - x_{j+1}, \\ v_{2j} &= x_{j+1} - x_j, & v_{2n-1} &= p_n + v \end{aligned} \quad (3.1)$$

where $j = 1, \dots, n-1$ defines a label homomorphism in the sense of Section 2.2, and thus gives rise to a representation of \mathcal{H}_n on the Hilbert space of L^2 -functions in the variables x_1, \dots, x_n , in which the elements v_j of \mathcal{H}_n act by unbounded self-adjoint² operators. Note that the quiver \mathcal{Q}_n is completely determined by the images of the elements $\{v_0, \dots, v_{2n-1}\}$ under the label homomorphism (3.1). In what follows, we will often define new quivers by specifying the elements of the corresponding Heisenberg algebra.

Definition 3.2. We define the (top) *Baxter Q -operator* $Q_n(u)$ to be the operator whose inverse is the composition of consecutive mutations μ_k at vertices $v_0, v_1, \dots, v_{2n-2}$ in the quiver \mathcal{Q}_n :

$$Q_n(u)^{-1} = \mu_{2n-2} \dots \mu_1 \mu_0.$$

Similarly, we define the (bottom) *Baxter Q -operator* $\tilde{Q}_n(u)$:

$$\tilde{Q}_n(u)^{-1} = \mu_2 \mu_1 \dots \mu_{2n-2} \mu_{2n-3} \mu_{2n-1}.$$

Both Baxter Q -operators can be described explicitly by the following formulas:

$$\begin{aligned} Q_1(u) &= \varphi(p_1 + u), & Q_n(u) &= Q_1(u) T_2(u) \dots T_n(u), \\ \tilde{Q}_1(v) &= \varphi(-p_1 - v), & \tilde{Q}_n(v) &= \tilde{T}_n(v) \dots \tilde{T}_2(v) \tilde{Q}_1(v), \end{aligned}$$

where

$$\begin{aligned} T_k(u) &= \varphi(p_k + x_k - x_{k-1} + u) \varphi(p_k + u), \\ \tilde{T}_k(v) &= \varphi(-p_k - v) \varphi(-p_{k-1} + x_k - x_{k-1} - v). \end{aligned}$$

Note that the following renumbering of variables

$$v_0 \leftrightarrow v_{2n-1} \quad \text{and} \quad v_{2j} \leftrightarrow v_{2(n-j)}, \quad v_{2j-1} \leftrightarrow v_{2(n-j)-1} \quad \text{for} \quad 1 \leq j \leq n-1.$$

gives an automorphism of the quiver \mathcal{Q}_n . The above renumbering is equivalent to an involution ϑ_n of the algebra $\mathcal{H}_n \otimes \mathbb{C}[u, v]$ given by

$$x_j \leftrightarrow -x_{n+1-j}, \quad p_j \leftrightarrow -p_{n+1-j}, \quad u \leftrightarrow -v, \quad (3.2)$$

where we understand u and v as formal parameters. It is straightforward to check that the involution ϑ_n intertwines the top and bottom Baxter operators:

$$Q_n(u) \circ \vartheta_n = \vartheta_n \circ \tilde{Q}_n(v).$$

At the level of quivers, the effect of the top Baxter operator mutation sequence is to transport the “handle” vertex v_0 at the top of the Coxeter quiver down to create a new

²We can relax the reality condition on the spectral parameters and allow $u, v \in \mathbb{C}$ at the cost of losing the self-adjointness of the v_j .

handle at the bottom of the quiver. The quiver \mathcal{Q}'_n obtained from \mathcal{Q}_n by applying this sequence is illustrated in Figure 2. Similarly, the bottom Baxter operator transport vertex v_{2n-1} to the top of the Coxeter quiver.

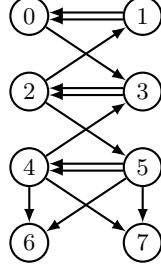

FIGURE 2. The quiver \mathcal{Q}'_4 .

Let us also recall a few facts about the Dehn twist operator τ_n from [SS18]. The operator D_n is defined by

$$\tau_n = \zeta_{\text{inv}}^n \tilde{Q}_n(0)^{-1} Q_n(0)^{-1}$$

and therefore commutes with Baxter operators. Equivalently, one can write the Dehn twist as

$$\tau_n = \pi_{\text{Dehn}} \circ \prod_{k=1}^{n-1} \mu_{2k-1},$$

where the permutation π_{Dehn} is the product of transpositions $v_{2k} \leftrightarrow v_{2k-1}$ as k runs from 1 to $n - 1$. The latter formula is spelled out as follows:

$$\tau_n = \prod_{j=1}^{n-1} \varphi(x_{j+1} - x_j)^{-1} \prod_{j=1}^n e^{-\pi i p_j^2}.$$

3.2. Toda Hamiltonians. The following proposition has been proven in [SS18].

Proposition 3.3.

(1) *Baxter operators commute: for any u, v we have*

$$[Q(u), Q(v)] = [Q(u), \tilde{Q}(v)] = [\tilde{Q}(u), \tilde{Q}(v)] = 0$$

(2) *Additionally, there are relations*

$$Q_n(u - ib/2) Q_n(u + ib/2)^{-1} = \sum_{k=0}^n H_k^{(n)} e^{2\pi b k u},$$

$$\tilde{Q}_n(u - ib/2) \tilde{Q}_n(u + ib/2)^{-1} = \sum_{k=0}^n \tilde{H}_k^{(n)} e^{-2\pi b k u},$$

where $H_k^{(n)}, \tilde{H}_k^{(n)} \in \mathbb{C} \langle e^{\pm 2\pi b x_j}, e^{\pm 2\pi b p_j} \rangle_{j=1, \dots, n}$, and the following holds:

$$\tilde{H}_k^{(n)} = (H_n^{(n)})^{-1} H_{n-k}^{(n)}.$$

Proposition 3.3 ensures that the operators $H_k^{(n)}$ commute for fixed n :

$$\left[H_k^{(n)}, H_l^{(n)} \right] = 0 \quad \text{for} \quad 0 \leq k, l \leq n.$$

These operators are known under the name of quantum \mathfrak{gl}_n -Toda Hamiltonians. Indeed, they can be viewed as quantized Hamiltonians of the open relativistic Coxeter-Toda integrable system, whose phase space is a reduced double Coxeter Bruhat cell in GL_n . Alternatively, the quantum Toda Hamiltonians can be defined via relation

$$H_k^{(n+1)} = H_k^{(n)} + e^{2\pi b p_{n+1}} H_{k-1}^{(n)} + e^{2\pi b(p_{n+1} + x_{n+1} - x_n)} H_{k-1}^{(n-1)}$$

if one sets

$$H_0^{(0)} = 1 \quad \text{and} \quad H_k^{(n)} = 0 \quad \text{unless} \quad 0 \leq k \leq n.$$

Proposition 3.4. *The quantum \mathfrak{gl}_n -Toda Hamiltonians along with the element κ are universally Laurent in the cluster structure defined by the quiver \mathcal{Q}_n .*

Proof. Let us augment the quiver \mathcal{Q}_n with a mutable vertex v_a and a frozen vertex v_f with labels

$$v_a = -p_1 - x_0, \quad v_f = p_0.$$

We denote the resulting quiver $\widehat{\mathcal{Q}}_n$, see Figure 4. First of all, let us note that the element $X_f := X_{v_f} = e^{2\pi b p_0}$ is universally Laurent. In fact, given a quiver \mathcal{Q} and a vertex v that has no outgoing arrows to mutable vertices of the quiver, the element X_v is universally Laurent. This fact has been proven in [SS19, Proposition 4.10], following a trick taught to us by Linhui Shen.

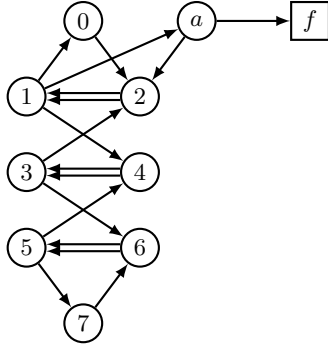

FIGURE 3. Quiver $\widehat{\mathcal{Q}}_4$.

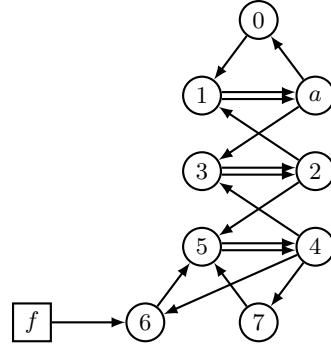

FIGURE 4. Quiver $\widehat{\mathcal{Q}}'_4$.

Let us now consider an expression

$$X'_f := Q_n(x_0)^{-1} X_f Q_n(x_0) = \mu_{2n-2} \dots \mu_2 \mu_1 \mu_a(X_f).$$

Clearly, this expression is universally Laurent as well, since it is mutation equivalent to X_f . On the other hand, we have

$$X'_f = Q_n(x_0)^{-1} e^{2\pi b p_0} Q_n(x_0) = Q_n(x_0)^{-1} Q_n(x_0 - ib) e^{2\pi b p_0} = \sum_{k=0}^n H_k^{(n)} e^{2\pi b(p_0 + k x_0)}.$$

One can see that the quiver $\widehat{\mathcal{Q}}'_n = \mu_{2n-2} \dots \mu_1 \mu_a(\widehat{\mathcal{Q}}_n)$ has labels

$$\begin{aligned} v_{2k-2} &= p_k - p_{k+1} + x_k - x_{k+1}, & v_{2n-2} &= p_n + x_0, \\ v_{2j-1} &= x_{j+1} - x_j, & v_{2n-1} &= p_n + v, \end{aligned}$$

for $1 \leq j \leq n-1$ and $2 \leq k \leq n-1$, together with

$$v_0 = -p_1 - u, \quad v_a = p_1 - p_2 + x_1 - x_2, \quad v_f = p_0.$$

Let us now freeze the vertex v_{2n-2} in $\widehat{\mathcal{Q}}'_n$, and denote the resulting quiver by $\widehat{\mathcal{Q}}_n^*$. Then, the unfrozen part of $\widehat{\mathcal{Q}}_n^*$, including the labels, is identical to that of \mathcal{Q}_n . Since X'_f is universally Laurent in the cluster structure defined by $\widehat{\mathcal{Q}}'_n$, it is also universally Laurent in the cluster structure defined by $\widehat{\mathcal{Q}}_n^*$, and hence by \mathcal{Q}_n . Moreover, since the unfrozen part of $\widehat{\mathcal{Q}}_n^*$ does not involve x_0 or p_0 , each coefficient of expression X'_f written as a polynomial in $e^{2\pi b x_0}$ and $e^{2\pi b p_0}$ is universally Laurent as well. This finishes the proof. \square

4. b -WHITTAKER TRANSFORM

In this section we summarize the main results obtained in [SS18]. Throughout this section we will employ the following vector notations. Boldface letters shall stand for vectors, e.g. $\mathbf{x} = (x_1, \dots, x_n)$. Given such a vector \mathbf{x} , we denote the sum of its coordinates by

$$\underline{\mathbf{x}} = x_1 + \dots + x_n.$$

We also make use of the ‘‘Russian rebus’’ conventions, and denote the vectors obtained by deleting the first and last coordinates in \mathbf{x} by

$$\begin{aligned} \mathbf{x}' &= (x_1, \dots, x_{n-1}), & \mathbf{x}' &= (x_2, \dots, x_n), \\ \mathbf{x}'' &= (x_1, \dots, x_{n-2}), & \mathbf{x}'' &= (x_3, \dots, x_n), \end{aligned}$$

et cetera. We will also make use of the following definition.

Definition 4.1. For $\boldsymbol{\lambda} \in \mathbb{R}^n$, we define the Sklyanin measure on \mathbb{R}^n to be

$$m(\boldsymbol{\lambda})d\boldsymbol{\lambda} = \frac{1}{n!} \prod_{j \neq k}^n \frac{1}{c(\lambda_j - \lambda_k)} d\boldsymbol{\lambda}. \quad (4.1)$$

4.1. The b -Whittaker functions. We define the b -Whittaker functions for \mathfrak{gl}_n by the formula

$$\Psi_{\lambda_1, \dots, \lambda_n}^{(n)}(x_1, \dots, x_n) = R_n(\lambda_n^*) \dots R_2(\lambda_2^*) e^{2\pi i \boldsymbol{\lambda} \cdot \mathbf{x}},$$

where

$$R_n(\lambda^*) = Q_n(\lambda^*) \varphi(p_n + \lambda^*)^{-1} \quad \text{and} \quad \lambda^* = c_b - \lambda.$$

Similarly to the Baxter operator, the operator $R_n(u)$ can be realized via the following mutations sequence in \mathcal{Q}_n :

$$R_n(u)^{-1} = \mu_{2n-3} \dots \mu_1 \mu_0.$$

Note that the b -Whittaker function $\Psi_{\boldsymbol{\lambda}}^{(n)}(\mathbf{x})$ admits a recursive definition:

$$\Psi_{\boldsymbol{\lambda}}^{(n)}(\mathbf{x}) = R_n(\lambda_n^*) e^{2\pi i \lambda_n x_n} \Psi_{\boldsymbol{\lambda}'}^{(n-1)}(\mathbf{x}').$$

Now, formula (1.7) allows us to rewrite the above expression via integral operators:

$$\Psi_{\lambda}^{(n)}(\mathbf{x}) = e^{\pi i c_b \sum_{j=1}^{n-1} (\lambda_n - \lambda_j)} \int K_{n-1}(\mathbf{y}, \mathbf{x}; \lambda_n) \Psi_{\lambda'}^{(n-1)}(\mathbf{y}) d\mathbf{y}.$$

where

$$K_{n-1}(\mathbf{y}, \mathbf{x}; \lambda_n) = \zeta^{1-n} \frac{e^{2\pi i \lambda_n (\underline{\mathbf{x}} - \underline{\mathbf{y}})} \prod_{k=1}^{n-2} \varphi(y_{k+1} - y_k)}{\prod_{k=1}^{n-1} \varphi(y_k - x_k - c_b) \varphi(x_{k+1} - y_k)}.$$

This in turn yields a modular b -analog of Givental's formula for the undeformed \mathfrak{gl}_n Whittaker functions as an integral over triangular arrays, see [Giv97, GKLO06].

It was also shown in [SS18], that the b -Whittaker functions defined above are equal to those defined in [KLS02] via an analogue of a modular b -analog of Mellin-Barnes formula. Namely, if we define the *Mellin-Barnes normalization* of the b -Whittaker function to be

$$\psi_{\lambda}^{(n)}(\mathbf{x}) = e^{\frac{\pi i(1-n)}{2} \sum_{j=1}^n \lambda_j^2} \Psi_{\lambda}^{(n)}(\mathbf{x}), \quad (4.2)$$

then one can write

$$\psi_{\lambda}^{(n)}(\mathbf{x}) = \int L_{n-1}(\boldsymbol{\mu}, \boldsymbol{\lambda}; x_n) \psi_{\boldsymbol{\mu}}^{(n-1)}(\mathbf{x}') m(\boldsymbol{\mu}) d\boldsymbol{\mu}, \quad (4.3)$$

where

$$L_{n-1}(\boldsymbol{\mu}, \boldsymbol{\lambda}; x_n) = \zeta^{1-n} e^{\pi i (2x_n - \underline{\boldsymbol{\mu}})(\boldsymbol{\lambda} - \underline{\boldsymbol{\mu}})} \prod_{j=1}^n \prod_{k=1}^{n-1} c(\lambda_j - \mu_k). \quad (4.4)$$

Note that in formula (4.3), the b -Whittaker function for \mathfrak{gl}_n is expressed as an integral operator in *spectral variables* $\boldsymbol{\lambda}$ applied to the b -Whittaker function for \mathfrak{gl}_{n-1} depending on the first $n-1$ *coordinate variables* x_1, \dots, x_{n-1} . In what follows, it will be instrumental to have a similar formula, but with the b -Whittaker function for \mathfrak{gl}_{n-1} depending on the last $n-1$ *coordinate variables* x_2, \dots, x_n . Using the involution ϑ_n defined in (3.2), the desired formula is obtained from (4.3) by replacing

$$x_j \leftrightarrow -x_{n+1-j}, \quad \lambda_j \leftrightarrow -\lambda_j, \quad \mu_j \leftrightarrow -\mu_j.$$

Namely, we have

$$\psi_{\lambda}^{(n)}(\mathbf{x}) = \int \tilde{L}_{n-1}(\boldsymbol{\mu}, \boldsymbol{\lambda}; x_1) \psi_{\boldsymbol{\mu}}^{(n-1)}(\mathbf{x}') m(\boldsymbol{\mu}) d\boldsymbol{\mu}. \quad (4.5)$$

where

$$\tilde{L}_{n-1}(\boldsymbol{\mu}, \boldsymbol{\lambda}; x_1) = \zeta^{1-n} e^{\pi i (2x_1 - \underline{\boldsymbol{\mu}})(\boldsymbol{\lambda} - \underline{\boldsymbol{\mu}})} \prod_{j=1}^n \prod_{k=1}^{n-1} c(\mu_k - \lambda_j).$$

Finally, the main result of [SS18] is the following theorem.

Theorem 4.2. *The b -Whittaker transform $\mathcal{W}^{(n)}$, defined on the space of rapidly decaying test functions by the formula*

$$\mathcal{W}^{(n)}[f](\boldsymbol{\lambda}) = \int_{\mathbb{R}^n} f(\mathbf{x}) \overline{\Psi_{\lambda}^{(n)}(\mathbf{x})} d\mathbf{x},$$

extends to a unitary equivalence

$$\mathcal{W}^{(n)}: L^2(\mathbb{R}^n) \rightarrow L^2_{\text{sym}}(\mathbb{R}^n, m(\boldsymbol{\lambda})),$$

where the target is the Hilbert space of symmetric functions in $e^{2\pi b\lambda_j}$, $j = 1, \dots, n$, that are square-integrable with respect to the Sklyanin measure $m(\boldsymbol{\lambda})$.

It was also shown in [SS18] that the b -Whittaker functions are eigenfunctions for Baxter operators.

Proposition 4.3. *We have*

$$Q_n(u)\Psi_{\boldsymbol{\lambda}}^{(n)}(\mathbf{x}) = \prod_{j=1}^n \varphi(u + \lambda_j)\Psi_{\boldsymbol{\lambda}}^{(n)}(\mathbf{x}),$$

$$\tilde{Q}_n(v)\Psi_{\boldsymbol{\lambda}}^{(n)}(\mathbf{x}) = \prod_{j=1}^n \varphi(-v - \lambda_j)\Psi_{\boldsymbol{\lambda}}^{(n)}(\mathbf{x}).$$

This result implies that the b -Whittaker functions are also eigenfunctions for quantum Toda Hamiltonians as well as for the Dehn twist operator.

Proposition 4.4. *The b -Whittaker functions are common eigenfunctions of the Toda Hamiltonians: we have*

$$H_k^{(n)}\Psi_{\boldsymbol{\lambda}}^{(n)}(\mathbf{x}) = e_k(\boldsymbol{\lambda})\Psi_{\boldsymbol{\lambda}}^{(n)}(\mathbf{x}),$$

$$\tilde{H}_k^{(n)}\Psi_{\boldsymbol{\lambda}}^{(n)}(\mathbf{x}) = e_k(-\boldsymbol{\lambda})\Psi_{\boldsymbol{\lambda}}^{(n)}(\mathbf{x})$$

where $e_k(\boldsymbol{\lambda})$ is the k -th elementary symmetric function in variables $e^{2\pi b\lambda_j}$.

Proposition 4.5. *The b -Whittaker function $\Psi_{\boldsymbol{\lambda}}^{(n)}(\mathbf{x})$ is an eigenfunction of the Dehn twist operator D_n with eigenvalue given by*

$$\tau_n\Psi_{\boldsymbol{\lambda}}^{(n)}(\mathbf{x}) = e^{-\pi i \sum_{j=1}^n \lambda_j^2}\Psi_{\boldsymbol{\lambda}}^{(n)}(\mathbf{x}).$$

4.2. Intertwining properties of the b -Whittaker transform. Let us summarize the previous two propositions.

Theorem 4.6. *The Whittaker transforms has the following intertwining properties:*

$$\mathcal{W}^{(n)} \circ H_k^{(n)} = e_k(\boldsymbol{\lambda}) \circ \mathcal{W}^{(n)},$$

$$\mathcal{W}^{(n)} \circ \tilde{H}_k^{(n)} = e_k(-\boldsymbol{\lambda}) \circ \mathcal{W}^{(n)},$$

$$\mathcal{W}^{(n)} \circ \tau_n = e^{-\pi i \sum_{j=1}^n \lambda_j^2} \circ \mathcal{W}^{(n)}.$$

We shall now consider a few more operators on the Toda coordinate space, as well as their images under the Whittaker transform. These operators play crucial role in what follows. Let us define

$$C_k^{(n)} = e^{-2\pi b x_n} H_{k-1}^{(n-1)} \quad \text{and} \quad \tilde{C}_k^{(n)} = e^{2\pi b x_1} \tilde{H}_{k-1}^{[2\dots n]},$$

where the operator $H_r^{[2\dots n]}$ is the r -th Hamiltonian of the \mathfrak{gl}_{n-1} -Toda, written in variables $\{x_2, \dots, x_n\}$ rather than $\{x_1, \dots, x_{n-1}\}$. Equivalently, one can write

$$\tilde{C}_k^{(n)} = \vartheta_n \left(C_k^{(n)} \right).$$

For example, we have

$$\begin{aligned} C_2^{(3)} &= e^{-2\pi b x_3} \left(e^{2\pi b p_1} + e^{2\pi b p_2} + e^{2\pi b(p_2 + x_2 - x_1)} \right), \\ \tilde{C}_2^{(3)} &= e^{2\pi b x_1} \left(e^{-2\pi b p_3} + e^{-2\pi b p_2} + e^{-2\pi b(p_2 - x_3 + x_2)} \right). \end{aligned}$$

Set $w_j = e^{2\pi b \lambda_j}$ and define $D_j = e^{ib \frac{\partial}{\partial \lambda_j}}$, so that $D_j w_k = q^{2\delta_{jk}} w_k D_j$ and

$$D_j \cdot f(\boldsymbol{\lambda}) = f(\lambda_1, \dots, \lambda_{j-1}, \lambda_j + ib, \lambda_{j+1}, \dots, \lambda_n).$$

Theorem 4.7. *The following intertwining relations hold:*

$$\begin{aligned} \mathcal{W}^{(n)} \circ C_k^{(n)} &= (-q)^{\frac{n-1}{2}} \sum_{j=1}^n e_{k-1}(\boldsymbol{\lambda} \setminus \{\lambda_j\}) \prod_{r \neq j} (1 - w_r/w_j)^{-1} D_j^{-1} \circ \mathcal{W}^{(n)}, \\ \mathcal{W}^{(n)} \circ \tilde{C}_k^{(n)} &= (-q)^{\frac{n-1}{2}} \sum_{j=1}^n \tilde{e}_{k-1}(\boldsymbol{\lambda} \setminus \{\lambda_j\}) \prod_{r \neq j} (1 - w_j/w_r)^{-1} D_j \circ \mathcal{W}^{(n)} \end{aligned}$$

where $e_k(\boldsymbol{\lambda} \setminus \{\lambda_j\})$ and $\tilde{e}_k(\boldsymbol{\lambda} \setminus \{\lambda_j\})$ are the k -th elementary symmetric functions in variables $w_1, \dots, \hat{w}_j, \dots, w_n$ and their inverses respectively.

Proof. Let us start by calculating the result of application of the shift operator D_r to the kernel (4.4). Using properties of the c -function we obtain

$$\begin{aligned} D_r L_{n-1}(\boldsymbol{\mu}, \boldsymbol{\lambda}; x_n) &= (-i)^{n-1} e^{\pi b(\underline{\mu} - 2x_n)} \prod_{k=1}^{n-1} \left(e^{\pi b(\lambda_r - \mu_k)} - e^{\pi b(\mu_k - \lambda_r)} \right) L_{n-1}(\boldsymbol{\mu}, \boldsymbol{\lambda}; x_n) \\ &= (-i)^{n-1} e^{(n-1)\pi b \lambda_r} e^{-2\pi b x_n} \prod_{k=1}^{n-1} \left(1 - e^{2\pi b(\mu_k - \lambda_r)} \right) L_{n-1}(\boldsymbol{\mu}, \boldsymbol{\lambda}; x_n). \end{aligned} \tag{4.6}$$

Now, we assemble the operators $C_k^{(n)}$ into a generating function

$$C_n(u) = \sum_{k=0}^{n-1} U^{-k} C_{k+1}^{(n)} \quad \text{with} \quad U = -e^{2\pi b u}.$$

Applying $C_n(u)$ to the Mellin-Barnes normalization $\psi_{\boldsymbol{\lambda}}^{(n)}(\mathbf{x})$ of the Whittaker function, and using formula (4.3) we have

$$\begin{aligned} C_n(u) \psi_{\boldsymbol{\lambda}}^{(n)}(\mathbf{x}) &= \sum_{k=0}^{n-1} U^{-k} e^{-2\pi b x_n} H_k^{(n-1)} \psi_{\boldsymbol{\lambda}}^{(n)}(\mathbf{x}) \\ &= \sum_{k=0}^{n-1} U^{-k} e^{-2\pi b x_n} \int L_{n-1}(\boldsymbol{\mu}, \boldsymbol{\lambda}; x_n) H_k^{(n-1)} \psi_{\boldsymbol{\mu}}^{(n-1)}(\mathbf{x}') m(\boldsymbol{\mu}) d\boldsymbol{\mu}. \end{aligned}$$

By Proposition 4.4, we get

$$\begin{aligned} C_n(u)\psi_\lambda^{(n)}(\mathbf{x}) &= e^{-2\pi b x_n} \int L_{n-1}(\boldsymbol{\mu}, \boldsymbol{\lambda}; x_n) \sum_{k=0}^{n-1} U^{-k} e_k(\boldsymbol{\mu}) \psi_{\boldsymbol{\mu}}^{(n-1)}(\mathbf{x}') m(\boldsymbol{\mu}) d\boldsymbol{\mu} \\ &= e^{-2\pi b x_n} \int \prod_{j=1}^{n-1} \left(1 - e^{2\pi b(\mu_j - u)}\right) L_{n-1}(\boldsymbol{\mu}, \boldsymbol{\lambda}; x_n) \psi_{\boldsymbol{\mu}}^{(n-1)}(\mathbf{x}') m(\boldsymbol{\mu}) d\boldsymbol{\mu}. \end{aligned}$$

Substituting $u = \lambda_r$ and comparing the result with (4.6), we see that

$$C_n(\lambda_r)\psi_\lambda^{(n)}(\mathbf{x}) = i^{n-1} e^{(1-n)\pi b \lambda_r} D_r \psi_\lambda^{(n)}(\mathbf{x}).$$

Now by Lagrange interpolation we find

$$C_n(u)\psi_\lambda^{(n)}(\mathbf{x}) = i^{n-1} \sum_{j=1}^n \prod_{k \neq j} \frac{1 - e^{2\pi b(\lambda_k - u)}}{1 - e^{2\pi b(\lambda_k - \lambda_j)}} e^{(1-n)\pi b \lambda_j} D_j \psi_\lambda^{(n)}(\mathbf{x}).$$

Using (4.2) we conclude that

$$C_n(u)\Psi_\lambda^{(n)}(\mathbf{x}) = e^{(n-1)\pi b c_b} \sum_{j=1}^n \prod_{k \neq j} \frac{1 - e^{2\pi b(\lambda_k - u)}}{1 - e^{2\pi b(\lambda_k - \lambda_j)}} D_j \Psi_\lambda^{(n)}(\mathbf{x}).$$

Finally, extracting the coefficient in of U^{-k} we get

$$C_{k+1}^{(n)}\Psi_\lambda^{(n)}(\mathbf{x}) = e^{(n-1)\pi b c_b} \sum_{j=1}^n e_k(\boldsymbol{\lambda} \setminus \{\lambda_j\}) \prod_{r \neq j} (1 - w_r/w_j)^{-1} D_j \Psi_\lambda^{(n)}(\mathbf{x}).$$

This proves the first equality. The proof of the second one is completely analogous, but uses expansion (4.5) instead of (4.3). \square

Let us define operators

$$C_{k,s}^{(n)} = \tau_n^{s-n} \left(e^{2\pi b(\mathbf{p} - x_n)} H_{k-1}^{(n-1)} \right) \quad \text{and} \quad \tilde{C}_{k,s}^{(n)} = \tau_n^{s-n} \left(e^{2\pi b(x_1 - \mathbf{p})} H_{k-1}^{[2 \dots n]} \right),$$

then it is also straightforward to verify that

$$\mathcal{W}^{(n)} C_{k,s}^{(n)} = (-q)^{\frac{3(n-1)}{2}} \sum_{j=1}^n e_{k-1}(\boldsymbol{\lambda} \setminus \{\lambda_j\}) \prod_{r \neq j} (1 - w_j/w_r)^{-1} (q^{-1} w_j)^s D_j^{-1} \circ \mathcal{W}^{(n)}, \quad (4.7)$$

$$\mathcal{W}^{(n)} \tilde{C}_{k,s}^{(n)} = (-q)^{\frac{3(n-1)}{2}} \sum_{j=1}^n \tilde{e}_{k-1}(\boldsymbol{\lambda} \setminus \{\lambda_j\}) \prod_{r \neq j} (1 - w_r/w_j)^{-1} (q w_j)^{-s} D_j \circ \mathcal{W}^{(n)}. \quad (4.8)$$

In order to avoid fractional powers of q and imaginary units in the right-hand side of formulas (4.7) and (4.8), let us introduce the shifted b -Whittaker transform

$$\mathcal{W}_\alpha^{(n)} = \mathcal{W}^{(n)} e^{-2\pi i \alpha \mathbf{x}}.$$

The shifted b -Whittaker transform is a unitary equivalence

$$\mathcal{W}_\alpha^{(n)}: L_2(\mathbb{R}^n, d_\alpha \mathbf{x}) \longrightarrow L_2^{\text{sym}}(\mathbb{R}^n, m(\boldsymbol{\lambda}) d\boldsymbol{\lambda}),$$

with respect to the shifted measure

$$d_\alpha \mathbf{x} = e^{-4\pi i \alpha \mathbf{x}} d\mathbf{x}.$$

For the remainder of the paper we fix

$$\alpha = \frac{1}{2} \frac{1-n}{1+n} c_b.$$

The following result is a direct corollary of formulas (4.7) and (4.8).

Proposition 4.8. *Then the shifted b -Whittaker transform satisfies*

$$\begin{aligned} \mathcal{W}_\alpha^{(n)} C_{1,s}^{(n)} &= (-q)^{n-1} \sum_{j=1}^n \prod_{r \neq j} (1 - w_j/w_r)^{-1} (q^{-1}w_j)^s D_j^{-1} \circ \mathcal{W}_\alpha^{(n)}, \\ \mathcal{W}_\alpha^{(n)} \tilde{C}_{1,s}^{(n)} &= q^{2(n-1)} \sum_{j=1}^n \prod_{r \neq j} (1 - w_r/w_j)^{-1} (qw_j)^{-s} D_j \circ \mathcal{W}_\alpha^{(n)}. \end{aligned}$$

5. BI-FUNDAMENTAL BAXTER OPERATOR

The goal of this section is to construct a certain generalization of the top and bottom Baxter operators, which will be of crucial importance in the sequel. First, let us consider a family of quivers $\mathcal{Q}_{m,n}$ glued from (parts of) quivers \mathcal{Q}_m and \mathcal{Q}_n in the way shown in Figures 5 and 6. For example, erasing the vertex v_7 in the quiver \mathcal{Q}_4 we obtain the quiver $\mathcal{Q}_{4,1}$, whereas erasing the vertex v_0 we obtain the quiver $\mathcal{Q}_{1,4}$. We label the vertices of $\mathcal{Q}_{m,n}$ as follows:

$$v_0 = q_n - p_1$$

and

$$\begin{aligned} v_{2j} &= x_{j+1} - x_j, & v_{2j-1} &= p_j - p_{j+1} + x_j - x_{j+1} & \text{for } j &= 1, \dots, m-1, \\ v_{-2j} &= y_{j+1} - y_j, & v_{-2j+1} &= q_j - q_{j+1} + y_j - y_{j+1} & \text{for } j &= 1, \dots, n-1. \end{aligned}$$

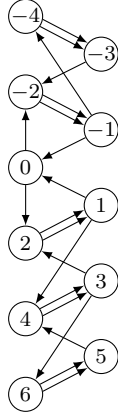

FIGURE 5. Quiver $\mathcal{Q}_{4,3}$

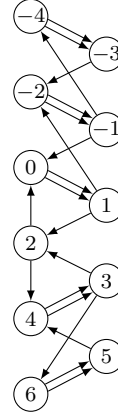

FIGURE 6. Quiver $\mathcal{Q}_{3,4}$

Given the quiver $\mathcal{Q}_{m,n}$, we can use the material presented in section 4 to form commuting family of \mathfrak{gl}_m - and \mathfrak{gl}_n -Toda Hamiltonians acting in variables \mathbf{x} and \mathbf{y}

respectively, together with the corresponding b -Whittaker functions. Our goal now would be to find a sequence of cluster mutations in $\mathcal{Q}_{m,n}$, which defines an operator $Q_{m,n}$ such that

$$Q_{m,n} \Psi_{\lambda}^{(m)}(\mathbf{x}) \Psi_{\eta}^{(n)}(\mathbf{y}) = \prod_{j=1}^m \prod_{k=1}^n \varphi(\lambda_j - \eta_k) \Psi_{\lambda}^{(m)}(\mathbf{x}) \Psi_{\eta}^{(n)}(\mathbf{y}).$$

Note that by Proposition 4.3 we have

$$Q_{m,1} = Q_m(-q_1) = Q_m(-\eta_1) \quad \text{and} \quad Q_{1,n} = \tilde{Q}_n(-p_1) = \tilde{Q}_n(-\lambda_1).$$

We now proceed to the description of the desired sequence of mutations $\mu_{m,n}$. Given the quiver $\mathcal{Q}_{m,n}$ we form a rectangular array of numbers $2 - 2n, \dots, 2m - 2$ as shown in Figure 7. The sequence $\mu_{m,n}$ is then described by reading the array in a specific order, and mutating at the nodes with corresponding numbers. Namely, we read the array left to right, while in each column we first read circled numbers bottom to top, and then the uncircled numbers top to bottom. For example, Figure 7 define the following sequence of mutations in the quiver $\mathcal{Q}_{4,3}$:

$$\begin{aligned} \mu_{4,3} = & \mu_2(\mu_3\mu_1)(\mu_2\mu_0\mu_4)(\mu_5\mu_1\mu_{-1}\mu_3)(\mu_4\mu_0\mu_{-2}\mu_2\mu_6)(\mu_3\mu_{-1}\mu_{-3}\mu_1\mu_5) \\ & (\mu_2\mu_{-2}\mu_{-4}\mu_0\mu_4)(\mu_1\mu_{-3}\mu_{-1}\mu_3)(\mu_0\mu_{-2}\mu_2)(\mu_{-1}\mu_1)\mu_0. \end{aligned}$$

Proof of the following result is a tedious but straightforward combinatorial calculation, which is easiest to carry out using Keller's mutation applet [Kel].

Proposition 5.1. *Under the sequence $\mu_{m,n}$, the quiver $\mathcal{Q}_{m,n}$ becomes $\mathcal{Q}_{n,m}$ with vertices renumbered as in Figure 6.*

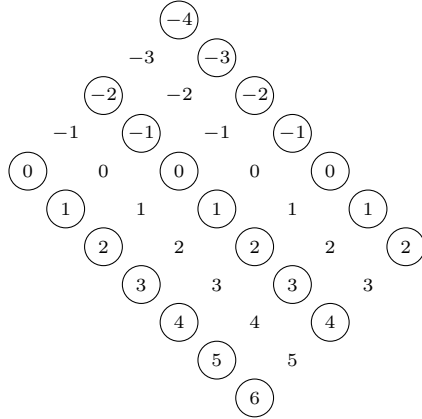

FIGURE 7. Mutation sequence $\mu_{4,3}$

Definition 5.2. The *bifundamental Baxter operator* $Q_{m,n}$ is defined via

$$Q_{m,n}^{-1} = \mu_{m,n}.$$

Remark 5.3. Note, that the definition (5.2) indeed implies

$$Q_{m,1} = Q_m(-q_1) = Q_m(-\eta_1) \quad \text{and} \quad Q_{1,n} = \tilde{Q}_n(-p_1) = \tilde{Q}_n(-\lambda_1).$$

Proposition 5.4. *The quiver $Q_{n,m} = \mu_{m,n}(Q_{m,n})$ has the same set of labels as the quiver $Q_{m,n}$ except for $q_n - p_1$ is replaced by $p_m - q_1$.*

Proof. The proof is a direct computation which only involves quiver mutation rules and formula (2.2). \square

We shall now spell out the bifundamental Baxter operator $Q_{m,n}$ as a product of quantum dilogarithms. Namely, let us set

$$\varkappa_i = p_{i+1} + x_{i+1} - x_i \quad \text{and} \quad \varrho_i = q_{i-1} + y_{i-1} - y_i,$$

and use the following notation

$$\overleftarrow{\prod}_{i=a}^b x_i = x_b x_{b-1} \dots x_a \quad \text{and} \quad \overrightarrow{\prod}_{i=a}^b x_i = x_a x_{a+1} \dots x_b.$$

We then define operators

$$Q_{m,n}^k = Q_{m,n}^{k\bullet} Q_{m,n}^{k\bullet}$$

where for $k < m$

$$Q_{m,n}^{k\bullet} = \overleftarrow{\prod}_{i=k}^{\max(1,k-n+1)} (\varphi(p_i - q_{i-k+n}) \varphi(\varkappa_i - q_{i-k+n})),$$

for $k \geq m$

$$Q_{m,n}^{k\bullet} = \varphi(p_m - q_{m-k+n}) \overleftarrow{\prod}_{i=m-1}^{\max(1,k-n+1)} (\varphi(p_i - q_{i-k+n}) \varphi(\varkappa_i - q_{i-k+n})),$$

and

$$Q_{m,n}^{k\bullet} = \overrightarrow{\prod}_{i=\max(1,k-n+2)}^{\min(m,k)} \varphi(p_i - \varrho_{i-k+n}) \overleftarrow{\prod}_{i=\min(m-1,k)}^{\max(1,k-n+2)} \varphi(\varkappa_i - \varrho_{i-k+n}).$$

The following proposition follows directly from the definition 5.2 and the quantum cluster mutation rules, however one should exercise some perseverance.

Proposition 5.5. *We have*

$$Q_{m,n} = \overrightarrow{\prod}_{k=1}^{m+n-1} Q_{m,n}^k. \quad (5.1)$$

Example 5.6. In this example we consider $m = 4$, $n = 3$. Then, definition 5.2 yields

$$\begin{aligned}
Q_{4,3} = & \varphi(p_1 - q_3) \\
& \varphi(\varkappa_1 - q_3)\varphi(p_1 - \varrho_3) \\
& \varphi(p_2 - q_3)\varphi(p_1 - q_2)\varphi(\varkappa_1 - \varrho_3) \\
& \varphi(\varkappa_2 - q_3)\varphi(\varkappa_1 - q_2)\varphi(p_1 - \varrho_2)\varphi(p_2 - \varrho_3) \\
& \varphi(p_3 - q_3)\varphi(p_2 - q_2)\varphi(p_1 - q_1)\varphi(\varkappa_2 - \varrho_3)\varphi(\varkappa_1 - \varrho_2) \\
& \varphi(\varkappa_3 - q_3)\varphi(\varkappa_2 - q_2)\varphi(\varkappa_1 - q_1)\varphi(p_2 - \varrho_2)\varphi(p_3 - \varrho_3) \\
& \varphi(p_4 - q_3)\varphi(p_3 - q_2)\varphi(p_2 - q_1)\varphi(\varkappa_3 - \varrho_3)\varphi(\varkappa_2 - \varrho_2) \\
& \varphi(\varkappa_3 - q_2)\varphi(\varkappa_2 - q_1)\varphi(p_3 - \varrho_2)\varphi(p_4 - \varrho_3) \\
& \varphi(p_4 - q_2)\varphi(p_3 - q_1)\varphi(\varkappa_3 - \varrho_2) \\
& \varphi(\varkappa_3 - q_1)\varphi(p_4 - \varrho_2) \\
& \varphi(p_4 - q_1).
\end{aligned}$$

By reshuffling quantum dilogarithms with commuting arguments we can rewrite the operator $Q_{4,3}$ as follows.

$$\begin{aligned}
Q_{4,3} = & \varphi(p_1 - q_3)\varphi(\varkappa_1 - q_3) \\
& \varphi(p_1 - \varrho_3)\varphi(\varkappa_1 - \varrho_3) \\
& \varphi(p_2 - q_3)\varphi(\varkappa_2 - q_3)\varphi(p_1 - q_2)\varphi(\varkappa_1 - q_2) \\
& \varphi(p_1 - \varrho_2)\varphi(p_2 - \varrho_3)\varphi(\varkappa_2 - \varrho_3)\varphi(\varkappa_1 - \varrho_2) \\
& \varphi(p_3 - q_3)\varphi(\varkappa_3 - q_3)\varphi(p_2 - q_2)\varphi(\varkappa_2 - q_2)\varphi(p_1 - q_1)\varphi(\varkappa_1 - q_1) \\
& \varphi(p_2 - \varrho_2)\varphi(p_3 - \varrho_3)\varphi(\varkappa_3 - \varrho_3)\varphi(\varkappa_2 - \varrho_2) \\
& \varphi(p_4 - q_3)\varphi(p_3 - q_2)\varphi(\varkappa_3 - q_2)\varphi(p_2 - q_1)\varphi(\varkappa_2 - q_1) \\
& \varphi(p_3 - \varrho_2)\varphi(p_4 - \varrho_3)\varphi(\varkappa_3 - \varrho_2) \\
& \varphi(p_4 - q_2)\varphi(p_3 - q_1)\varphi(\varkappa_3 - q_1) \\
& \varphi(p_4 - \varrho_2) \\
& \varphi(p_4 - q_1).
\end{aligned}$$

In the latter formula, the $(2k - 1)$ -st line is equal to the operator $Q_{4,3}^{k\bullet}$, while the $2k$ -th line is equal to the operator $Q_{4,3}^{k\circ}$, as k runs from 1 to 6. In particular, we have $Q_{4,3}^{6\bullet} = \varphi(p_4 - q_1)$ and $Q_{4,3}^{6\circ} = 1$.

Theorem 5.7. *The following equation holds for the bifundamental Baxter operator:*

$$Q_{m,n}\Psi_{\lambda}^{(m)}(\mathbf{x})\Psi_{\eta}^{(n)}(\mathbf{y}) = \prod_{j=1}^m \prod_{k=1}^n \varphi(\lambda_j - \eta_k)\Psi_{\lambda}^{(m)}(\mathbf{x})\Psi_{\eta}^{(n)}(\mathbf{y}).$$

Proof. For $m = 1$ the statement of the theorem follows from Proposition 4.3. We shall prove the general case by induction on m . Assume that the statement holds for $m - 1$,

then we have the following equality:

$$R_m(\lambda_m^*)Q_{m-1,n}\tilde{Q}_n(-p_m)\Psi_\lambda^{(m-1)}(\mathbf{x})\Psi_\eta^{(n)}(\mathbf{y}) = \prod_{j=1}^{m-1} \prod_{k=1}^n \varphi(\lambda_j - \eta_k)\Psi_\lambda^{(m-1)}(\mathbf{x})\Psi_\eta^{(n)}(\mathbf{y})$$

Using Proposition (1.5), it is straightforward to show that

$$Q_{m-1,n}\tilde{Q}_n(-p_m)\Psi_\lambda^{(m-1)}(\mathbf{x})\Psi_\eta^{(n)}(\mathbf{y}) = Q_{m,n}^*\Psi_\lambda^{(m-1)}(\mathbf{x})\Psi_\eta^{(n)}(\mathbf{y}),$$

where the operator $Q_{m,n}^*$ is obtained from $Q_{m,n}$ by replacing

$$\begin{aligned} \varphi(\varkappa_m - q_k) &\longmapsto \varphi(\varkappa_m - q_k)\varphi(p_m + \varkappa_m - q_k + \lambda_m^*) && \text{for } 1 \leq k \leq n, \\ \varphi(\varkappa_m - \varrho_j) &\longmapsto \varphi(\varkappa_m - \varrho_j)\varphi(p_m + \varkappa_m - \varrho_j + \lambda_m^*) && \text{for } 2 \leq j \leq n \end{aligned}$$

in the formula (5.1). Now, the desired result follows from the operator identity

$$R_m(\lambda_m^*)Q_{(m,n)}^* = Q_{m,n}R_m(\lambda_m^*).$$

The latter is a direct but tedious calculation, which only involves applying the pentagon identity over and over again, commuting factors of $Q_{m,n}^*$ all the way to the left past $R_m(\lambda_m^*)$. \square

Since the shifted b -Whittaker transform $\widetilde{\mathcal{W}}^{(n)} \otimes \widetilde{\mathcal{W}}^{(m)}$ commutes with the product $e^{-2\pi i c_b \mathbf{x}} e^{-2\pi i c_b \mathbf{y}}$, we obtain the following corollary.

Corollary 5.8. *The bi-fundamental Baxter operator satisfies the following intertwining relation under the shifted b -Whittaker transform:*

$$\left(\widetilde{\mathcal{W}}^{(n)} \otimes \widetilde{\mathcal{W}}^{(m)}\right) \circ Q_{n,m} = \prod_{j=1}^n \prod_{k=1}^m \varphi(\lambda_j - \mu_k) \circ \left(\widetilde{\mathcal{W}}^{(n)} \otimes \widetilde{\mathcal{W}}^{(m)}\right).$$

6. RECOLLECTIONS ON COULOMB BRANCHES.

6.1. Basic notations. In this section we recall the construction of the quantized K -theoretic Coulomb branch \mathcal{A}_q of a $3d \mathcal{N} = 4$ quiver gauge theory due to Braverman, Finkelberg and Nakajima, see [Nak15, BFN16]. Such a theory is determined by a quiver Γ with the nodes Γ_0 and arrows Γ_1 , and a pair of Γ_0 -graded finite dimensional vector spaces

$$V = \bigoplus_{i \in \Gamma_0} V_i \quad \text{and} \quad W = \bigoplus_{i \in \Gamma_0} W_i.$$

We also set $d_W = \dim(W)$, and write $d_k = \dim(V_k)$ for $k \in \Gamma_0$. The gauge group

$$GL(V) = \prod_{i \in \Gamma_0} GL(V_i)$$

is represented on the space

$$N = \bigoplus_{i \rightarrow j} \text{Hom}_{\mathbb{C}}(V_i, V_j) \oplus \bigoplus_{i \in \Gamma_0} \text{Hom}(W_i, V_i),$$

In what follows, we will think of vector spaces V_i and W_i as corresponding to the *gauge* and *framing* nodes of the quiver Γ . In other words, we might say that we extend Γ by adding an additional framing node i' and an arrow $i \rightarrow i'$ for every gauge node $i \in \Gamma_0$.

Define the maximal torus

$$T_W \subset \prod_{i \in \Gamma_0} GL(W_i)$$

and denote the equivariant parameters corresponding to a choice of the basis in W by z_j , $1 \leq j \leq d_W$, so that

$$K_{T_W}(\text{pt}) = \mathbb{C}[z_1^{\pm 1}, \dots, z_{d_W}^{\pm 1}]$$

Let us also define an additional torus

$$T_\Gamma = H^1(\Gamma, \mathbb{C}^*) \simeq (\mathbb{C}^*)^g,$$

and choose a collection of 1-cochains (c_1, \dots, c_g)

$$c_i: \mathbb{Z}^{\Gamma_1} \longrightarrow \mathbb{Z}$$

on Γ whose cohomology classes generate $H^1(\Gamma, \mathbb{Z})$. Without loss of generality we may assume that $c_i(a) = 0$ for any edge a joining a gauge and a framing node. We then define the action of T_Γ on N by declaring that for an arrow $a: j \rightarrow k$, the class c_i acts on the vector space $\text{Hom}(V_j, V_k)$ with weight $c_i(a)$. We denote the equivariant parameter corresponding to the class c_i by u_i , so that

$$K_{T_\Gamma}(\text{pt}) = \mathbb{C}[u_1^{\pm 1}, \dots, u_g^{\pm 1}],$$

and write

$$u(a) = \prod_{i=1}^g u_i^{c_i(a)}$$

for any edge $a: j \rightarrow k$. Finally, we define the *full torus of flavor symmetry* by

$$T_F = T_W \times T_\Gamma.$$

As in [FT17], we introduce the two-fold cover $\tilde{\mathbb{C}}^* \rightarrow \mathbb{C}^*$, and consider the extended Coulomb branch algebra

$$\mathcal{A}_q := K^{(GL(V) \times T_F) \mathcal{O} \times \tilde{\mathbb{C}}^*}(\mathcal{R}_{GL(V), N}),$$

where $\mathcal{R}_{GL(V), N}$ is the *variety of triples* introduced in [BFN16]. By construction, \mathcal{A}_q is an algebra over $K_{GL(V) \times T_F \times \tilde{\mathbb{C}}^*}(\text{pt})$.

6.2. Dressed minuscule monopole operators. As in [BFN16], let $w_{i,r}^*$ be the cocharacter of $\mathfrak{gl}(V)$ which is equal to $(0, \dots, 0, 1, 0, \dots, 0)$ on $\mathfrak{gl}(V_i)$ and zero elsewhere; here the 1 occurs in the r -th entry of the d_i -tuple. We denote the corresponding coordinates on T_V and T_V^\vee by $w_{i,r}$ and $D_{i,r}$, where $i \in \Gamma_0$ and $1 \leq r \leq d_i$. Set $\varpi_{i,n}$ to be the n -th fundamental coweight of $\mathfrak{gl}(V_i)$, so that

$$\varpi_{i,n} = w_{i,1}^* + \dots + w_{i,n}^*.$$

Then the corresponding $GL(V)(\mathcal{O})$ -orbit $\text{Gr}_{GL(V)}^{\varpi_{i,n}}$ in the $GL(V)$ affine Grassmannian is closed and isomorphic to the finite dimensional Grassmannian $\text{Gr}(V_i, n)$ parameterizing n -dimensional quotients of V_i . We denote by $R_{\varpi_{i,n}}$ the pre-image of this orbit under the canonical projection from the variety of triples $\mathcal{R}_{GL(V), N}$ to the affine Grassmannian $\text{Gr}_{GL(V)}$, and write \mathcal{Q}_i for the pullback to $R_{\varpi_{i,n}}$ of the tautological bundle on $\text{Gr}(V_i, n)$. For any symmetric Laurent polynomial f in n variables, we can consider the class $f(\mathcal{Q}_i)$.

Its definition is extended from the case of the elementary symmetric functions, in which we set $e_p(\mathcal{Q}_i) = \bigwedge^p(\mathcal{Q}_i)$.

In a similar fashion, for $\varpi_{i,n}^* = -w_0(\varpi_{i,n})$ the corresponding orbit in the affine Grassmannian is isomorphic to the Grassmannian of n -dimensional subspaces of V_i ; we denote its preimage in $\mathcal{R}_{GL(V),N}$ by $\mathcal{R}_{\varpi_{i,n}^*}$, and write \mathcal{S}_i for the pullback to $\mathcal{R}_{\varpi_{i,n}^*}$ of the tautological bundle.

Classes of sheaves of the form $f(\mathcal{Q}_i) \otimes \mathcal{O}_{\mathcal{R}_{\varpi_{i,n}^*}}$ and $f(\mathcal{S}_i) \otimes \mathcal{O}_{\mathcal{R}_{\varpi_{i,n}^*}}$ are called *dressed minuscule monopole operators*. It was shown in [Wee19], that dressed minuscule monopole operators labelled by $\varpi_{i,1}$ and $\varpi_{i,1}^*$ generate, as i runs over Γ_0 , the homological Coulomb branch algebra \mathcal{A}_q as an algebra over $H_{GL(V) \times T_F \times \tilde{\mathcal{C}}^*}^\bullet(\text{pt})$. Similar result is certainly expected to hold in the K -theoretic case, however at the moment, the only analogous K -theoretic statement found in the literature is due to Finkelberg and Tsymbaliuk, see [FT19], and claims that for quivers of type A the K -theoretic Coulomb branch algebra \mathcal{A}_q as an algebra over $K_{GL(V) \times T_F \times \tilde{\mathcal{C}}^*}^\bullet(\text{pt})$. The latter ring coincides with the ring of Laurent polynomials in the variables $\{w_{i,r}\}$ symmetric in the groups $w_{i,\bullet}$, and with coefficients in the ring of Laurent polynomials in the variables u_i, z_i .

Now consider the Coulomb branch for the abelian theory $K^{(T_V \times T_F) \circ \times \tilde{\mathcal{C}}^*}(\mathcal{R}_{T_V,0})$, which is an algebra isomorphic to the ring of q -difference operators

$$\mathcal{D}_q(\Gamma) = \mathbb{C}[q^{\pm 1}, u_1^{\pm 1}, \dots, u_g^{\pm 1}, z_1^{\pm 1}, \dots, z_N^{\pm 1}] \otimes \mathbb{C} \langle D_{i,r}, w_{i,r} \rangle.$$

with relations

$$D_{i,r} w_{j,s} = q^{2\delta_{i,j}\delta_{r,s}} w_{j,s} D_{i,r}$$

This algebra has a natural functional representation on the ring $K_{T_V \times T_F \times \tilde{\mathcal{C}}^*}(\text{pt})$, in which

$$D_{i,r} \cdot f = f(w_{i,r} \mapsto qw_{i,r}).$$

As explained in [FT17], there is an algebra embedding

$$\mathbf{z}^*(\iota_*)^{-1} : \mathcal{A}_q \hookrightarrow \mathcal{D}_q(\Gamma)^{\text{rat}}$$

of the Coulomb branch algebra \mathcal{A}_q into the localization $\mathcal{D}_q(\Gamma)^{\text{rat}}$ of $\mathcal{D}_q(\Gamma)$ at the Ore set $\{w_{i,r}w_{i,s}^{-1}\}$ where $i \in \Gamma_0$ and $1 \leq r, s \leq d_i$. Formulas for images of all dressed minuscule monopole operators are provided in [FT17], however in the present text we are only concerned with quivers Γ without loops, and operators

$$E_{i,f} = \mathbf{z}^*(\iota_*)^{-1} \left(f(\mathcal{Q}_i) \otimes \mathcal{O}_{\mathcal{R}_{\varpi_{i,1}}} \right) \quad \text{and} \quad F_{i,f} = \mathbf{z}^*(\iota_*)^{-1} \left(f(\mathcal{S}_i) \otimes \mathcal{O}_{\mathcal{R}_{\varpi_{i,1}^*}} \right).$$

The operators $E_{i,f}$ and $F_{i,f}$ are said to be *dressed* by the function f . Since in the above formula, f is a symmetric function of a single variable, we have $f(x) = x^m$, and write $E_{i;x^m}$ and $F_{i;x^m}$. Explicitly, we have

$$E_{i;x^m} = \sum_{r=1}^{d_i} w_{i,r}^m \mathcal{W}_{i \rightarrow j} \prod_{s \neq r} \left(1 - w_{i,s} w_{i,r}^{-1} \right)^{-1} D_{i,r}, \quad (6.1)$$

$$F_{i;x^m} = \sum_{r=1}^{d_i} q^{-2m} w_{i,r}^m \tilde{\mathcal{W}}_{j \rightarrow i} \prod_t \left(1 - qz_t w_{i,r}^{-1} \right) \prod_{s \neq r} \left(1 - w_{i,r} w_{i,s}^{-1} \right)^{-1} D_{i,r}^{-1}. \quad (6.2)$$

where

$$\mathcal{W}_{i \rightarrow j} = \prod_{a: i \rightarrow j} \prod_{s=1}^{d_j} \left(1 - qu(a)w_{i,r}w_{j,s}^{-1}\right),$$

$$\tilde{\mathcal{W}}_{j \rightarrow i} = \prod_{a: j \rightarrow i} \prod_{s=1}^{d_j} \left(1 - qu(a)w_{j,s}w_{i,r}^{-1}\right).$$

In the formula (6.2), the product over t is taken over all variables from flavour nodes attached to the gauge node i by an arrow.

Let us now choose a spanning tree T for Γ , and a 2-coloring of T . Consider the unique algebra automorphism σ of $\mathcal{D}_q(\Gamma)$ such that

- $\sigma(w_{i,r}) = -w_{i,r}$ for all black nodes $i \in \Gamma_0$;
- $\sigma(w_{i,r}) = w_{i,r}$ for all white nodes $i \in \Gamma_1$;
- $\sigma(D_{i,r}) = 1$ for all nodes $i \in \Gamma_0$;
- $\sigma(z_r) = -z_r$ for all z -variables attached to black vertices;
- $\sigma(z_r) = z_r$ for all z -variables attached to white vertices;
- $\sigma(u(a)) = -u(a)$ for all edges $a \in \Gamma_1 \setminus T_1$ between vertices of the same color;
- $\sigma(u(a)) = u(a)$ for all edges $a \in \Gamma_1 \setminus T_1$ between vertices of different color.

Then we have

$$\sigma(E_{i;x^m}) = \sum_{r=1}^{d_i} w_{i,r}^m \sigma(\mathcal{W}_{i \rightarrow j}) \prod_{s \neq r} \left(1 - w_{i,s}w_{i,r}^{-1}\right)^{-1} D_{i,r}, \quad (6.3)$$

$$\sigma(F_{i;x^m}) = \sum_{r=1}^{d_i} q^{-2m} w_{i,r}^m \sigma(\tilde{\mathcal{W}}_{j \rightarrow i}) \prod_t \left(1 + qz_t w_{i,r}^{-1}\right) \prod_{s \neq r} \left(1 - w_{i,r}w_{i,s}^{-1}\right)^{-1} D_{i,r}^{-1}, \quad (6.4)$$

where

$$\sigma(\mathcal{W}_{i \rightarrow j}) = \prod_{a: i \rightarrow j} \prod_{s=1}^{d_j} \left(1 + qu(a)w_{i,r}w_{j,s}^{-1}\right),$$

$$\sigma(\tilde{\mathcal{W}}_{j \rightarrow i}) = \prod_{a: j \rightarrow i} \prod_{s=1}^{d_j} \left(1 + qu(a)w_{j,s}w_{i,r}^{-1}\right).$$

7. CLUSTER ALGEBRAS ASSOCIATED TO COULOMB BRANCHES.

7.1. From gauge theory to cluster quivers. Consider the quantized K -theoretic Coulomb branch algebra \mathcal{A}_q of a $3d \mathcal{N} = 4$ SUSY quiver gauge theory corresponding to a connected quiver Γ . Let Γ^\dagger be the quiver Γ with the following extra data:

- a choice of orientation on each edge of Γ ;
- a choice of a *marked* gauge node of Γ .

Then, for each quiver Γ^\dagger we shall define a quiver \mathcal{Q}^\dagger , and an embedding

$$\iota^\dagger: \mathcal{A}_q \hookrightarrow \mathbb{L}(\mathcal{X}_{\mathcal{Q}^\dagger})$$

of the quantized Coulomb branch into the universally Laurent algebra of the corresponding quantum cluster algebra. We will also show that the algebra $\mathbb{L}(\mathcal{X}_{\mathcal{Q}^\dagger})$ in fact does not depend on the choices we have made, that is $\mathcal{X}_{\mathcal{Q}^\dagger} = \mathcal{X}_{\mathcal{Q}}$, and thus, we construct embeddings

$$\iota^\dagger: \mathcal{A}_q \hookrightarrow \mathbb{L}(\mathcal{X}_{\mathcal{Q}}),$$

where the extra data \mathcal{Q}^\dagger only labels a choice of generators of a particular cluster chart.

We shall describe the adjacency matrix of the quiver \mathcal{Q}^\dagger by specifying the image of each of its vertices under a label homomorphism in the sense of Section 2.2. Namely, for every gauge node $i \in \Gamma'_0$ of dimension d_i in the quiver Γ we have

- for $1 \leq j < d_i$, there are mutable vertices $y_{2j-1}^{(i)}, y_{2j}^{(i)}$ of \mathcal{Q}^\dagger with labels

$$y_{2j}^{(i)} \mapsto x_{i,j+1} - x_{i,j}, \quad y_{2j-1}^{(i)} \mapsto p_{i,j} - p_{i,j+1} + x_{i,j} - x_{i,j+1};$$

- there is a frozen vertex $y_0^{(i)}$ with label

$$y_0^{(i)} \mapsto x_{i,1} - \underline{p}_{i,\bullet},$$

where we set $\underline{p}_{i,\bullet} = \sum_{k=1}^{d_i} p_{i,k}$;

- if i coincides with the marked gauge node k in Γ^\dagger , there is an additional frozen vertex y_{base} in \mathcal{Q}^\dagger with label

$$y_{\text{base}} \mapsto p_{k,d_k};$$

- for each arrow $a: i \rightarrow j$ in Γ^\dagger , there is a mutable vertex $y^{(a)}$ with label

$$y^{(a)} \mapsto p_{j,d_j} - p_{i,1};$$

- for each flavor node k of dimension d_k and an arrow $k \rightarrow i$ we add mutable vertices $y_i^{W_k}$ with labels

$$y_i^{W_k} \mapsto p_{i,d_i} - z_{k,s}$$

where $1 \leq s \leq d_k$.

The adjacency matrix ϵ^\dagger of the quiver \mathcal{Q}^\dagger is then determined by the labels of its vertices via the commutation relations in the Heisenberg algebra. Namely, if v_1, v_2 are two vertices of \mathcal{Q}^\dagger with labels α_1, α_2 respectively, we declare

$$\epsilon_{v_1, v_2}^\dagger = 2\pi i[\alpha_1, \alpha_2].$$

Remark 7.1. From the description above, we see that the total number of vertices in the cluster algebra quiver \mathcal{Q}^\dagger corresponding to the quiver gauge theory for Γ is given by

$$|\mathcal{Q}^\dagger| = 2 \dim(V) + \dim(W) + 1 - \chi(\Gamma). \quad (7.1)$$

In particular, in the case that the underlying graph of Γ is a tree and additionally we are in the unframed case $W = 0$, then the exchange matrix for \mathcal{Q}^\dagger is non-degenerate.

Remark 7.2. Suppose that m, n is a pair of nodes in Γ with an arrow $i \rightarrow j$. Then the application of the bifundamental Baxter operator Q_{d_i, d_j} to the corresponding subquiver in \mathcal{Q}^\dagger produces a quiver with an almost identical set of labels, except for one has

$p_{i,d_i} - p_{j,1}$ instead of $p_{j,d_j} - p_{i,1}$, and the label of the frozen vertex $y_0^{(i)}$ is replaced as follows:

$$x_{i,1} - \underline{p}_{i,\bullet} \longmapsto x_{i,1} + \underline{p}_{j,\bullet} - \underline{p}_{i,\bullet} - d_j p_{i,1}.$$

Hence, two gauge theory quivers Γ, Γ' that differ only by a change of orientation define the same cluster algebra.

7.2. Center of the Heisenberg algebra $\mathcal{H}_{\mathcal{Q}^\dagger}$. Denote by $\Gamma_0^{\text{fr}} \subset \Gamma_0$ the set of framing vertices of the gauge theory quiver Γ , and write γ_0 for the chosen basepoint vertex $\gamma_0 \in \Gamma$. Let us denote by $\tilde{\Gamma}$ the quiver obtained from Γ by replacing each k -dimensional framing node connected to gauge vertex i by a collection of k nodes, each connected to gauge vertex i by a single arrow, and then gluing all such newly created nodes to the basepoint γ_0 .

Lemma 7.3. *The kernel of the exchange matrix ϵ^\dagger is naturally isomorphic to the fundamental group $\pi_1(\tilde{\Gamma}, \gamma_0)$ of the underlying graph $\tilde{\Gamma}$.*

Proof. Suppose that p is a path in Γ which meets the sequence of vertices

$$(\gamma_0, \gamma_1, \dots, \gamma_m, \gamma_{m+1})$$

in the order indicated, via a sequence of edges $(e_{01}, e_{12}, \dots, e_{m,m+1})$, and the p becomes a loop in $\tilde{\Gamma}$, that is in $\gamma_{m+1} = \gamma_0$. Since $\tilde{\Gamma}$ is a quiver, the edges $e_{i,i+1}$ carry a specified orientation, which may or may not agree with the one along which they are traversed by the path. If the two orientations agree we set $\epsilon(e_{i,i+1}) = 1$, and set $\epsilon(e_{i,i+1}) = -1$ otherwise. We then define a weight with values in the Heisenberg algebra $\mathcal{H} = \langle x_{j,k}, p_{j,k}, z_t \rangle$ on the edges $e_{i,i+1}$ by the rule

$$\text{wt}(e_{i,i+1}) = \epsilon(e_{i,i+1}) y^{(e_{i,i+1})}.$$

We also assign weights to each vertex γ_k with $k \neq 0$ in the path, as follows:

$$\text{wt}(\gamma_k) = \begin{cases} \epsilon(e_{k,k+1}) \sum_{r=1}^{2d_{\gamma_k}} y_r^{(\gamma_k)} & \text{if } \epsilon(e_{k-1,k})\epsilon(e_{k,k+1}) = 1, \\ 0 & \text{otherwise.} \end{cases}$$

Finally, the weights of γ_0 and γ_{m+1} are defined by

$$\text{wt}(\gamma_0) = \begin{cases} y_{\text{base}} + \sum_{r=1}^{2d_{\gamma_0}} y_r^{(\gamma_0)} & \text{if } \epsilon(e_{0,1}) = 1 \\ y_{\text{base}} & \text{if } \epsilon(e_{0,1}) = -1, \end{cases}$$

and

$$\text{wt}(\gamma_{m+1}) = \begin{cases} -y_{\text{base}} & \text{if } \epsilon(e_{m,m+1}) = 1 \\ -y_{\text{base}} - \sum_{r=1}^{2d_{\gamma_0}} y_r^{(\gamma_0)} & \text{if } \epsilon(e_{m,m+1}) = -1. \end{cases}$$

We then associate to the path p the element

$$\alpha(p) = \sum_{k=0}^{m+1} \text{wt}(\gamma_k) + \sum_{k=0}^m \text{wt}(e_{k,k+1}).$$

This assignment is easily seen to be homotopy invariant. Observing that the label homomorphism gives

$$\sum_{r=1}^{2d_{\gamma_k}} y_r^{(\gamma_k)} \mapsto p_1^{(\gamma_k)} - p_{d_{\gamma_k}}^{(\gamma_k)},$$

we see that any closed loop in $\tilde{\Gamma}$ determines a central element $\alpha(p) \in \mathcal{H}$, and that the only loops sent to the zero element are null-homotopic. Thus we obtain

$$b_1(\tilde{\Gamma}) = \dim W + 1 - \chi(\Gamma)$$

linearly independent elements of $\ker(\varepsilon^\dagger)$. On the other hand, it is clear that the rank of the matrix ε^\dagger is at least $2 \dim V$, since we can obtain labels $p_{j,k}, x_{j,k}$ for all j and k as appropriate linear combinations of vertices, and thus the result follows from the dimension count (7.1). \square

8. EMBEDDING THE COULOMB BRANCH ALGEBRA INTO THE CLUSTER ALGEBRA

Recall that the Coulomb branch algebra \mathcal{A}_q is embedded as a subalgebra of the ring of rational q -difference operators $\mathcal{D}_q^{\text{rat}}(\Gamma)$ on the ring of $\prod_{i \in \Gamma_0} \text{Weyl}(GL(V_i))$ -symmetric functions in the variables $\{w_{i,r}\}$. Equally, the label homomorphism embeds the quantum cluster algebra $\mathbb{L}(\mathcal{X}_{\mathcal{Q}^\dagger})$ as a subalgebra in the ring $\mathcal{D}_q(\mathcal{Q}^\dagger)^{\text{pol}}$ of Laurent polynomial q -difference operators in the variables $\{x_{i,r}\}$.

We now consider the unitary transformation $\mathcal{W}_\alpha^\Gamma$ obtained by applying for each node $i \in \Gamma_0$ the shifted GL_{d_i} -Whittaker transform $\mathcal{W}_\alpha^{(d_i)}$, i.e.

$$\mathcal{W}_\alpha^\Gamma = \bigotimes_{i \in \Gamma_0} \mathcal{W}_\alpha^{(d_i)}.$$

Lemma 8.1. *The subalgebra $K_{\widetilde{GL(V)} \times T_F \times \tilde{\mathcal{C}}^*}(\text{pt})$ is contained in the universally Laurent algebra $\mathbb{L}(\mathcal{X}_{\mathcal{Q}^\dagger})$.*

Proof. The subalgebra $K_{\widetilde{GL(V)}}(\text{pt})$ is generated by the elementary symmetric functions $e_k(w_{j,\bullet})$ for $j \in \Gamma_0$ and $1 \leq k \leq d_j$. Under $\mathcal{W}_\alpha^\Gamma$ these operators are intertwined with the Toda Hamiltonians $H_k^{(d_j)}$ in the j -th variable group, and the latter elements are universally Laurent by the same argument used to prove Proposition 3.4. Moreover, the generators $z_k^{\pm 1}, u_k^{\pm 1}$ are universally Laurent as well, since central elements remain unchanged under conjugation by any sequence of quantum dilogarithms. \square

Proposition 8.2. *Suppose that a node $i \in \Gamma_0$ is a sink, that is there are no arrows $a: i \rightarrow j$. Then the corresponding monopole operator $E_{i;x^m}$ satisfies*

$$q^{2(d_i-1)+m} \sigma(E_{i;x^m}) \circ \mathcal{W}_\alpha^\Gamma = \mathcal{W}_\alpha^\Gamma \circ \tau_i^{-d_i-m} \left(Y_0^{(i)} \right), \quad (8.1)$$

where $Y_0^{(i)}$ is the frozen cluster \mathcal{X} -variable with label $y_0^{(i)} = x_{i,1} - \underline{\mathbf{p}}_{i,\bullet}$, attached to the subquiver of \mathcal{Q}^\dagger corresponding to node $i \in \Gamma_0$.

Similarly, if there are no arrows $a: j \rightarrow i$ from a gauge node j to the gauge node i , the corresponding monopole operator $F_{i;x^m}$ satisfies

$$(-1)^{d_i-1} q^{m+d_i-1} \sigma(F_{i,m}) \mathcal{W}_\alpha^\Gamma = \mathcal{W}_\alpha^\Gamma \circ \tau_i^{m-d_i} \circ \prod_{t=1}^{\dim W_i} Q_i(z_t) \left(\tilde{Y}_0^{(i)} \right)$$

where $\tilde{Y}_0^{(i)}$ is the cluster monomial

$$\tilde{Y}_0^{(i)} := Y \left(-e_0^{(i)} - e_2^{(i)} - \cdots - e_{2d_i-2}^{(i)} \right) \mapsto \exp \left(2\pi b \left(\underline{p}_{i,\bullet} - x_{i,n} \right) \right)$$

and $Q_i(z_{i,t})$ is the Baxter operator with the equivariant parameter $z_{i,t}$ for the torus T_{W_j} .

Proof. For operators $E_{i;x^m}$, the proof is immediate from Proposition 4.8 and the description of the labels of the quiver \mathcal{Q}^\dagger . Assume now that $W_i \neq 0$, hence there exist arrows $i' \rightarrow i$ having the framing node i' as their source. Applying Baxter operators with equivariant parameters $z_{i,t}$ as $1 \leq t \leq \dim(W_i)$ we arrive at a case that the vertex i is a source, and does not have incoming arrows from either gauge or framing nodes. The rest of the proof follows from Proposition 4.8. \square

Corollary 8.3. *The images under the inverse b -Whittaker transform of all monopole operators $E_{i;x^m}$ and $F_{i;x^m}$ are contained in the universally Laurent algebra $\mathbb{L}(\mathcal{X}_{\mathcal{Q}^\dagger})$.*

Proof. It is evident from the description of \mathcal{Q}^\dagger that the vertex corresponding to $Y_0^{(j)}$ has no outgoing arrows to mutable vertices of the quiver. Therefore, it is universally Laurent by the same reasoning as in the proof of Proposition 3.4. This proves that $E_{i;x^m} \in \mathbb{L}(\mathcal{X}_{\mathcal{Q}^\dagger})$ for all i and m . In the case of the operators $F_{i;x^m}$, the monomial $\tilde{Y}_0^{(i)}$ coincides with the image of $A_{2d_i-1}^{(i)} \times m_{\text{frozen}}$ under the extension of the ensemble map to principal coefficients³. So once again, the quantum Laurent phenomenon implies that $F_{i;x^m} \in \mathbb{L}(\mathcal{X}_{\mathcal{Q}^\dagger})$. \square

Theorem 8.4. *Let \mathcal{A}_q be the quantized K -theoretic Coulomb branch of a 3d $\mathcal{N} = 4$ quiver gauge theory determined by a quiver Γ , and $\mathcal{A}'_q \subseteq \mathcal{A}_q$ be the subalgebra generated by $K_{\widetilde{GL}(V) \times T_F \times \tilde{C}^*}(\text{pt})$ and the dressed monopole operators $E_{i;x^m}$ and $F_{i;x^m}$. Furthermore, let \mathcal{Q}^\dagger be the cluster algebra quiver associated any choice of base vertex in Γ . Then \mathcal{A}'_q is a subalgebra in the corresponding universally Laurent algebra $\mathbb{L}(\mathcal{X}_{\mathcal{Q}^\dagger})$.*

Proof. We prove the Theorem by reduction to the case treated in Proposition 8.2 with the help of the mutation sequences $Q_{m,n}$ corresponding to the bifundamental Baxter operators. Indeed, in view of the functional equation (1.2) for the quantum dilogarithm and the intertwining property of the bifundamental Baxter operators from Theorem 5.7, we observe that given an arrow $a: i \rightarrow j$ in Γ_1 , the mutation sequence Q_{d_i,d_j} reverses the orientation of a , replacing it by an arrow $a': j \rightarrow i$. By the same reasoning as in Proposition 8.2, after applying the mutation sequence formed by all bi-fundamental Baxter operators $Q_{d_i,\bullet}$ needed to reverse the orientation of all edges $a \in \Gamma_1$ with i as

³In fact, $m_{\text{frozen}} = 1$ unless the vertex i is the basepoint of Γ , in which case it is equal to $A_{\text{basepoint}}^{-1}$

their source followed by the Dehn twist $\tau_i^{d_i-m}$, the dressed monopole operator E_{i,x^m} becomes the element

$$\exp \left(2\pi b \left(x_{i,1} - \underline{p}_{i,\bullet} + \sum_{i \rightarrow j} \left(\underline{p}_{j,\bullet} - d_j p_{i,1} \right) \right) \right),$$

which coincides with the cluster monomial

$$Y' \left(e_0^{(i)} + \mathbf{d} \sum_{k=1}^{2(d_i-1)} e_k^{(i)} + \sum_{a \in \Gamma_1, a: i \rightarrow j} \left\{ d_j e^{(a)} + \sum_{k=1}^{d_j-1} (d_j - k) \left(e_{2k-1}^{(j)} + e_{2k}^{(j)} \right) \right\} \right)$$

in the cluster obtained from the initial one by applying these mutations. Here we have set

$$\mathbf{d} = \sum_{a \in \Gamma_1, a: i \rightarrow j} d_j,$$

and the notation Y' refers to the fact that the formula above refers to the basis obtained from the initial one by our sequence of mutations. Under the extended ensemble map, this monomial coincides with the A -variable $A'(e_1^{(i)} - \mathbf{d}e_0^{(i)})$, which is universally Laurent since $A(e_0^{(i)})$ is a frozen A -variable. This proves that the monopole operator $E_i; x^m$ is universally Laurent; by the same argument in which we apply Baxter operators to reverse the orientation of all edges $a \in \Gamma_1$ with i as their target, we see that the same is true of $F_{i;x^m}$. Since the subalgebra $K_{\widehat{GL}(V) \times T_F \times \tilde{C}^*}(\text{pt})$ is universally Laurent by Lemma 8.1, the Theorem is proved. \square

9. EXAMPLES

In this section, we give examples of our construction. Given a partition

$$n = n_1 + \cdots + n_k$$

of a number $n \in \mathbb{Z}_{>0}$, one can consider a conjugation orbit $\mathcal{O}_\sigma \subset SL(n, \mathbb{C})$, where $\sigma = (n_1, \dots, n_k)$, through a diagonal matrix with eigenvalues λ_i , $1 \leq i \leq k$, so that the multiplicity of λ_i is n_i . Fixing a partition σ , we can consider a family of closures $\overline{\mathcal{O}_\sigma}$ of conjugation orbits in $SL(n, \mathbb{C})$, as the eigenvalues λ_i vary. Denote by \mathcal{F}_σ the affinization of the pre-image in the multiplicative Grothendieck-Springer resolution of the intersection of the named family with the open cell in $SL(n, \mathbb{C})$ with the dual Poisson-Lie structure. The four examples presented below describe cluster structure on the varieties \mathcal{F}_σ for $n = 4$. The Coulomb quivers for these slices can be found in the last row of Figure 4 in [HK19]. In particular, the (quantum) cluster structure on $\mathcal{F}_{(4)}$, coincides with that on (the locally finite part of) the quantum group $U_q(\mathfrak{sl}_4)$ after one takes S_4 -invariants. Throughout this section, we draw gauge nodes as circles, flavor nodes as squares, shade the marked gauge node, and write dimensions of the corresponding spaces inside the nodes.

A rigged Coulomb quiver $\Gamma_{(4)}^\dagger$ for the variety $\mathcal{F}_{(4)}$ is shown on Figure 8. According to our recipe, the corresponding cluster quiver $\mathcal{Q}_{(4)}^\dagger$ is as on Figure 12. The label

homomorphism reads as follows. The non-frozen vertices in Coxeter parts of the quiver read

$$\begin{aligned} y_3 &\mapsto x_{2,2} - x_{2,1}, & y_4 &\mapsto p_{2,1} - p_{2,2} + x_{2,1} - x_{2,2}, \\ y_8 &\mapsto x_{3,3} - x_{3,2}, & y_9 &\mapsto p_{3,2} - p_{3,3} + x_{3,2} - x_{3,3}, \\ y_{10} &\mapsto x_{3,2} - x_{3,1}, & y_{11} &\mapsto p_{3,1} - p_{3,2} + x_{3,1} - x_{3,2}, \end{aligned}$$

while the frozen ones are

$$y_1 \mapsto x_{1,1} - p_{1,1}, \quad y_5 \mapsto x_{2,1} - p_{2,1} - p_{2,2}, \quad y_{12} \mapsto x_{3,1} - p_{3,1} - p_{3,2} - p_{3,3}.$$

The framing node gives rise to

$$y_{13} \mapsto z_1 - p_{3,1}, \quad y_{14} \mapsto z_2 - p_{3,1}, \quad y_{15} \mapsto z_3 - p_{3,1}, \quad y_{16} \mapsto z_4 - p_{3,1},$$

and finally the marked vertex yields

$$y_7 \mapsto p_{3,3}.$$

In a similar fashion, rigged Coulomb quivers $\Gamma_{(3,1)}^\dagger$, $\Gamma_{(2,2)}^\dagger$, $\Gamma_{(2,1,1)}^\dagger$, and the corresponding cluster quivers $\mathcal{Q}_{(3,1)}^\dagger$, $\mathcal{Q}_{(2,2)}^\dagger$, $\mathcal{Q}_{(2,1,1)}^\dagger$ are shown in Figures 9, 10, 11, and Figures 13, 14, 15 respectively. The label homomorphism in the case of $\mathcal{F}_{(2,1,1)}$ reads as follows (since every node of the Coulomb quiver is of dimension 1, we omit the second index):

$$\begin{aligned} y_1 &\mapsto x_1 - p_1, & y_2 &\mapsto z_1 - p_1, & y_3 &\mapsto p_2 - p_1, \\ y_4 &\mapsto x_2 - p_2, & y_5 &\mapsto p_3 - p_2, & y_6 &\mapsto p_3, \\ y_7 &\mapsto x_3 - p_3, & y_8 &\mapsto z_3 - p_3. \end{aligned}$$

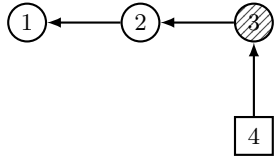

FIGURE 8. Quiver $\Gamma_{(4)}^\dagger$.

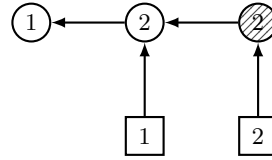

FIGURE 9. Quiver $\Gamma_{(3,1)}^\dagger$.

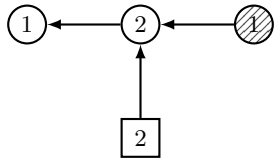

FIGURE 10. Quiver $\Gamma_{(2,2)}^\dagger$.

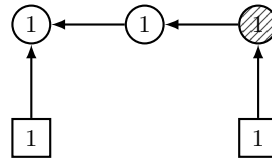

FIGURE 11. Quiver $\Gamma_{(2,1,1)}^\dagger$.

In order to describe the cluster algebra elements corresponding to the monopole operators, it will be useful to introduce the following notation: if $(\lambda_0, \lambda_1, \dots, \lambda_M)$ is a

sequence of lattice elements $\lambda_i \in \Lambda$, we write

$$Y(\lambda_0; \lambda_1, \dots, \lambda_M) := Y(\lambda_0) + Y(\lambda_0 - \lambda_1) + Y(\lambda_0 - \lambda_1 - \lambda_2) + \dots + Y\left(\lambda_0 - \sum_{k=1}^M \lambda_k\right).$$

And given a subset of vertices S , we write

$$\mathcal{E}_k(\lambda, J) = \sum_{J \subseteq S, |J|=k} Y\left(\lambda - \sum_{r \in J} e_r\right).$$

Then we have

$$\begin{aligned} E_{1;x-1}^{(4)} &\mapsto q^3 Y(e_2), \\ E_{2;x-2}^{(4)} &\mapsto q^4 Y(e_6; e_3), \\ E_{3;x-3}^{(4)} &\mapsto q^5 Y(e_{12}; e_7, e_5, e_4, e_7, e_9), \end{aligned}$$

while

$$\begin{aligned} q^{-1} F_{1;x-1}^{(4)} &\mapsto q Y(-e_2; e_3, e_5, e_4, e_3), \\ -F_{2;x-1}^{(4)} &\mapsto Y(-e_4 - e_5 - e_6; e_5, e_7, e_9, e_8, e_{11}, e_{10}) \\ &\quad + Y(-e_4 - 2e_5 - e_6 - 2e_7 - e_8 - e_9 - e_{11}; \underline{e}_{10}, e_9, e_8, e_7, e_4), \\ q F_{3;x-1}^{(4)} &\mapsto Y(\underline{e}^{(4)}; e_8, e_{11}) + (q + q^{-1}) Y(\underline{e}^{(4)} - e_8 - e_{10} - e_{11}) \\ &\quad + Y(\underline{e}^{(4)} - e_8 - 2e_{10} - e_{11}) + \mathcal{E}_1(\underline{e}^{(4)} - e_8 - e_{10} - e_{11}, J^{(4)}) \\ &\quad + \sum_{k=0}^4 \mathcal{E}_k(\underline{e}^{(4)} - e_8 - 2e_{10} - e_{11}, J^{(4)}), \end{aligned}$$

where we set $\underline{e}^{(4)} = -2e_8 - 2e_9 - e_{10} - e_{11} - e_{12}$ and $J^{(4)} = \{13, 14, 15, 16\}$.

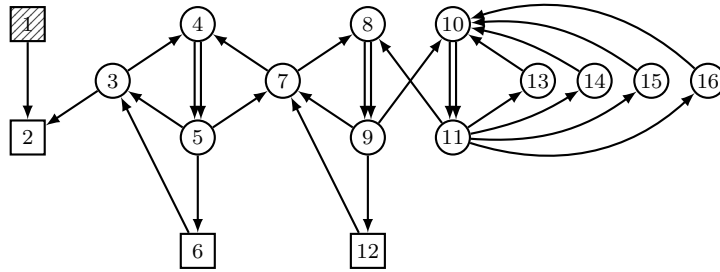

FIGURE 12. Cluster quiver $\mathcal{Q}_{(4)}^\dagger$.

Similarly, in the case of the partition (3, 1) we have

$$\begin{aligned} E_{1;x^{-1}}^{(3,1)} &\mapsto q^3 Y(e_2), \\ E_{2;x^{-2}}^{(3,1)} &\mapsto q^4 Y(e_6; e_3), \\ E_{3;x^{-2}}^{(3,1)} &\mapsto q^4 Y(e_{11}; e_8, e_5, e_4, e_8, e_{10}), \end{aligned}$$

and

$$\begin{aligned} q^{-1} F_{1;x^{-1}}^{(3,1)} &\mapsto Y(-e_2; e_3, e_5, e_4, e_3), \\ -F_{2;x^{-1}}^{(3,1)} &\mapsto Y(-e_4 - e_5 - e_6; e_5, e_7, e_8, e_{10}, e_9) \\ &\quad + Y(-e_4 - 2e_5 - e_6 - e_8; e_{10}, e_9, e_8, e_7, e_4), \\ -F_{3;x^{-1}}^{(3,1)} &\mapsto \sum_{k=0}^2 \mathcal{E}_k(-e_9 - e_{11}, \{12, 13\}). \end{aligned}$$

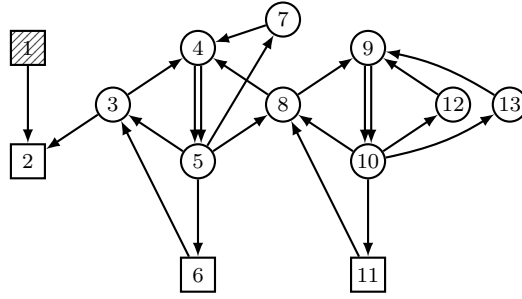

FIGURE 13. Cluster quiver $Q_{(3,1)}^\dagger$.

In the case of the partition (2, 2), we have

$$\begin{aligned} E_{1;x^{-1}}^{(2,2)} &\mapsto q^3 Y(e_2), \\ E_{2;x^{-2}}^{(2,2)} &\mapsto q^4 Y(e_6; e_3), \\ E_{3;x^{-1}}^{(2,2)} &\mapsto q^3 Y(e_{10}; e_9, e_5, e_4, e_9), \end{aligned}$$

while

$$\begin{aligned} q^{-1} F_{1;x^{-1}}^{(2,2)} &\mapsto Y(-e_2; e_3, e_5, e_4, e_3), \\ -F_{2;x^{-1}}^{(2,2)} &\mapsto Y(-e_4 - e_5 - e_6) + Y(-2e_4 - 2e_5 - e_6 - e_7 - e_8) \\ &\quad + \sum_{k=0}^2 \mathcal{E}_k(-e_4 - 2e_5 - e_6 - e_9, \{7, 8\}) + \sum_{k=0}^2 \mathcal{E}_k(-e_4 - 2e_5 - e_6, \{7, 8\}), \\ q^{-1} F_{3;x^{-1}}^{(2,2)} &\mapsto Y(-e_{10}). \end{aligned}$$

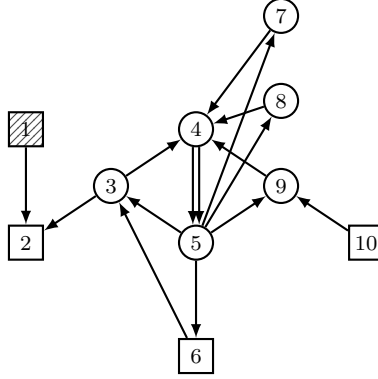
FIGURE 14. Cluster quiver $\mathcal{Q}_{(2,2)}^\dagger$.

And in the case of $(2, 1, 1)$, we have

$$\begin{aligned} E_{1;x^{-1}}^{(2,1,1)} &\mapsto q^3 Y(e_2), & F_{1;x^{-1}}^{(2,1,1)} &\mapsto qY(-e_2; e_3), \\ E_{2;x^{-1}}^{(2,1,1)} &\mapsto q^3 Y(e_5), & F_{2;x^{-1}}^{(2,1,1)} &\mapsto qY(-e_5), \\ E_{3;x^{-1}}^{(2,1,1)} &\mapsto q^3 Y(e_7), & F_{3;x^{-1}}^{(2,1,1)} &\mapsto qY(-e_7; e_8). \end{aligned}$$

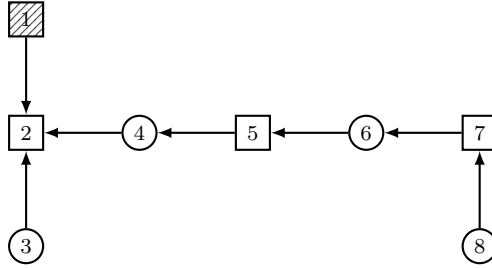
FIGURE 15. Cluster quiver $\mathcal{Q}_{(2,1,1)}^\dagger$.

REFERENCES

- [BFM05] R. Bezrukavnikov, M. Finkelberg, I. Mirković. “Equivariant homology and K -theory of affine Grassmannians and Toda lattices.” *Compositio Mathematica* 141, no. 3 (2005): 746-768.
- [BFN16] A. Braverman, M. Finkelberg, H. Nakajima. “Towards a mathematical definition of Coulomb branches of 3-dimensional $\mathcal{N} = 4$ gauge theories, II.” *arXiv:1601.03586* (2016).
- [BZ05] A. Berenstein, A. Zelevinsky. “Quantum cluster algebras.” *Advances in Mathematics* 195, no. 2 (2005): 405-455.
- [CW19] S. Cautis, H. Williams. “Cluster theory of the coherent Satake category.” *Journal of the American Mathematical Society* 32, no. 3 (2019): 709-778.
- [DFK17] P. Di Francesco, R. Kedem. “ (t, q) Q-systems, DAHA and quantum toroidal algebras via generalized Macdonald operators.” *arXiv:1704.00154* (2017).
- [FG09a] V. Fock, A. Goncharov. “Cluster ensembles, quantization and the dilogarithm.” *Annales scientifiques de l’École Normale Supérieure* 42, no. 6 (2009): 865-930.

- [FG09b] V. Fock, A. Goncharov. “The quantum dilogarithm and representations of quantum cluster varieties.” *Inventiones mathematicae* 175, no. 2 (2009): 223-286.
- [FK94] L. Faddeev, R. Kashaev. “Quantum dilogarithm.” *Modern Physics Letters A* 9.05 (1994): 427-434.
- [FT17] M. Finkelberg, A. Tsymbaliuk. “Multiplicative slices, relativistic Toda and shifted quantum affine algebras.” *arXiv:1708.01795* (2017).
- [FT19] M. Finkelberg, A. Tsymbaliuk. “Shifted Quantum Affine Algebras: Integral Forms in Type A.” *Arnold Mathematical Journal* (2019): 1-87.
- [Giv97] A. Givental. “Stationary phase integrals, quantum Toda lattices, flag manifolds and the mirror conjecture”. *American Mathematical Society Translations: Series 2* 180 (1997): 103-115.
- [GKLO06] A. Gerasimov, S. Kharchev, D. Lebedev, S. Oblezin. “On a Gauss-Givental representation for quantum Toda chain wave function.” *International Mathematics Research Notices* 2006 (2006).
- [HK19] A. Hanany, R. Kalveks. “Quiver Theories and Hilbert Series of Classical Slodowy Intersections.” *arXiv:1909.12793* (2019).
- [Kas01] R. Kashaev. “The Quantum Dilogarithm and Dehn Twists in Quantum Teichmüller Theory.” *Integrable Structures of Exactly Solvable Two-Dimensional Models of Quantum Field Theory*, vol. 35 (2001): 211-221.
- [Kel] B. Keller. <https://webusers.imj-prg.fr/~bernhard.keller/quivermutation/>
- [KLS02] S. Kharchev, D. Lebedev, M. Semenov-Tian-Shansky. “Unitary Representations of $U_q(SL(2, \mathbb{R}))$, the Modular Double and the Multiparticle q -Deformed Toda Chain.” *Communications in mathematical physics* 225, no. 3 (2002): 573-609.
- [Nak15] H. Nakajima. “Towards a mathematical definition of Coulomb branches of 3-dimensional $\mathcal{N} = 4$ gauge theories, I.” *arXiv:1503.03676* (2015).
- [NW19] H. Nakajima, A. Weekes. “Coulomb branches of quiver gauge theories with symmetrizers.” *arXiv:1907.06552* (2019).
- [SS18] G. Schrader, A. Shapiro. “On b -Whittaker functions.” *arXiv:1806.00747* (2018).
- [SS19] G. Schrader, A. Shapiro. “A cluster realization of the $U_q(\mathfrak{sl}_n)$ from quantum character varieties.” *Inventiones Mathematicae* 216, no. 3 (2019): 799-846.
- [Wee19] A. Weekes. “Generators for Coulomb branches of quiver gauge theories.” *arXiv:1903.07734* (2019).