

Formally Verified Hardware/Software Co-Design for Remote Attestation

Ivan De Oliveira Nunes
University of California, Irvine
ivanoliv@uci.edu

Karim Eldefrawy
SRI International
karim.eldefrawy@sri.com

Norrathep Rattanavipanon
University of California, Irvine
nrattana@uci.edu

Michael Steiner
Intel
michael.steiner@intel.com

Gene Tsudik
University of California, Irvine
gene.tsudik@uci.edu

Abstract

Remote Attestation (RA) is a distinct security service that allows a trusted verifier (\mathcal{V}_{rf}) to measure the software state of an untrusted remote prover (\mathcal{P}_{rv}). If correctly implemented, RA allows \mathcal{V}_{rf} to remotely detect if \mathcal{P}_{rv} is in an illegal or compromised state. Although several RA approaches have been explored (including hardware-based, software-based, and hybrid) and many concrete methods have been proposed, comparatively little attention has been devoted to formal verification. In particular, thus far, no RA designs and no implementations have been formally verified with respect to claimed security properties.

In this work, we take the first step towards formal verification of RA by designing and verifying an architecture called *VRASED*: Verifiable Remote Attestation for Simple Embedded Developments. *VRASED* instantiates a hybrid (HW/SW) RA co-design aimed at low-end embedded systems, e.g., simple IoT devices. *VRASED* provides a level of security comparable to HW-based approaches, while relying on SW to minimize additional HW costs. Since security properties must be jointly guaranteed by HW and SW, verification is a challenging task, which has never been attempted before in the context of RA. We believe that *VRASED* is the first formally verified RA scheme. To the best of our knowledge, it is also the first formal verification of a HW/SW implementation of any security service. To demonstrate *VRASED*'s practicality and low overhead, we instantiate and evaluate it on a commodity platform (TI MSP430). *VRASED*'s publicly available implementation was deployed on the Basys3 FPGA.

1 Introduction

The number and variety of special-purpose computing devices is increasing dramatically. This includes all kinds of embedded devices, cyber-physical systems (CPS) and Internet-of-Things (IoT) gadgets, that are utilized in various “smart” settings, such as homes, offices, factories, automotive systems and public venues. As society becomes increasingly accustomed to being surrounded by, and dependent on, such devices, their security becomes extremely important. For actuation-capable devices,

malware can impact both security and safety, e.g., as demonstrated by Stuxnet [48]. Whereas, for sensing devices, malware can undermine privacy by obtaining ambient information. Furthermore, clever malware can turn vulnerable IoT devices into zombies that can become sources for DDoS attacks. For example, in 2016, a multitude of compromised “smart” cameras and DVRs formed the Mirai Botnet [2] which was used to mount a massive-scale DDoS attack (the largest in history).

Unfortunately, security is typically not a key priority for low-end device manufacturers, due to cost, size or power constraints. It is thus unrealistic to expect such devices to have the means to prevent current and future malware attacks. The next best thing is detection of malware presence. This typically requires some form of **Remote Attestation** (RA) – a distinct security service for detecting malware on CPS, embedded and IoT devices. RA is especially applicable to low-end embedded devices that are incapable of defending themselves against malware infection. This is in contrast to more powerful devices (both embedded and general-purpose) that can avail themselves of sophisticated anti-malware protection. RA involves verification of current internal state (i.e., RAM and/or flash) of an untrusted remote hardware platform (prover or \mathcal{P}_{rv}) by a trusted entity (verifier or \mathcal{V}_{rf}). If \mathcal{V}_{rf} detects malware presence, \mathcal{P}_{rv} 's software can be re-set or rolled back and out-of-band measures can be taken to prevent similar infections. In general, RA can help \mathcal{V}_{rf} establish a static or dynamic root of trust in \mathcal{P}_{rv} and can also be used to construct other security services, such as software updates [42] and secure deletion [39]. Hybrid RA (implemented as a HW/SW co-design) is a particularly promising approach for low-end embedded devices. It aims to provide the same security guarantees as (more expensive) hardware-based approaches, while minimizing modifications to the underlying hardware.

Even though numerous RA techniques with different assumptions, security guarantees, and designs, have been proposed [9, 10, 14–16, 19, 20, 24, 29, 34, 37, 37–39, 42], a major missing aspect of RA is the high-assurance and rigor derivable from utilizing (automated) formal verification to guarantee security of the design and implementation of RA techniques. Because all aforementioned architectures and their implementations are not systematically designed from abstract models, their soundness and security can not be formally argued. In fact, our RA verification efforts revealed that a previous hybrid

To appear: **USENIX Security 2019**.
Title: **VRASED: A Verified Hardware/Software Co-Design for Remote Attestation**

RA design – SMART [20] – assumed that disabling interrupts is an atomic operation and hence opened the door to compromise of \mathcal{P}_{rv} 's secret key in the window between the time of the invocation of disable interrupts functionality and the time when interrupts are actually disabled. Another low/medium-end architecture – Trustlite [29] – also does not achieve our formal definition of RA soundness. In particular, this architecture is vulnerable to self-relocating malware (See [13] for details). Formal specification of RA properties and their (automated) verification significantly increases our confidence that such subtle issues are not overlooked.

In this paper we take a “verifiable-by-design” approach and develop, from scratch, an architecture for **V**erifiable **R**emote **A**ttestation for **S**imple **E**mbedded **D**eveloped (*VRASED*). *VRASED* is the first formally specified and verified RA architecture accompanied by a formally verified implementation. Verification is carried out for all trusted components, including hardware, software, and the composition of both, all the way up to end-to-end notions for RA soundness and security. The resulting verified implementation – along with its computer proofs – is publicly available [1]. Formally reasoning about, and verifying, *VRASED* involves overcoming major challenges that have not been attempted in the context of RA and, to the best of our knowledge, not attempted for any security service implemented as a HW/SW co-design. These challenges include:

1 – Formal definitions of: (i) end-to-end notions for RA soundness and security; (ii) a realistic machine model for low-end embedded systems; and (iii) *VRASED*'s guarantees. These definitions must be made in single formal system that is powerful enough to provide a common ground for reasoning about their interplay. In particular, our end goal is to prove that the definitions for RA soundness and security are implied by *VRASED*'s guarantees when applied to our machine model. Our formal system of choice is Linear Temporal Logic (LTL). A background on LTL and our reasons for choosing it are discussed in Section 2.

2 – Automatic end-to-end verification of complex systems such as *VRASED* is challenging from the computability perspective, as the space of possible states is extremely large. To cope with this challenge, we take a “divide-to-conquer” approach. We start by dividing the end-to-end goal of RA soundness and security into smaller sub-properties that are also defined in LTL. Each HW sub-module, responsible for enforcing a given sub-property, is specified as a Finite State Machine (FSM), and verified using a Model Checker. *VRASED*'s SW relies on an F^* verified implementation (see Section 4.3) which is also specified in LTL. This modular approach allows us to efficiently prove sub-properties enforced by individual building blocks in *VRASED*.

3 – All proven sub-properties must be composed together in order to reason about RA security and soundness of *VRASED* as one whole system. To this end, we use a theorem prover

to show (by using LTL equivalences) that the sub-properties that were proved for each of *VRASED*'s sub-modules, when composed, imply the end-to-end definitions of RA soundness and security. This modular approach enables efficient system-wide formal verification.

1.1 The Scope of Low-End Devices

This work focuses on low-end devices based on low-power single core microcontrollers with a few KBytes of program and data memory. A representative of this class of devices is the Texas Instrument's MSP430 microcontroller (MCU) family [25]. It has a 16-bit word size, resulting in ≈ 64 KBytes of addressable memory. SRAM is used as data memory and its size ranges between 4 and 16KBytes (depending on the specific MSP430 model), while the rest of the address space is used for program memory, e.g., ROM and Flash. MSP430 is a Von Neumann architecture processor with common data and code address spaces. It can perform multiple memory accesses within a single instruction; its instruction execution time varies from 1 to 6 clock cycles, and instruction length varies from 16 to 48 bits. MSP430 was designed for low-power and low-cost. It is widely used in many application domains, e.g., automotive industry, utility meters, as well as consumer devices and computer peripherals. Our choice is also motivated by availability of a well-maintained open-source MSP430 hardware design from Open Cores [21]. Nevertheless, our machine model is applicable to other low-end MCUs in the same class as MSP430 (e.g., Atmel AVR ATMega).

1.2 Organization

Section 2 provides relevant background on RA and automated verification. Section 3 contains the details of the *VRASED* architecture and an overview of the verification approach. Section 4 contains the formal definitions of end-to-end RA soundness and security and the formalization of the necessary sub-properties along with the implementation of verified components to realize such sub-properties. Due to space limitation, the proofs for end-to-end soundness and security derived from the sub-properties are discussed in Appendix A. Section 5 discusses alternative designs to guarantee the same required properties and their trade-offs with the standard design. Section 6 presents experimental results demonstrating the minimal overhead of the formally verified and synthesized components. Section 7 discusses related work. Section 8 concludes with a summary of our results. End-to-end proofs of soundness and security, optional parts of the design, *VRASED*'s API, and discussion on *VRASED*'s prototype can be found in Appendices A to D.

2 Background

This section overviews RA and provides some background on computer-aided verification.

2.1 RA for Low-end Devices

As mentioned earlier, RA is a security service that facilitates detection of malware presence on a remote device. Specifically, it allows a trusted verifier ($\mathcal{V}rf$) to remotely measure the software state of an untrusted remote device ($\mathcal{P}rv$). As shown in Figure 1, RA is typically obtained via a simple challenge-response protocol:

1. $\mathcal{V}rf$ sends an attestation request containing a challenge ($\mathcal{C}hal$) to $\mathcal{P}rv$. This request might also contain a token derived from a secret that allows $\mathcal{P}rv$ to authenticate $\mathcal{V}rf$.
2. $\mathcal{P}rv$ receives the attestation request and computes an *authenticated integrity check* over its memory and $\mathcal{C}hal$. The memory region might be either pre-defined, or explicitly specified in the request. In the latter case, authentication of $\mathcal{V}rf$ in step (1) is paramount to the overall security/privacy of $\mathcal{P}rv$, as the request can specify arbitrary memory regions.
3. $\mathcal{P}rv$ returns the result to $\mathcal{V}rf$.
4. $\mathcal{V}rf$ receives the result from $\mathcal{P}rv$, and checks whether it corresponds to a valid memory state.

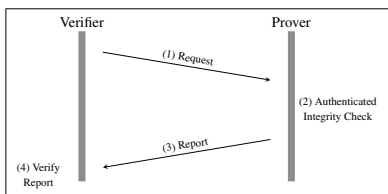

Figure 1: Remote attestation (RA) protocol

The *authenticated integrity check* can be realized as a Message Authentication Code (MAC) over $\mathcal{P}rv$'s memory. However, computing a MAC requires $\mathcal{P}rv$ to have a unique secret key (denoted by \mathcal{K}) shared with $\mathcal{V}rf$. This \mathcal{K} must reside in secure storage, where it is **not** accessible to any software running on $\mathcal{P}rv$, except for attestation code. Since most RA threat models assume a fully compromised software state on $\mathcal{P}rv$, secure storage implies some level of hardware support.

Prior RA approaches can be divided into three groups: software-based, hardware-based, and hybrid. Software-based (or timing-based) RA is the only viable approach for legacy devices with no hardware security features. Without hardware support, it is (currently) impossible to guarantee that \mathcal{K} is not accessible by malware. Therefore, security of software-based approaches [34, 43] is attained by setting threshold communication delays between $\mathcal{V}rf$ and $\mathcal{P}rv$. Thus, software-based RA is unsuitable for multi-hop and jitter-prone communication, or settings where a compromised $\mathcal{P}rv$ is aided (during attestation) by a more powerful accomplice device. It also requires strong constraints and assumptions on the hardware platform and attestation usage [30, 33]. On the other extreme, hardware-based approaches require either i) $\mathcal{P}rv$'s attestation functionality to be housed entirely within dedicated hardware, e.g., Trusted Platform Modules (TPMs) [46]; or ii) modifications to the

CPU semantics or instruction sets to support the execution of trusted software, e.g., SGX [26] or TrustZone [3]. Such hardware features are too expensive (in terms of physical area, energy consumption, and actual cost) for low-end devices.

While neither hardware- nor software-based approaches are well-suited for settings where low-end devices communicate over the Internet (which is often the case in the IoT), hybrid RA (based on HW/SW co-design) is a more promising approach. Hybrid RA aims at providing the same security guarantees as hardware-based techniques with minimal hardware support. SMART [20] is the first hybrid RA architecture targeting low-end MCUs. In SMART, attestation's integrity check is implemented in software. SMART's small hardware footprint guarantees that the attestation code runs safely and that the attestation key is not leaked. HYDRA [19] is a hybrid RA scheme that relies on a secure boot hardware feature and on a secure micro-kernel. Trustlite [29] modifies Memory Protection Unit (MPU) and CPU exception engine hardware to implement RA. Tytan [9] is built on top of Trustlite, extending its capabilities for applications with real-time requirements.

Despite much progress, a major missing aspect in RA research is high-assurance and rigor obtained by using formal methods to guarantee security of a concrete RA design and its implementation. We believe that verifiability and formal security guarantees are particularly important for hybrid RA designs aimed at low-end embedded and IoT devices, as their proliferation keeps growing. This serves as the main motivation for our efforts to develop the first formally verified RA architecture.

2.2 Formal Verification, Model Checking & Linear Temporal Logic

Computer-aided formal verification typically involves three basic steps. First, the system of interest (e.g., hardware, software, communication protocol) must be described using a formal model, e.g., a Finite State Machine (FSM). Second, properties that the model should satisfy must be formally specified. Third, the system model must be checked against formally specified properties to guarantee that the system retains such properties. This checking can be achieved via either Theorem Proving or Model Checking. In this work, we use the latter and our motivation for picking it is clarified below.

In Model Checking, properties are specified as *formulae* using Temporal Logic and system models are represented as FSMs. Hence, a system is represented by a triple (S, S_0, T) , where S is a finite set of states, $S_0 \subseteq S$ is the set of possible initial states, and $T \subseteq S \times S$ is the transition relation set, i.e., it describes the set of states that can be reached in a single step from each state. The use of Temporal Logic to specify properties allows representation of expected system behavior over time.

We apply the model checker NuSMV [17], which can be

used to verify generic HW or SW models. For digital hardware described at Register Transfer Level (RTL) – which is the case in this work – conversion from Hardware Description Language (HDL) to NuSMV model specification is simple. Furthermore, it can be automated [27]. This is because the standard RTL design already relies on describing hardware as an FSM.

In NuSMV, properties are specified in Linear Temporal Logic (LTL), which is particularly useful for verifying sequential systems. This is because it extends common logic statements with temporal clauses. In addition to propositional connectives, such as conjunction (\wedge), disjunction (\vee), negation (\neg), and implication (\rightarrow), LTL includes temporal connectives, thus enabling sequential reasoning. We are interested in the following temporal connectives:

- $\mathbf{X}\phi$ – $\text{neXt } \phi$: holds if ϕ is true at the next system state.
- $\mathbf{F}\phi$ – $\text{Future } \phi$: holds if there exists a future state where ϕ is true.
- $\mathbf{G}\phi$ – $\text{Globally } \phi$: holds if for all future states ϕ is true.
- $\phi \mathbf{U} \psi$ – $\phi \text{ Until } \psi$: holds if there is a future state where ψ holds and ϕ holds for all states prior to that.

This set of temporal connectives combined with propositional connectives (with their usual meanings) allows us to specify powerful rules. NuSMV works by checking LTL specifications against the system FSM for all reachable states in such FSM. In particular, all *VRASED*'s desired security sub-properties are specified using LTL and verified by NuSMV.

3 Overview of VRASED

VRASED is composed of a HW module (HW-Mod) and a SW implementation (SW-Att) of *Prv*'s behavior according to the RA protocol. HW-Mod enforces access control to \mathcal{K} in addition to secure and atomic execution of SW-Att (these properties are discussed in detail below). HW-Mod is designed with minimality in mind. The verified FSMs contain a minimal state space, which keeps hardware cost low. SW-Att is responsible for computing an attestation report. As *VRASED*'s security properties are jointly enforced by HW-Mod and SW-Att, both must be verified to ensure that the overall design conforms to the system specification.

3.1 Adversarial Capabilities & Verification Axioms

We consider an adversary, \mathcal{A} , that can control the entire software state, code, and data of *Prv*. \mathcal{A} can modify any writable memory and read any memory that is not explicitly protected by access control rules, i.e., it can read anything (including secrets) that is not explicitly protected by HW-Mod. It can also re-locate malware from one memory segment to another, in order to hide it from being detected. \mathcal{A} may also have full control over all Direct Memory Access (DMA) controllers on *Prv*.

DMA allows a hardware controller to directly access main memory (e.g., RAM, flash or ROM) without going through the CPU.

We focus on attestation functionality of *Prv*; verification of the entire MCU architecture is beyond the scope of this paper. Therefore, we assume the MCU architecture strictly adheres to, and correctly implements, its specifications. In particular, our verification approach relies on the following simple axioms:

- **A1 - Program Counter:** The program counter (*PC*) always contains the address of the instruction being executed in a given cycle.
- **A2 - Memory Address:** Whenever memory is read or written, a data-address signal (D_{addr}) contains the address of the corresponding memory location. For a read access, a data read-enable bit (R_{en}) must be set, and for a write access, a data write-enable bit (W_{en}) must be set.
- **A3 - DMA:** Whenever a DMA controller attempts to access main system memory, a DMA-address signal (DMA_{addr}) reflects the address of the memory location being accessed and a DMA-enable bit (DMA_{en}) must be set. DMA can not access memory when DMA_{en} is off (logical zero).
- **A4 - MCU reset:** At the end of a successful *reset* routine, all registers (including *PC*) are set to zero before resuming normal software execution flow. Resets are handled by the MCU in hardware; thus, reset handling routine can not be modified.
- **A5 - Interrupts:** When interrupts happen, the corresponding *irq* signal is set.

Remark: Note that Axioms A1 to A5 are satisfied by the OpenMSP430 design.

SW-Att uses the HACLS* [51] HMAC-SHA256 function which is implemented and verified in F*¹. F* can be automatically translated to C and the proof of correctness for the translation is provided in [40]. However, even though efforts have been made to build formally verified C compilers (CompCert [32] is the most prominent example), there are currently no verified compilers targeting lower-end MCUs, such as MSP430. Hence, we assume that the standard compiler can be trusted to semantically preserve its expected behavior, especially with respect to the following:

- **A6 - Callee-Saves-Register:** Any register touched in a function is cleaned by default when the function returns.
- **A7 - Semantic Preservation:** Functional correctness of the verified HMAC implementation in C, when converted to assembly, is semantically preserved.

Remark: Axioms A6 and A7 reflect the corresponding compiler specification (e.g., *msp430-gcc*).

Physical hardware attacks are out of scope in this paper. Specifically, \mathcal{A} can not modify code stored in ROM, induce hardware faults, or retrieve *Prv* secrets via physical presence side-channels. Protection against physical attacks is consid-

¹<https://www.fstar-lang.org/>

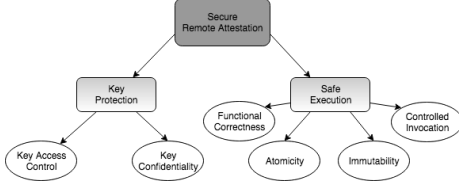

Figure 2: Properties of secure RA.

ered orthogonal and could be supported via standard tamper-resistance techniques [41].

3.2 High-Level Properties of Secure Attestation

We now describe, in high level, the sub-properties required for RA. In section 4, we formalize these sub-properties in LTL and provide single end-to-end definitions for RA soundness and security. Then we prove that *VRASED*'s design satisfies the aforementioned sub-properties and that the end-to-end definitions for soundness and security are implied by them. The properties, shown in Figure 2, fall into two groups: *key protection* and *safe execution*.

Key Protection:

As mentioned earlier, \mathcal{K} must not be accessible by regular software running on $\mathcal{P}rv$. To guarantee this, the following features must be correctly implemented:

- **P1- Access Control:** \mathcal{K} can only be accessed by SW-Att.
- **P2- No Leakage:** Neither \mathcal{K} (nor any function of \mathcal{K} other than the correctly computed HMAC) can remain in unprotected memory or registers after execution of SW-Att.
- **P3- Secure Reset:** Any memory tainted by \mathcal{K} and all registers (including PC) must be erased (or be inaccessible to regular software) after MCU reset. Since a reset might be triggered during SW-Att execution, lack of this property could result in leakage of privileged information about the system state or \mathcal{K} . Erasure of registers as part of the reset ensures that no state from a previous execution persists. Therefore, the system must return to the default initialization state.

Safe Execution:

Safe execution ensures that \mathcal{K} is properly and securely used by SW-Att for its intended purpose in the RA protocol. Safe execution can be divided into four sub-properties:

- **P4- Functional Correctness:** SW-Att must implement expected behavior of $\mathcal{P}rv$'s role in the RA protocol. For instance, if $\mathcal{V}rf$ expects a response containing an HMAC of memory in address range $[A, B]$, SW-Att implementation should always reply accordingly. Moreover, SW-Att must always finish in finite time, regardless of input size and other parameters.

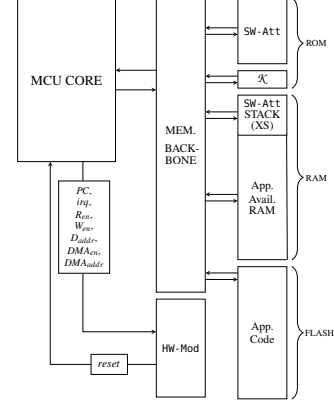

Figure 3: VRASED system architecture

- **P5- Immutability:** SW-Att executable must be immutable. Otherwise, malware residing in $\mathcal{P}rv$ could modify SW-Att, e.g., to always generate valid RA measurements or to leak \mathcal{K} .
- **P6- Atomicity:** SW-Att execution can not be interrupted. The first reason for atomicity is to prevent leakage of intermediate values in registers and SW-Att's data memory (including locations that could leak functions of \mathcal{K}) during SW-Att execution. This relates to **P2** above. The second reason is to prevent roving malware from relocating itself to escape being measured by SW-Att.
- **P7- Controlled Invocation:** SW-Att must always start from the first instruction and execute until the last instruction. Even though correct implementation of SW-Att is guaranteed by **P4**, isolated execution of chunks of a correctly implemented code could lead to catastrophic results. Potential ROP attacks could be constructed using gadgets of SW-Att (which, based on **P1**, have access to \mathcal{K}) to compute valid attestation results.

Beyond aforementioned core security properties, in some settings, $\mathcal{P}rv$ might need to authenticate $\mathcal{V}rf$'s attestation requests in order to mitigate potential DoS attacks on $\mathcal{P}rv$. This functionality is also provided (and verified) as an optional feature in the design of *VRASED*. The differences between the standard design and the one with support for $\mathcal{V}rf$ authentication are discussed in Appendix B.

3.3 System Architecture

VRASED architecture is depicted in Figure 3. *VRASED* is implemented by adding HW-Mod to the MCU architecture, e.g., MSP430. MCU memory layout is extended to include Read-Only Memory (ROM) that houses SW-Att code and \mathcal{K} used in the HMAC computation. Because \mathcal{K} and SW-Att code are stored in ROM, we have guaranteed immutability, i.e., **P5**. *VRASED* also reserves a fixed part of the memory address space for SW-Att stack. This amounts to $\approx 3\%$ of the address space,

as discussed in Section 6². Access control to dedicated memory regions, as well as SW-Att atomic execution are enforced by HW-Mod. The memory backbone is extended to support multiplexing of the new memory regions. HW-Mod takes 7 input signals from the MCU core: PC , irq , D_{addr} , R_{en} , W_{en} , DMA_{addr} and DMA_{en} . These inputs are used to determine a one-bit *reset* signal output, that, when set to 1, resets the MCU core immediately, i.e., before execution of the next instruction. The *reset* output is triggered when HW-Mod detects any violation of security properties³.

3.4 Verification Approach

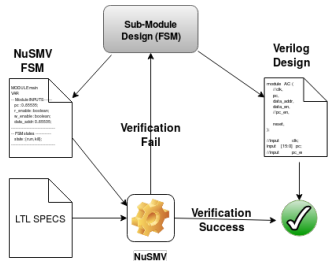

Figure 4: VRASED’s submodule verification

An overview of HW-Mod verification is shown in Figures 4 and 5. We start by formalizing RA sub-properties discussed in this section using Linear Temporal Logic (LTL) to define invariants that must hold throughout the entire system execution. HW-Mod is implemented as a composition of sub-modules written in the Verilog hardware description language (HDL). Each sub-module implements the hardware responsible for ensuring a given subset of the LTL specifications. Each sub-module is described as an FSM in: (1) Verilog at Register Transfer Level (RTL); and (2) the Model-Checking language SMV [17]. We then use the NuSMV model checker to verify that the FSM complies with the LTL specifications. If verification fails, the sub-module is re-designed.

Once each sub-module is verified, they are combined into a single Verilog design. The composition is converted to SMV using the automatic translation tool Verilog2SMV [27]. The resulting SMV is simultaneously verified against all LTL specifications to prove that the final Verilog design for HW-Mod complies with all secure RA properties.

We clarify that the individual SMV sub-modules’ design and verification steps are not strictly required in the verification pipeline. This is because verifying SMV that is automatically translated from the composition of HW-Mod would suffice. Nevertheless, we design FSMs in SMV first so as to facilitate

²A separate region in RAM is not strictly required. Alternatives and trade-offs are discussed in Section 5

³Resets due to VRASED violations do not give malware advantages as malware can always trigger resets on the unmodified MCU by inducing software faults.

sub-modules’ development and reasoning with an early additional check before going into their actual implementation and composition in Verilog.

Remark: Automatic conversion of the composition of HW-Mod from Verilog to SMV rules out the possibility of human mistakes in representing Verilog FSMs as SMV.

For the SW-Att part of VRASED, we use the HMAC-SHA-256 from the HACL* library [51] to compute an authenticated integrity check of attested memory and $Chal$ received from $\mathcal{V}rf$. This function is formally verified with respect to memory safety, functional correctness, and cryptographic security. However, key secrecy properties (such as clean-up of memory tainted by the key) are not formally verified in HACL* and thus must be ensured by HW-Mod.

As the last step, we prove that the conjunction of the LTL properties guaranteed by HW-Mod and SW-Att implies soundness and security of the RA architecture. These are formally specified in Section 4.2.

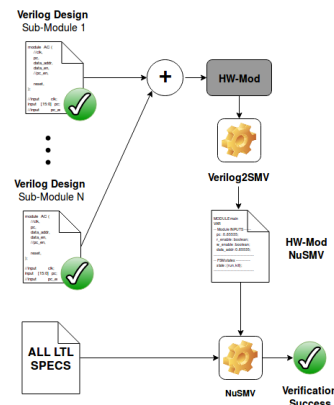

Figure 5: Verification framework for the composition of sub-modules (HW-Mod).

4 Verifying VRASED

In this section we formalize RA sub-properties. For each sub-property, we represent it as a set of LTL specifications and construct an FSM that is verified to conform to such specifications. Finally, the conjunction of these FSMs is implemented in Verilog HDL and translated to SMV using Verilog2SMV. The generated SMV description for the conjunction is proved to simultaneously hold for all specifications. We also define end-to-end soundness and security goals which are derived from the verified sub-properties (See Appendix A for the proof).

4.1 Notation

To facilitate generic LTL specifications that represent VRASED’s architecture (see Figure 3) we use the following:

- AR_{min} and AR_{max} : first and last physical addresses of the memory region to be attested;
- CR_{min} and CR_{max} : physical addresses of first and last instructions of SW-Att in ROM;
- K_{min} and K_{max} : first and last physical addresses of the ROM region where \mathcal{K} is stored;
- XS_{min} and XS_{max} : first and last physical addresses of the RAM region reserved for SW-Att computation;
- MAC_{addr} : fixed address that stores the result of SW-Att computation (HMAC);
- MAC_{size} : size of HMAC result;

Table 1 uses the above definitions and summarizes the notation used in our LTL specifications throughout the rest of this paper.

To simplify specification of defined security properties, we use $[A, B]$ to denote a contiguous memory region between A and B . Therefore, the following equivalence holds:

$$C \in [A, B] \Leftrightarrow (C \leq B \wedge C \geq A) \quad (1)$$

For example, expression $PC \in CR$ holds when the current value of PC signal is within CR_{min} and CR_{max} , meaning that the MCU is currently executing an instruction in CR , i.e, a SW-Att instruction. This is because in the notation introduced above: $PC \in CR \Leftrightarrow PC \in [CR_{min}, CR_{max}] \Leftrightarrow (PC \leq CR_{max} \wedge PC \geq CR_{min})$.

FSM Representation. As discussed in Section 3, HW-Mod sub-modules are represented as FSMs that are verified to hold for LTL specifications. These FSMs correspond to the Verilog hardware design of HW-Mod sub-modules. The FSMs are implemented as Mealy machines, where output changes at any time as a function of both the current state and current input values⁴. Each FSM has as inputs a subset of the following signals and wires: $\{PC, irq, R_{en}, W_{en}, D_{addr}, DMA_{en}, DMA_{addr}\}$.

Each FSM has only one output, *reset*, that indicates whether any security property was violated. For the sake of presentation, we do not explicitly represent the value of the *reset* output for each state. Instead, we define the following implicit representation:

1. *reset* output is 1 whenever an FSM transitions to the *Reset* state;
2. *reset* output remains 1 until a transition leaving the *Reset* state is triggered;
3. *reset* output is 0 in all other states.

4.2 Formalizing RA Soundness and Security

We now define the notions of soundness and security. Intuitively, RA soundness corresponds to computing an integrity ensuring function over memory at time t . Our integrity ensuring function is an HMAC computed on memory AR with a one-time key derived from \mathcal{K} and $Chal$. Since SW-Att computation is not instantaneous, RA soundness must ensure that

⁴This is in contrast with Moore machines where the output is defined solely based on the current state.

Table 1: Notation summary

Notation	Description
PC	Current Program Counter value
R_{en}	Signal that indicates if the MCU is reading from memory (1-bit)
W_{en}	Signal that indicates if the MCU is writing to memory (1-bit)
D_{addr}	Address for an MCU memory access
DMA_{en}	Signal that indicates if DMA is currently enabled (1-bit)
DMA_{addr}	Memory address being accessed by DMA, if any
CR	(Code ROM) Memory region where SW-Att is stored: $CR = [CR_{min}, CR_{max}]$
KR	(\mathcal{K} ROM) Memory region where \mathcal{K} is stored: $KR = [K_{min}, K_{max}]$
XS	(eXclusive Stack) secure RAM region reserved for SW-Att computations: $XS = [XS_{min}, XS_{max}]$
MR	(MAC RAM) RAM region in which SW-Att computation result is written: $MR = [MAC_{addr}, MAC_{addr} + MAC_{size} - 1]$. The same region is also used to pass the attestation challenge as input to SW-Att
AR	(Attested Region) Memory region to be attested. Can be fixed/predefined or specified in an authenticated request from $\mathcal{V}rf$: $AR = [AR_{min}, AR_{max}]$
<i>reset</i>	A 1-bit signal that reboots the MCU when set to logic 1
$A1, A2, \dots, A7$	Verification axioms (outlined in section 3.1)
$P1, P2, \dots, P7$	Properties required for secure RA (outlined in section 3.2)

attested memory does not change during computation of the HMAC. This is the notion of temporal consistency in remote attestation [14]. In other words, the result of SW-Att call must reflect the entire state of the attested memory at the time when SW-Att is called. This notion is captured in LTL by Definition 1.

Definition 1. End-to-end definition for soundness of RA computation

$$G : \{ PC = CR_{min} \wedge AR = M \wedge MR = Chal \wedge [(-reset) U (PC = CR_{max})] \rightarrow \\ F : [PC = CR_{max} \wedge MR = HMAC(KDF(\mathcal{K}, Chal), M)] \}$$

where M is any AR value and KDF is a secure key derivation function.

In Definition 1, $PC = CR_{min}$ captures the time when SW-Att is called (execution of its first instruction). M and $Chal$ are the values of AR and MR . From this pre-condition, Definition 1 asserts that there is a time in the future when SW-Att computation finishes and, at that time, MR stores the result of $HMAC(KDF(\mathcal{K}, Chal), M)$. Note that, to satisfy Definition 1, $Chal$ and M in the resulting HMAC must correspond to the values in AR and MR , respectively, when SW-Att was called.

RA security is defined using the security game in Figure 6. It models an adversary \mathcal{A} (that is a probabilistic polynomial time, ppt, machine) that has full control of the software state of $\mathcal{P}rv$ (as the one described in Section 3.1). It can modify AR at will and call SW-Att a polynomial number of times in the security parameter (\mathcal{K} and $Chal$ bit-lengths). However, \mathcal{A} can not modify SW-Att code, which is stored in immutable memory. The game assumes that \mathcal{A} does not have direct access to \mathcal{K} , and only learns $Chal$ after it receives from $\mathcal{V}rf$ as part of the attestation request.

In the following sections, we define SW-Att functional correctness, LTL specifications 2-10 and formally verify that

Definition 2.**2.1 RA Security Game (RA-game):****Assumptions:**

- SW-Att is immutable, and \mathcal{K} is not known to \mathcal{A}
- l is the security parameter and $|\mathcal{K}| = |\text{Chal}| = |\text{MR}| = l$
- $\text{AR}(t)$ denotes the content in AR at time t
- \mathcal{A} can modify AR and MR at will; however, it loses its ability to modify them while SW-Att is running

RA-game:

1. **Setup:** \mathcal{A} is given oracle access to SW-Att.
2. **Challenge:** A random challenge $\text{Chal} \leftarrow \mathcal{S}\{0,1\}^l$ is generated and given to \mathcal{A} . \mathcal{A} continues to have oracle access to SW-Att.
3. **Response:** Eventually, \mathcal{A} responds with a pair (M, σ) , where σ is either forged by \mathcal{A} , or the result of calling SW-Att at some arbitrary time t .
4. \mathcal{A} wins if and only if $\sigma = \text{HMAC}(\text{KDF}(\mathcal{K}, \text{Chal}), M)$ and $M \neq \text{AR}(t)$.

2.2 RA Security Definition:

An RA protocol is considered secure if there is no ppt \mathcal{A} , polynomial in l , capable of winning the game defined in 2.1 with $\Pr[\mathcal{A}, \text{RA-game}] > \text{negl}(l)$

Figure 6: RA security definition for VRASED

VRASED’s design guarantees such LTL specifications. We define LTL specifications from the intuitive properties discussed in Section 3.2 and depicted in Figure 2. In Appendix A we prove that the conjunction of such properties achieves soundness (Definition 1) and security (Definition 2). For the security proof, we first show that VRASED guarantees that \mathcal{A} can never learn \mathcal{K} with more than negligible probability, thus satisfying the assumption in the security game. We then complete the proof of security via reduction, i.e., show that existence of an adversary that wins the game in Definition 2 implies the existence of an adversary that breaks the conjectured existential unforgeability of HMAC.

Remark: The rest of this section focuses on conveying the intuition behind the specification of LTL sub-properties. Therefore, our references to the MCU machine model are via Axioms **A1 - A7** which were described in high level. The interested reader can find an LTL machine model formalizing these notions in Appendix A, where we describe how such machine model is used construct computer proofs for Definitions 1 and 2.

4.3 VRASED SW-Att

To minimize required hardware features, hybrid RA approaches implement integrity ensuring functions (e.g., HMAC) in software. VRASED’s SW-Att implementation is built on top of HACL*’s HMAC implementation [51]. HACL* code is verified to be functionally correct, memory safe and secret independent. In addition, all memory is allocated on the stack making it predictable and deterministic.

SW-Att is simple, as depicted in Figure 7. It first derives a new unique context-specific key (key) from the master key (\mathcal{K}) by computing an HMAC-based key derivation function, HKDF [31], on Chal . This key derivation can be extended to incorporate attested memory boundaries if $\mathcal{V}rf$ specifies the range (see Appendix B). Finally, it calls HACL*’s HMAC, using key as the HMAC key. ATTEST_DATA_ADDR and

```

1 void HACL_HMAC_SHA2_256_hmac_entry() {
2     uint8_t key[64] = {0};
3     memcpy(key, (uint8_t*) KEY_ADDR, 64);
4     hacl_hmac((uint8_t*) key, (uint8_t*) key, (uint32_t) 64, (uint8_t*)
5             CHALL_ADDR, (uint32_t) 32);
6     hacl_hmac((uint8_t*) MAC_ADDR, (uint8_t*) key, (uint32_t) 32, (uint8_t*)
7             ATTEST_DATA_ADDR, (uint32_t) ATTEST_SIZE);
8     return();
9 }

```

Figure 7: SW-Att C Implementation

ATTEST_SIZE specify the memory range to be attested (AR in our notation). We emphasize that SW-Att resides in ROM, which guarantees **P5** under the assumption of no hardware attacks. Moreover, as discussed below, HW-Mod enforces that no other software running on $\mathcal{P}rv$ can access memory allocated by SW-Att code, e.g., $key[64]$ buffer allocated in line 2 of Figure 7.

HACL*’s verified HMAC is the core for guaranteeing **P4** (Functional Correctness) in VRASED’s design. SW-Att functional correctness means that, as long as the memory regions storing values used in SW-Att computation (CR , AR , and KR) do not change during its computation, the result of such computation is the correct HMAC. This guarantee can be formally expressed in LTL as in Definition 3. We note that since HACL*’s HMAC functional correctness is specified in F^* , instead of LTL, we manually convert its guarantees to the LTL expressed by Definition 3. By this definition, the value in MR does not need to remain the same, as it will eventually be overwritten by the result of SW-Att computation.

Definition 3. SW-Att functional correctness
$$G : \{ PC = CR_{min} \wedge MR = \text{Chal} \wedge [(\neg \text{reset} \wedge \neg \text{irq} \wedge CR = \text{SW-Att} \wedge KR = \mathcal{K} \wedge AR = M) \cup PC = CR_{max}] \rightarrow F : [PC = CR_{max} \wedge MR = \text{HMAC}(\text{KDF}(\mathcal{K}, \text{Chal}), M)] \}$$

where M is any arbitrary value for AR.

In addition, some HACL* properties, such as stack-based and deterministic memory allocation, are used in alternative designs of VRASED to ensure **P2** – see Section 5.

Functional correctness implies that the HMAC implementation conforms to its published standard specification on all possible inputs, retaining the specification’s cryptographic security. It also implies that HMAC executes in finite time. Secret independence ensures that there are no branches taken as a function of secrets, i.e., \mathcal{K} and key in Figure 7. This mitigates \mathcal{K} leakage via timing side-channel attacks. Memory safety guarantees that implemented code is type safe, meaning that it never reads from, or writes to: invalid memory locations, out-of-bounds memory, or unallocated memory. This is particularly important for preventing ROP attacks, as long as **P7** (controlled invocation) is also preserved⁵.

⁵Otherwise, even though the implementation is memory-safe and correct as a whole, chunks of a memory-safe code could still be used in ROP attacks.

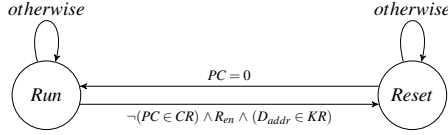

Figure 8: Verified FSM for Key AC

Having all memory allocated on the stack allows us to either: (1) confine SW-Att execution to a fixed size protected memory region inaccessible to regular software (including malware) running on $\mathcal{P}rv$; or (2) ensure that SW-Att stack is erased before the end of execution. Note that HACL* does not provide stack erasure, in order to improve performance. Therefore, **P2** does not follow from HACL* implementation. However, erasure before SW-Att terminates must be guaranteed. Recall that *VRASED* targets low-end MCUs that might run applications on bare-metal and thus can not rely on any OS features.

As discussed above, even though HACL* implementation guarantees **P4** and storage in ROM guarantees **P5**, these must be combined with **P6** and **P7** to provide safe execution. **P6** and **P7** – along with the key protection properties (**P1**, **P2**, and **P3**) – are ensured by HW-Mod, which are described next.

4.4 Key Access Control (HW-Mod)

If malware manages to read \mathcal{K} from ROM, it can reply to $\mathcal{V}rf$ with a forged result. HW-Mod access control (AC) sub-module enforces that \mathcal{K} can only be accessed by SW-Att (**P1**).

4.4.1 LTL Specification

The invariant for key access control (AC) is defined in LTL Specification (2). It stipulates that system must transition to the *Reset* state whenever code from outside CR tries to read from D_{addr} within the key space.

$$\mathbf{G} : \{ \neg(PC \in CR) \wedge Ren \wedge (D_{addr} \in KR) \rightarrow reset \} \quad (2)$$

4.4.2 Verified Model

Figure 8 shows the FSM implemented by the AC sub-module which is verified to hold for LTL Specification 2. This FSM has two states: *Run* and *Reset*. It outputs $reset = 1$ when the AC sub-module transitions to state *Reset*. This implies a hard-reset of the MCU. Once the reset process completes, the system leaves the *Reset* state.

4.5 Atomicity and Controlled Invocation (HW-Mod)

In addition to functional correctness, safe execution of attestation code requires immutability (**P5**), atomicity (**P6**), and

controlled invocation (**P7**). **P5** is achieved directly by placing SW-Att in ROM. Therefore, we only need to formalize invariants for the other two properties: atomicity and controlled execution.

4.5.1 LTL Specification

To guarantee atomic execution and controlled invocation, LTL Specifications (3), (4) and (5) must hold:

$$\mathbf{G} : \{ [\neg reset \wedge (PC \in CR) \wedge \neg(\mathbf{X}(PC) \in CR)] \rightarrow [PC = CR_{max} \vee \mathbf{X}(reset)] \} \quad (3)$$

$$\mathbf{G} : \{ [\neg reset \wedge \neg(PC \in CR) \wedge (\mathbf{X}(PC) \in CR)] \rightarrow [\mathbf{X}(PC) = CR_{min} \vee \mathbf{X}(reset)] \} \quad (4)$$

$$\mathbf{G} : \{ irq \wedge (PC \in CR) \rightarrow reset \} \quad (5)$$

LTL Specification (3) enforces that the only way for SW-Att execution to terminate is through its last instruction: $PC = CR_{max}$. This is specified by checking current and next PC values using LTL \mathbf{neXt} operator. In particular, if current PC value is within SW-Att region, and next PC value is out of SW-Att region, then either current PC value is the address of the last instruction in SW-Att (CR_{max}), or *reset* is triggered in the next cycle. Also, LTL Specification (4) enforces that the only way for PC to enter SW-Att region is through the very first instruction: CR_{min} . Together, these two invariants imply **P7**: it is impossible to jump into the middle of SW-Att, or to leave SW-Att before reaching the last instruction.

P6 is satisfied through LTL Specification (5). Atomicity could be violated by interrupts. However, LTL Specification (5) prevents an interrupt to happen while SW-Att is executing. Therefore, if interrupts are not disabled by software running on $\mathcal{P}rv$ before calling SW-Att, any interrupt that might violate SW-Att atomicity will cause an MCU *reset*.

4.5.2 Verified Model

Figure 9 presents a verified model for atomicity and controlled invocation enforcement. The FSM has five states. Two basic states *notCR* and *midCR* represent moments when PC points to an address: (1) outside CR , and (2) within CR , respectively, not including the first and last instructions of SW-Att. Another two: *fstCR* and *lstCR* represent states when PC points to the first and last instructions of SW-Att, respectively. Note that the only possible path from *notCR* to *midCR* is through *fstCR*. Similarly, the only path from *midCR* to *notCR* is through *lstCR*. The FSM transitions to the *Reset* state whenever: (1) any sequence of values for PC does not obey the aforementioned conditions; or (2) *irq* is logical 1 while executing SW-Att.

4.6 Key Confidentiality (HW-Mod)

To guarantee secrecy of \mathcal{K} and thus satisfy **P2**, *VRASED* must enforce the following:

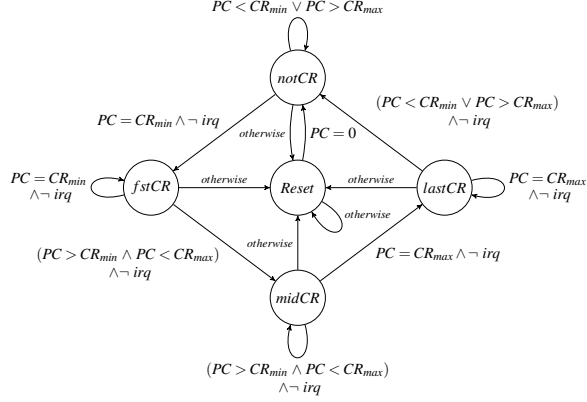

Figure 9: Verified FSM for atomicity and controlled invocation.

1. No leaks after attestation: any registers and memory accessible to applications must be erased at the end of each attestation instance, i.e., before application execution resumes.
2. No leaks on reset: since a reset can be triggered during attestation execution, any registers and memory accessible to regular applications must be erased upon reset.

Per Axiom **A4**, all registers are zeroed out upon reset and at boot time. Therefore, the only time when register clean-up is necessary is at the end of SW-Att. Such clean-up is guaranteed by the Callee-Saves-Register convention: Axiom **A6**.

Nonetheless, the leakage problem remains because of RAM allocated by SW-Att. Thus, we must guarantee that \mathcal{K} is not leaked through "dead" memory, which could be accessed by application (possibly, malware) after SW-Att terminates. A simple and effective way of addressing this issue is by reserving a separate secure stack in RAM that is only accessible (i.e., readable and writable) by attestation code. All memory allocations by SW-Att must be done on this stack, and access control to the stack must be enforced by HW-Mod. As discussed in Section 6, the size of this stack is constant – 2.3KBytes. This corresponds to $\approx 3\%$ of MSP430 16-bit address space. We discuss VRASED variants that do not require a reserved stack and trade-offs between them in Section 5.

4.6.1 LTL Specification

Recall that XS denote a contiguous secure memory region reserved for exclusive access by SW-Att. LTL Specification for the secure stack sub-module is as follows:

$$\mathbf{G} : \{ \neg(PC \in CR) \wedge (Ren \vee W_en) \wedge (D_{addr} \in XS) \rightarrow reset \} \quad (6)$$

We also want to prevent attestation code from writing into application memory. Therefore, it is only allowed to write to the designated fixed region for the HMAC result (MR).

$$\mathbf{G} : \{ (PC \in CR) \wedge (W_en) \wedge \neg(D_{addr} \in XS) \wedge \neg(D_{addr} \in MR) \rightarrow reset \} \quad (7)$$

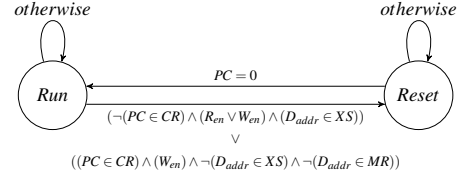

Figure 10: Verified FSM for Key Confidentiality

In summary, invariants (6) and (7) enforce that only attestation code can read from/write to the secure reserved stack and that attestation code can only write to regular memory within the space reserved for the HMAC result. If any of these conditions is violated, the system resets.

4.6.2 Verified Model

Figure 10 shows the FSM verified to comply with invariants (6) and (7).

4.7 DMA Support

So far, we presented a formalization of HW-Mod sub-modules under the assumption that DMA is either not present or disabled on $\mathcal{P}rv$. However, when present, a DMA controller can access arbitrary memory regions. Such memory access is performed concurrently in the memory backbone and without MCU intervention, while the MCU executes regular instructions.

DMA data transfer is performed using dedicated memory buses, e.g., DMA_{en} and DMA_{addr} . Hence, regular memory access control (based on monitoring D_{addr}) does not apply to memory access by DMA controller. Thus, if DMA controller is compromised, it may lead to violation of **P1** and **P2** by directly reading \mathcal{K} and values in the attestation stack, respectively. In addition, it can assist $\mathcal{P}rv$ -resident malware to escape detection by either copying it out of the measurement range or deleting it, which results in a violation of **P6**.

4.7.1 LTL Specification

We introduce three additional LTL Specifications to protect against aforementioned attacks. First, we enforce that DMA cannot access \mathcal{K} .

$$\mathbf{G} : \{ DMA_{en} \wedge (DMA_{addr} \in KR) \rightarrow reset \} \quad (8)$$

Similarly, LTL Specification for preventing DMA access to the attestation stack is defined as:

$$\mathbf{G} : \{ DMA_{en} \wedge (DMA_{addr} \in XS) \rightarrow reset \} \quad (9)$$

Finally, invariant (10) specifies that DMA must be always disabled while PC is in SW-Att region. This prevents DMA controller from helping malware escape during attestation.

$$\mathbf{G} : \{ (PC \in CR) \wedge DMA_{en} \rightarrow reset \} \quad (10)$$

4.7.2 Verified Model

Figure 11 shows the FSM verified to comply with invariants (8) to (10).

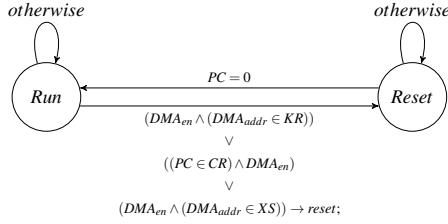

Figure 11: Verified FSM for DMA protection

4.8 HW-Mod Composition

Thus far, we designed and verified individual HW-Mod sub-modules according to the methodology in Section 3.4 and illustrated in Figure 4. We now follow the workflow of Figure 5 to combine the sub-modules into a single Verilog module. Since each sub-module individually guarantees a subset of properties **P1–P7**, the composition is simple: the system must reset whenever any sub-module reset is triggered. This is implemented by a logical OR of sub-modules reset signals. The composition is shown in Figure 12.

To verify that all LTL specifications still hold for the composition, we use Verilog2SMV [27] to translate HW-Mod to SMV and verify SMV for all of these specifications simultaneously.

4.9 Secure Reset (HW-Mod)

Finally, we define an LTL Specification for secure reset (**P3**). According to Axiom **A4**, all registers (including PC) are set to 0 on reset. However, the reset routine implemented by the MCU might take several clock cycles. Ensuring that $reset = 1$ until the point when registers are wiped is important in order to guarantee that \mathcal{K} is not leaked through registers after a reset.

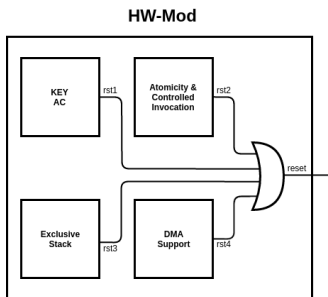

Figure 12: HW-Mod composition from sub-modules

That is because some part of \mathcal{K} might remain in some of the registers if a reset happens during SW-Att execution.

4.9.1 LTL Specification

To guarantee that the reset signal is active for long enough so that the MCU reset finishes and all registers are cleaned-up, it must hold that:

$$\mathbf{G} : \{reset \rightarrow [(reset \ \mathbf{U} \ PC = 0) \ \vee \ \mathbf{G}(reset)]\} \quad (11)$$

Invariant (11) states: when reset signal is triggered, it can only be released after $PC = 0$. Transition from *Reset* state in all sub-modules presented in this section already takes this invariant into account. Thus, HW-Mod composition also verifies LTL Specification (11).

5 Alternative Designs

We now discuss alternative designs for *VRASED* that guarantee verified properties without requiring a separate secure stack region for SW-Att operations. Recall that HW-Mod enforces that only SW-Att can access this stack. Since memory usage in HACL* HMAC is deterministic, the size of the separate stack can be pre-determined – 2,332bytes. Even though resulting in overall (HW and SW) design simplicity, dedicating 3% of addressable memory to secure RA might not be desirable. Therefore, we consider several alternatives. In Section 6 the costs involved with these alternatives are quantified and compared to the standard design of *VRASED*.

5.1 Erasure on SW-Att

The most intuitive alternative to a reserved secure stack (which prevents accidental key leakage by SW-Att) is to encode corresponding properties into the HACL* implementation and proof. Specifically, it would require extending the HACL* implementation to zero out all allocated memory before every function return. In addition, to retain verification of **P2** (in Section 3.2) and ensure no leakage, HACL*-verified properties must be extended to incorporate memory erasure. This is not yet supported in HACL* and doing so would incur a slight performance overhead. However, the trade-off between performance and RAM savings might be worthwhile.

At the same time, we note that, even with verified erasure as a part of SW-Att, **P2** is still not guaranteed if the MCU does not guarantee erasure of the entire RAM upon boot. This is necessary in order to consider the case when *Prv* re-boots in the middle of SW-Att execution. Without a reserved stack, \mathcal{K} might persist in RAM. Since the memory range for SW-Att execution is not fixed, hardware support is required to bootstrap secure RAM erasure before starting any software execution. In fact, such support is necessary for all approaches without a separate secure stack.

5.2 Compiler-Based Clean-Up

While stack erasure in HACL* would integrate nicely with the overall proof of SW-Att, the assurance would be at the language abstraction level, and not necessarily at the machine level. The latter would require additional assumptions about the compilation tool chain. We could also consider performing stack erasure directly in the compiler. In fact, a recent proposal to do exactly that was made in zerostack [44], an extension to Clang/LLVM. In case of VRASED, this feature could be used on unmodified HACL* (at compilation time), to add instructions to erase the stack before the return of each function enabling P2, assuming the existence of a verified RAM erasure routine upon boot. We emphasize that this approach may increase the compiler’s trusted code base. Ideally, it should be implemented and formally verified as part of a verified compiler suite, such as CompCert [32].

5.3 Double-HMAC Call

Finally, complete stack erasure could also be achieved directly using currently verified HACL* properties, without any further modifications. This approach involves invoking HACL* HMAC function a second time, after the computation of the actual HMAC. The second "dummy" call would use the same input data, however, instead of using \mathcal{K} , an independent constant, such as $\{0\}^{512}$, would be used as the HMAC key.

Recall that HACL* is verified to only allocate memory on the stack in a deterministic manner. Also, due to HACL*’s verified properties that mitigate side-channels, software flow does not change based on the secret key. Therefore, this deterministic allocation implies that, for inputs of the same size, any variable allocated by the first "real" HMAC call (tainted by \mathcal{K}), would be overwritten by the corresponding variable in the second "dummy" call. Note that the same guarantee discussed in Section 5.1 is provided here and secure RAM erasure at boot would still be needed for the same reasons. Admittedly, this double-HMAC approach would consume twice as many CPU cycles. Still, it might be a worthwhile trade-off, especially, if there is memory shortage and lack of previously discussed HACL* or compiler extension.

6 Evaluation

We now discuss implementation details and evaluate VRASED’s overhead and performance. Section 6.2 reports on verification complexity. Section 6.3 discusses performance in terms of time and space complexity as well as its hardware overhead. We also provide a comparison between VRASED and other RA architectures targeting low-end devices, namely

⁶As mentioned in Section 5.2, there is no formally verified msp430 compiler capable of performing stack erasure. Thus, we estimate overhead of this approach by manually inserting code required for erasing the stack in SW-Att.

SANCUS [37] and SMART [20], in Section 6.4.

6.1 Implementation

As mentioned earlier, we use OpenMSP430 [21] as an open core implementation of the MSP430 architecture. OpenMSP430 is written in the Verilog hardware description language (HDL) and can execute software generated by any MSP430 toolchain with near cycle accuracy. We modified the standard OpenMSP430 to implement the hardware architecture presented in Section 3.3, as shown in Figure 3. This includes adding ROM to store \mathcal{K} and SW-Att, adding HW-Mod, and adapting the memory backbone accordingly. We use Xilinx Vivado [49] – a popular logic synthesis tool – to synthesize an RTL description of HW-Mod into hardware in FPGA. FPGA synthesized hardware consists of a number of logic cells. Each consists of Look-Up Tables (LUTs) and registers; LUTs are used to implement combinatorial boolean logic while registers are used for sequential logic elements, i.e., FSM states and data storage. We compiled SW-Att using the native msp430-gcc [45] and used Linker scripts to generate software images compatible with the memory layout of Figure 3. Finally, we evaluated VRASED on the FPGA platform targeting Artix-7 [50] class of devices.

6.2 Verification Results

As discussed in Section 3.2, VRASED’s verification consists of properties P1–P7. P5 is achieved directly by executing SW-Att from ROM. Meanwhile, HACL* HMAC verification implies P4. All other properties are automatically verified using NuSMV model checker. Table 3 shows the verification results of VRASED’s HW-Mod composition as well as results for individual sub-modules. It shows that VRASED successfully achieves all the required security properties. These results also demonstrate feasibility of our verification approach, since the verification process – running on a commodity desktop computer – consumes only small amount of memory and time: < 14MB and 0.3sec, respectively, for all properties.

6.3 Performance and Hardware Cost

We now report on VRASED’s performance considering the standard design (described in Section 4) and alternatives discussed in Section 5. We evaluate the hardware footprint, memory (ROM and secure RAM), and run-time. Table 2 summarizes the results.

Hardware Footprint. The secure stack approach adds around 434 lines of code in Verilog HDL. This corresponds to around 20% of the code in the original OpenMSP430 core. In terms of synthesized hardware, it requires 122 (6.6%) and 19 (5.4%) additional LUTs and registers respectively. Overall, VRASED contains 193 logic cells more than the unmodified OpenMSP430 core, corresponding to a 6.3% increase.

Table 2: Evaluation of cost, overhead, and performance of RA

Method	RAM Erasure Required Upon Boot?	FPGA Hardware			Verilog LoC	Memory (byte)		Time to attest 4KB	
		LUT	Reg	Cell		ROM	Sec. RAM	CPU cycles	ms (at 8MHz)
Core (Baseline)	N/A	1842	684	3044	4034	0	0	N/A	N/A
Secure Stack (Section 4)	No	1964	721	3237	4621	4500	2332	3601216	450.15
Erasure on SW-Att (Section 5.1)	Yes	1954	717	3220	4516	4522	0	3613283	451.66
Compiler-based Clean-up (Section 5.2) ⁶	Yes	1954	717	3220	4516	4522	0	3613283	451.66
Double-HMAC Call (Section 5.3)	Yes	1954	717	3220	4516	4570	0	7201605	900.20

Table 3: Verification results running on a desktop @ 3.40 GHz.

HW Submod.	LTL Spec.	Mem. (MB)	Time (s)	Verified
Key AC	2,11	7.5	.02	✓
Atomicity	3,4,5,11	8.5	.05	✓
Exclusive Stack	6,7,11	8.1	.03	✓
DMA Support	8-11	8.2	.04	✓
HW-Mod	2-11	13.6	.28	✓

Memory. *VRASED* requires ~ 4.5 KB of ROM; most of which (96%) is for storing HACLS* HMAC-SHA256 code. The secure stack approach has the smallest ROM size, as it does not need to perform a memory clean-up in software. However, this advantage is attained at the price of requiring 2.3KBytes of reserved RAM. This overhead corresponds to 3.5% of MSP430 16-bit address space.

Attestation Run-time. Attestation run-time is dominated by the time it takes to compute the HMAC of *Prv*'s memory. The secure stack, erasure on SW-Att and compiler-based clean-up approaches take roughly .45s to attest 4KB of RAM on an MSP430 device with a clock frequency at 8MHz. Whereas, the double MAC approach requires invoking the HMAC function twice, leading its run-time to be roughly two times slower.

Discussion. We consider *VRASED*'s overhead to be affordable. The additional hardware, including registers, logic gates and exclusive memory, resulted in only a 3-6% increase. The number of cycles required by SW-Att exhibits a linear increase with the size of attested memory. As MSP430 typically runs at 8-25MHz, attestation of the entire RAM on a typical MSP430 can be computed in less than a second. *VRASED*'s RA is relatively cheap to the *Prv*. As a point of comparison we can consider a common cryptographic primitive such as the Curve25519 Elliptic-Curve Diffie-Hellman (ECDH) key exchange. A single execution of an optimized version of such protocol on MSP430 has been reported to take ≈ 9 million cycles [23]. As Table 2 shows, attestation of 4KBytes (typical size of RAM in some MSP430 models) can be computed three times faster.

6.4 Comparison with Other Low-End RA Architectures

We here compare *VRASED*'s overhead with two widely known RA architectures targeting low-end embedded systems: SMART [20] and SANCUS [37]. We emphasize, however, that both SMART and SANCUS were designed in an ad hoc manner. Thus, they can not be formally verified and do not provide any guarantees offered by *VRASED*'s verified architecture.

Table 4: Qualitative comparison between RA architectures targeting low-end devices

	<i>VRASED</i>	SMART	SANCUS
Design Type	Hybrid (HW/SW)	Hybrid (HW/SW)	Pure HW
RA function	HMAC-SHA256	HMAC-SHA1	SPONGNET-128/128/8
ROM for RA code	Yes	Yes	No
DMA Support	Yes	No	No
Formally Verified	Yes	No	No

Nevertheless, it is considered important to contrast *VRASED*'s cost with such architectures to demonstrate its affordability.

Table 4 presents a comparison between features offered and required by aforementioned architectures. SANCUS is, to the best of our knowledge, the cheapest pure HW-based architecture, while SMART is a minimal HW/SW RA co-design. Since SANCUS's RA routine is implemented entirely in HW, it does not require ROM to store the SW implementation of the integrity ensuring function. *VRASED* implements a MAC with digest sizes of 256-bits. SMART and SANCUS, on the other hand, use SHA1-based MAC and SPONGNET-128/128/8 [7], respectively. Such MACs do not offer strong collision resistance due to the small digest sizes (and known collisions). Of the three architectures, *VRASED* is the only one secure in the presence of DMA and the only one to be rigorously specified and formally verified.

Figure 13 presents a quantitative comparison between the RA architectures. It considers additional overhead in relation to the latest version of the unmodified OpenMSP430 (Available at [21]). Compared to *VRASED*, SANCUS requires $12\times$ more Look-Up Tables, $22\times$ more registers, and its (unverified) TCB is 2.5 times larger in lines of Verilog code. This comparison demonstrates the cost of relying on a HW-only approach even when designed for minimality. SMART's overhead is slightly smaller than that of *VRASED* due to lack of DMA support. In terms of attestation execution time, SMART is the slowest, requiring 9.2M clock cycles to attest 4KB of memory. SANCUS achieves the fastest attestation time (1.3M cycles) due to the HW implementation of SPONGNET-128/128/8. *VRASED* sits in between the two with a total attestation time of 3.6M cycles.

7 Related Work

We are unaware of any previous work that yielded a formally verified RA design (RA architectures are overviewed in Section 2.1). To the best of our knowledge, *VRASED* is the first verification of a security service implemented as HW/SW co-

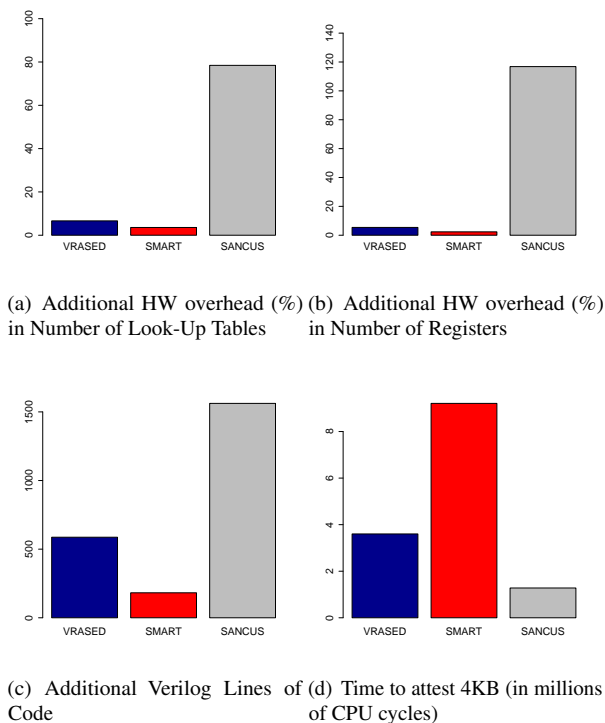

Figure 13: Comparison between RA architectures targeting low-end devices

design. Nevertheless, formal verification has been widely used as the *de facto* means to guarantee that a system is free of implementation errors and bugs. In recent years, several efforts focused on verifying security-critical systems.

In terms of cryptographic primitives, Hawblitzel et al. [22] verified new implementations of SHA, HMAC, and RSA. Beringer et al. [4] verified the Open-SSL SHA-256 implementation. Bond et al. [8] verified an assembly implementation of SHA-256, Poly1305, AES and ECDSA. More recently, Zinzindohoué, et al. [51] developed HACL*, a verified cryptographic library containing the entire cryptographic API of NaCl [5]. As discussed earlier, HACL*’s verified HMAC forms the core of VRASED’s software component.

Larger security-critical systems have also been successfully verified. For example, Bhargavan [6] implemented the TLS protocol with verified cryptographic security. CompCert [32] is a C compiler that is formally verified to preserve C code semantics in generated assembly code. Klein et al. [28] designed and proved functional correctness of seL4 – the first verified general-purpose microkernel. More recently, Tuncay et al. verified a design for Android OS App permissions model [47].

The importance of verifying RA has been recently acknowledged by Lugou et al. [35], which discussed methodologies for specifically verifying HW/SW RA co-designs. A follow-on result proposed the SMASH-UP tool [36]. By modeling a hard-

ware abstraction, SMASH-UP allows automatic conversion of assembly instructions to the effects on hardware representation. Similarly, Cabodi et al. [11, 12] discussed the first steps towards formalizing hybrid RA properties. However, none of these results yielded a fully verified (and publicly available) RA architecture, such as VRASED.

8 Conclusion

This paper presents VRASED – the first formally verified RA method that uses a verified cryptographic software implementation and combines it with a verified hardware design to guarantee correct implementation of RA security properties. VRASED is also the first verified security service implemented as a HW/SW co-design. VRASED was designed with simplicity and minimality in mind. It results in efficient computation and low hardware cost, realistic even for low-end embedded systems. VRASED’s practicality is demonstrated via publicly available implementation using the low-end MSP430 platform. The design and verification methodology presented in this paper can be extended to other MCU architectures. We believe that this work represents an important and timely advance in embedded systems security, especially, with the rise of heterogeneous ecosystems of (inter-)connected IoT devices.

The most natural direction for future work is to adapt VRASED to other MCU architectures. Such an effort could follow the same verification methodology presented in this paper. It would involve: (1) mapping MCUs specifications to a set of axioms (as we did for MSP430 in Section 3), and (2) adapting the proofs by modifying the LTL Specifications and hardware design (as in in Section 4) accordingly. A second direction is to extend VRASED’s capabilities to include and verify other trusted computing services such as secure updates, secure deletion, and remote code execution. It would also be interesting to verify and implement other RA designs with different requirements and trade-offs, such as software- and hardware-based techniques. In the same vein, one promising direction would be to verify HYDRA RA architecture [19], which builds on top of the formally verified seL4 [28] microkernel. Finally, the optimization of VRASED’s HMAC, with respect to computation and memory allocation, while retaining its verified properties, is an interesting open problem.

References

- [1] VRASED source code. <https://github.com/sprout-uci/vrased>, 2019.
- [2] M. Antonakakis, T. April, M. Bailey, M. Bernhard, E. Bursztein, J. Cochran, Z. Durumeric, J. A. Halderman, L. Invernizzi, M. Kallitsis, et al. Understanding the mirai botnet. In *USENIX Security Symposium*, 2017.
- [3] Arm Ltd. Arm TrustZone, 2018.
- [4] L. Beringer, A. Petcher, Q. Y. Katherine, and A. W. Appel. Verified correctness and security of OpenSSL HMAC. In *USENIX*, 2015.

- [5] D. J. Bernstein, T. Lange, and P. Schwabe. The security impact of a new cryptographic library. In *International Conference on Cryptology and Information Security in Latin America*, 2012.
- [6] K. Bhargavan, C. Fournet, M. Kohlweiss, A. Pironti, and P.-Y. Strub. Implementing TLS with verified cryptographic security. In *SP*, 2013.
- [7] A. Bogdanov, M. Knezevic, G. Leander, D. Toz, K. Varici, and I. Verbauwhede. Spongint: The design space of lightweight cryptographic hashing. *IEEE Transactions on Computers*, 62, 2013.
- [8] B. Bond, C. Hawblitzel, M. Kapritsos, K. R. M. Leino, J. R. Lorch, B. Parno, A. Rane, S. Setty, and L. Thompson. Vale: Verifying high-performance cryptographic assembly code. In *USENIX*, 2017.
- [9] F. Brasser, B. El Mahjoub, A.-R. Sadeghi, C. Wachsmann, and P. Koeberl. TyTAN: tiny trust anchor for tiny devices. In *DAC*. ACM.
- [10] F. Brasser, A.-R. Sadeghi, and G. Tsudik. Remote attestation for low-end embedded devices: the prover’s perspective. In *DAC*, 2016.
- [11] G. Cabodi, P. Camurati, S. F. Finocchiario, C. Loiacono, F. Savarese, and D. Vendramineto. Secure embedded architectures: Taint properties verification. In *DAS*, 2016.
- [12] G. Cabodi, P. Camurati, C. Loiacono, G. Pipitone, F. Savarese, and D. Vendramineto. Formal verification of embedded systems for remote attestation. *WSEAS Transactions on Computers*, 14:760–769, 2015.
- [13] X. Carpent, K. Eldefrawy, N. Rattanavipanon, A.-R. Sadeghi, and G. Tsudik. Reconciling remote attestation and safety-critical operation on simple iot devices. In *2018 55th ACM/ESDA/IEEE Design Automation Conference (DAC)*, pages 1–6. IEEE, 2018.
- [14] X. Carpent, K. Eldefrawy, N. Rattanavipanon, and G. Tsudik. Temporal consistency of integrity-ensuring computations and applications to embedded systems security. In *ASIACCS*, 2018.
- [15] X. Carpent, N. Rattanavipanon, and G. Tsudik. ERASMUS: Efficient remote attestation via self-measurement for unattended settings. In *Design, Automation and Test in Europe (DATE)*, 2018.
- [16] X. Carpent, N. Rattanavipanon, and G. Tsudik. Remote attestation of iot devices via SMARM: Shuffled measurements against roving malware. In *IEEE International Symposium on Hardware Oriented Security and Trust (HOST)*, 2018.
- [17] A. Cimatti, E. Clarke, E. Giunchiglia, F. Giunchiglia, M. Pistore, M. Roveri, R. Sebastiani, and A. Tacchella. NuSMV 2: An opensource tool for symbolic model checking. In *International Conference on Computer Aided Verification*, pages 359–364. Springer, 2002.
- [18] A. Duret-Lutz, A. Lewkowicz, A. Fauchille, T. Michaud, E. Renault, and L. Xu. Spot 2.0—a framework for ltl and ω -automata manipulation. In *International Symposium on Automated Technology for Verification and Analysis*, pages 122–129. Springer, 2016.
- [19] K. Eldefrawy, N. Rattanavipanon, and G. Tsudik. HYDRA: hybrid design for remote attestation (using a formally verified microkernel). In *WiseC*. ACM, 2017.
- [20] K. Eldefrawy, G. Tsudik, A. Francillon, and D. Perito. SMART: Secure and minimal architecture for (establishing dynamic) root of trust. In *NDSS*. Internet Society, 2012.
- [21] O. Girard. openMSP430, 2009.
- [22] C. Hawblitzel, J. Howell, J. R. Lorch, A. Narayan, B. Parno, D. Zhang, and B. Zill. Ironclad apps: End-to-end security via automated full-system verification. In *OSDI*, volume 14, pages 165–181, 2014.
- [23] G. Hinterwalder, A. Moradi, M. Hutter, P. Schwabe, and C. Paar. Full-size high-security ECC implementation on MSP430 microcontrollers. In *International Conference on Cryptology and Information Security in Latin America*, pages 31–47. Springer, 2014.
- [24] A. Ibrahim, A.-R. Sadeghi, and S. Zeitouni. SeED: secure non-interactive attestation for embedded devices. In *ACM Conference on Security and Privacy in Wireless and Mobile Networks (WiSec)*, 2017.
- [25] T. Instruments. Msp430 ultra-low-power sensing & measurement mcus. <http://www.ti.com/microcontrollers/msp430-ultra-low-power-mcus/overview.html>.
- [26] Intel. Intel Software Guard Extensions (Intel SGX).
- [27] A. Irfan, A. Cimatti, A. Griggio, M. Roveri, and R. Sebastiani. Verilog2SMV: A tool for word-level verification. In *Design, Automation & Test in Europe Conference & Exhibition (DATE)*, 2016, pages 1156–1159. IEEE, 2016.
- [28] G. Klein, K. Elphinstone, G. Heiser, J. Andronick, D. Cock, P. Derrin, D. Elkaduwe, K. Engelhardt, R. Kolanski, M. Norrish, T. Sewell, H. Tuch, and S. Winwood. seL4: Formal verification of an OS kernel. In *Proceedings of the ACM SIGOPS 22Nd Symposium on Operating Systems Principles, SOSP ’09*, pages 207–220, New York, NY, USA, 2009. ACM.
- [29] P. Koeberl, S. Schulz, A.-R. Sadeghi, and V. Varadharajan. TrustLite: A security architecture for tiny embedded devices. In *EuroSys*. ACM, 2014.
- [30] X. Kovah, C. Kallenberg, C. Weathers, A. Herzog, M. Albin, and J. Butterworth. New results for timing-based attestation. In *Proceedings of the IEEE Symposium on Research in Security and Privacy*. IEEE Computer Society Press, 2012.
- [31] H. Krawczyk and P. Eronen. HMAC-based extract-and-expand key derivation function (HKDF). Internet Request for Comment RFC 5869, Internet Engineering Task Force, May 2010.
- [32] X. Leroy. Formal verification of a realistic compiler. *Communications of the ACM*, 52(7):107–115, 2009.
- [33] Y. Li, Y. Cheng, V. Gligor, and A. Perrig. Establishing software-only root of trust on embedded systems: Facts and fiction. In *Security Protocols—22nd International Workshop*, 2015.
- [34] Y. Li, J. M. McCune, and A. Perrig. Viper: Verifying the integrity of peripherals’ firmware. In *CCS*. ACM, 2011.
- [35] F. Lugou, L. Apvrille, and A. Francillon. Toward a methodology for unified verification of hardware/software co-designs. *Journal of Cryptographic Engineering*, 2016.
- [36] F. Lugou, L. Apvrille, and A. Francillon. Smashup: a toolchain for unified verification of hardware/software co-designs. *Journal of Cryptographic Engineering*, 7(1):63–74, 2017.
- [37] J. Noorman, J. V. Bulck, J. T. Muhlberg, F. Piessens, P. Maene, B. Preneel, I. Verbauwhede, J. Gotzfried, T. Muller, and F. Freiling. Sancus 2.0: A low-cost security architecture for iot devices. *ACM Trans. Priv. Secur.*, 20(3):7:1–7:33, July 2017.
- [38] I. D. O. Nunes, G. Dessouky, A. Ibrahim, N. Rattanavipanon, A.-R. Sadeghi, and G. Tsudik. Towards systematic design of collective remote attestation protocols. In *ICDCS*, 2019.
- [39] D. Perito and G. Tsudik. Secure code update for embedded devices via proofs of secure erasure. In *ESORICS*, 2010.
- [40] J. Protzenko, J.-K. Zinzindohoue, A. Rastogi, T. Ramanandro, P. Wang, S. Zanella-Beguelin, A. Delignat-Lavaud, C. Hritu, K. Bhargavan, C. Fournet, et al. Verified low-level programming embedded in f. *Proceedings of the ACM on Programming Languages*, 2017.
- [41] S. Ravi, A. Raghunathan, and S. Chakradhar. Tamper resistance mechanisms for secure embedded systems. In *VLSI Design, 2004. Proceedings. 17th International Conference on*, pages 605–611. IEEE, 2004.
- [42] A. Seshadri, M. Luk, A. Perrig, L. van Doorn, and P. Khosla. Scuba: Secure code update by attestation in sensor networks. In *ACM workshop on Wireless security*, 2006.
- [43] A. Seshadri, M. Luk, E. Shi, A. Perrig, L. van Doorn, and P. Khosla. Pioneer: Verifying code integrity and enforcing untampered code execution on legacy systems. *ACM SIGOPS Operating Systems Review*, December 2005.

- [44] L. Simon, D. Chisnall, and R. Anderson. What you get is what you C: Controlling side effects in mainstream C compilers. In *Proceedings of the Third IEEE European Symposium on Security and Privacy (EuroSP)*, London, UK, Apr. 2018. ACM SIGOPS.
- [45] Texas Instruments. MSP430 GCC user’s guide, 2016.
- [46] Trusted Computing Group. Trusted platform module (tpm), 2017.
- [47] G. S. Tuncay, S. Demetriou, K. Ganju, and C. A. Gunter. Resolving the predicament of Android custom permissions. In *ISOC Network and Distributed Systems Security Symposium (NDSS)*, 2018.
- [48] J. Vijayan. Stuxnet renews power grid security concerns. <http://www.computerworld.com/article/2519574/security0/stuxnet-renews-power-grid-security-concerns.html>, june 2010.
- [49] Xilinx. Vivado design suite user guide, 2017.
- [50] Xilinx Inc. Artix-7 FPGA family, 2018.
- [51] J.-K. Zinzindhoué, K. Bhargavan, J. Protzenko, and B. Beurdouche. Hacl*: A verified modern cryptographic library. In *Proceedings of the 2017 ACM SIGSAC Conference on Computer and Communications Security*, pages 1789–1806. ACM, 2017.

APPENDIX

A RA Soundness and Security Proofs

A.1 Proof Strategy

We present the proofs for RA soundness (Definition 1) and RA security (Definition 2). Soundness is proved entirely via LTL equivalences. In the proof of security we first show, via LTL equivalences, that *VRASED* guarantees that adversary \mathcal{A} can never learn \mathcal{K} with more than negligible probability. We then prove security by showing a reduction from HMAC existential unforgeability to security. In other words, we show that existence of \mathcal{A} that breaks *VRASED* implies existence of HMAC- \mathcal{A} able to break conjectured existential unforgeability of HMAC. The full machine-checked proofs for the LTL equivalences (using Spot 2.0 [18] proof assistant) discussed in the remainder of this section are available in [1].

A.2 Machine Model

To prove that *VRASED*’s design satisfies end-to-end definitions of soundness and security for RA, we start by formally defining (in LTL) memory and execution models corresponding to the architecture introduced in Section 3.

Definition 4 (Memory model).

1. \mathcal{K} is stored in ROM $\leftrightarrow G : \{KR = \mathcal{K}\}$
2. SW-Att is stored in ROM $\leftrightarrow G : \{CR = SW\text{-Att}\}$
3. MR, CR, AR, KR , and XS are non-overlapping memory regions

The memory model in Definition 4 captures that KR and CR are ROM regions, and are thus immutable. Hence, the values

stored in those regions always correspond to \mathcal{K} and SW-Att code, respectively. Finally, the memory model states that MR, CR, AR, KR , and XS are disjoint regions in the memory layout, corresponding to the architecture in Figure 3.

Definition 5 (Execution model).

1. $Modify_Mem(i) \rightarrow (W_{en} \wedge D_{addr} = i) \vee (DMA_{en} \wedge DMA_{addr} = i)$
2. $Read_Mem(i) \rightarrow (R_{en} \wedge D_{addr} = i) \vee (DMA_{en} \wedge DMA_{addr} = i)$
3. $Interrupt \rightarrow irq$

Our execution model, in Definition 5, translates MSP430 behavior by capturing the effects on the processor signals when reading and writing from/to memory. We do not model the effects of instructions that only modify register values (e.g., ALU operations, such as *add* and *mul*) because they are not necessary in our proofs.

The execution model defines that a given memory address can be modified in two cases: by a CPU instruction or by DMA. In the first case, the W_{en} signal must be on and D_{addr} must contain the memory address being accessed. In the second case, DMA_{en} signal must be on and DMA_{addr} must contain the address being modified by DMA. The requirements for reading from a given address are similar, except that instead of W_{en} , R_{en} must be on. Finally, the execution model also captures the fact that an interrupt implies setting the *irq* signal to 1.

A.3 RA Soundness Proof

The proof follows from SW-Att functional correctness (expressed by Definition 3) and LTL specifications 3, 5, 7, and 10

Theorem 1. *VRASED is sound according to Definition 1.*

Proof.

$$Definition\ 3 \wedge LTL_3 \wedge LTL_5 \wedge LTL_7 \wedge LTL_{10} \rightarrow Theorem\ 1$$

□

The formal computer proof for Theorem 1 can be found in [1]. Due to space limitations, we only provide some intuition, by splitting the proof into two parts. First, SW-Att functional correctness (Definition 3) would imply Theorem 1 if AR, CR, KR never change and an interrupt does not happen during SW-Att computation. However, memory model Definitions 4.1 and 4.2 already guarantee that CR and KR never change. Also, LTL 5 states that an interrupt cannot happen during SW-Att computation, otherwise the device resets. Therefore, it remains for us to show that AR does not change during SW-Att computation. This is stated in Lemma 1.

In turn, Lemma 1 can be proved by:

$$LTL_3 \wedge LTL_7 \wedge LTL_{10} \rightarrow Lemma\ 1 \quad (12)$$

Lemma 1. *Temporal Consistency – Attested memory does not change during SW-Att computation*

$$\mathbf{G} : \{ \\ PC = CR_{min} \wedge AR = M \wedge \neg reset \ U (PC = CR_{max}) \rightarrow \\ (AR = M) \ U (PC = CR_{max}) \}$$

The reasoning for Equation 12 is as follows:

- LTL_3 prevents the CPU from stopping execution of SW-Att before its last instruction.
- LTL_7 guarantees that the only memory regions written by the CPU during SW-Att execution are XS and MR , which do not overlap with AR .
- LTL_{10} prevents DMA from writing to memory during SW-Att execution.

Therefore, there are no means for modifying AR during SW-Att execution, implying Lemma 1. As discussed above, it is easy to see that:

$$Lemma\ 1 \wedge LTL_5 \wedge Definition\ 3 \rightarrow Theorem\ 1 \quad (13)$$

A.4 RA Security Proof

Recall the definition of RA security in the game in Figure 6. The game makes two key assumptions:

1. SW-Att call results in a temporally consistent HMAC of AR using a key derived from \mathcal{K} and $Chal$. This is already proved by VRASED’s soundness.
2. \mathcal{A} never learns \mathcal{K} with more than negligible probability.

Lemma 2. *Key confidentiality – \mathcal{K} can not be accessed directly by untrusted software ($\neg(PC \in CR)$) and any memory written to by SW-Att can never be read by untrusted software.*

$$\mathbf{G} : \{ \\ \neg(PC \in CR) \wedge Read_Mem(i) \wedge i \in KR \rightarrow reset \wedge \\ (DMA_{en} \wedge DMA_{addr} = i \wedge i \in KR \rightarrow reset) \wedge \\ [\neg reset \wedge PC \in CR \wedge Modify_Mem(i) \wedge \neg(i \in MR) \rightarrow \\ \mathbf{G} : \{ \neg(PC \in CR) \wedge Read_Mem(i) \vee DMA_{en} \wedge DMA_{addr} = i \\ \rightarrow reset \}] \\ \}$$

By proving that VRASED’s design satisfies assumptions 1 and 2, we show that the capabilities of untrusted software (any DMA or CPU software other than SW-Att) on $\mathcal{P}rv$ are equivalent to the capabilities of \mathcal{A} in RA-game. Therefore, we still need to prove item 2 before we can use such game to prove VRASED’s security. The proof of \mathcal{A} ’s inability to learn \mathcal{K} with more than negligible probability is facilitated by A6 - *Callee-Saves-Register* convention stated in Section 3. A6 directly implies no leakage of information through registers on the return of SW-Att. This is because, before the return of a function,

registers must be restored to their state prior to the function call. Thus, untrusted software can only learn \mathcal{K} (or any function of \mathcal{K}) through memory. However, if untrusted software can never read memory written by SW-Att, it never learns anything about \mathcal{K} (not even through timing side channels since SW-Att is secret independent). Now, it suffices to prove that untrusted software can not access \mathcal{K} directly and that it can never read memory written by SW-Att. These conditions are stated in LTL in Lemma 2. We prove that VRASED satisfies Lemma 2 by writing a computer proof (available in [1]) for Equation 14. The reasoning for this proof is similar to that of RA soundness and omitted due to space constraints.

$$LTL_2 \wedge LTL_6 \wedge LTL_7 \wedge LTL_8 \wedge LTL_9 \wedge LTL_{10} \rightarrow Lemma\ 2 \quad (14)$$

We emphasize that Lemma 2 does not restrict reads and writes to MR , since this memory is used for inputting $Chal$ and receiving SW-Att result. Nonetheless, the already proved RA soundness and LTL 4 (which makes it impossible to execute fractions of SW-Att) guarantee that MR will not leak anything, because at the end of SW-Att computation it will always contain an HMAC result, which does not leak information about \mathcal{K} . After proving Lemma 2, the capabilities of untrusted software on $\mathcal{P}rv$ are equivalent to those of adversary \mathcal{A} in RA-game of Definition 2. Therefore, in order to prove VRASED’s security, it remains to show a reduction from HMAC security according to the game in Definition 2. VRASED’s security is stated and proved in Theorem 2.

Theorem 2. *VRASED is secure according to Definition 2 as long as HMAC is a secure MAC.*

Proof. A MAC is defined as tuple of algorithms $\{\mathbf{Gen}, \mathbf{Mac}, \mathbf{Vrf}\}$. For the reduction we construct a slightly modified $HMAC'$, which has the same \mathbf{Mac} and \mathbf{Vrf} algorithms as standard HMAC but $\mathbf{Gen} \leftarrow KDF(\mathcal{K}, Chal)$ where $Chal \leftarrow \mathcal{S}\{0, 1\}^l$. Since KDF function itself is implemented as a \mathbf{Mac} call, it is easy to see that the outputs of \mathbf{Gen} are indistinguishable from random. In other words, the security of this slightly modified construction follows from the security of HMAC itself. Assuming that there exists \mathcal{A} such that $Pr[\mathcal{A}, RA_{game}] > \text{negl}(l)$, we show that such adversary can be used to construct $HMAC\text{-}\mathcal{A}$ that breaks existential unforgeability of $HMAC'$ with probability $Pr[HMAC\text{-}\mathcal{A}, MAC\text{-}game] > \text{negl}(l)$. To that purpose $HMAC\text{-}\mathcal{A}$ behaves as follows:

1. $HMAC\text{-}\mathcal{A}$ selects msg to be the same $M \neq AR$ as in RA-game and asks \mathcal{A} to produce the same output used to win RA-game.
2. $HMAC\text{-}\mathcal{A}$ outputs the pair (msg, σ) as a response for the challenge in the standard existential unforgeability game, where σ is the output produced by \mathcal{A} in step 1.

By construction, (msg, σ) is a valid response to a challenge in the existential unforgeability MAC game considering $HMAC'$

as defined above. Therefore, HMAC- \mathcal{A} is able to win the existential unforgeability game with the same $> \text{negl}(l)$ probability that \mathcal{A} has of winning RA-game in Definition 2. \square

B Optional Verifier Authentication

```

1 void HACL_HMAC_SHA2_256_hmac_entry() {
2   uint8_t key[64] = {0};
3   uint8_t verification[32] = {0};
4   if (memcmp(CHALL_ADDR, CTR_ADDR, 32) > 0)
5   {
6     memcpy(key, KEY_ADDR, 64);
7
8     hacl_hmac((uint8_t*) verification, (uint8_t*) key,
9              (uint32_t) 64, *((uint8_t*)CHALL_ADDR),
10             (uint32_t) 32);
11
12     if (!memcmp(VRF_AUTH, verification, 32)
13         {
14       hacl_hmac((uint8_t*) key, (uint8_t*) key,
15                (uint32_t) 64, (uint8_t*) verification,
16                (uint32_t) 32);
17       hacl_hmac((uint8_t*) MAC_ADDR, (uint8_t*) key,
18                (uint32_t) 32, (uint8_t*) ATTEST_DATA_ADDR,
19                (uint32_t) ATTEST_SIZE);
20       memcpy(CTR_ADDR, CHALL_ADDR, 32);
21     }
22   }
23   return();
24 }

```

Figure 14: SW-Att Implementation with \mathcal{V}_{rf} authentication

Depending on the setting where \mathcal{P}_{rv} is deployed, authenticating the attestation request before executing SW-Att may be required. For example, if \mathcal{P}_{rv} is in a public network, the adversary may try to communicate with it. In particular, the adversary can impersonate \mathcal{V}_{rf} and send fake attestation requests to \mathcal{P}_{rv} , attempting to cause denial-of-service. This is particularly relevant if \mathcal{P}_{rv} is a safety-critical device. If \mathcal{P}_{rv} receives too many attestation requests, regular (and likely honest) software running on \mathcal{P}_{rv} would not execute because SW-Att would run all the time. Thus, we now discuss an optional part of VRASED’s design suitable for such settings. It supports and formally verifies authentication of \mathcal{V}_{rf} as part of SW-Att execution. Our implementation is based on the protocol in [10].

Figure 14 presents an implementation of SW-Att that includes \mathcal{V}_{rf} authentication. It also builds upon HACL* verified HMAC to authenticate \mathcal{V}_{rf} , in addition to computing the authenticated integrity check. In this case, \mathcal{V}_{rf} ’s request additionally contains an HMAC of the challenge computed using \mathcal{K} . Before calling SW-Att, software running on \mathcal{P}_{rv} is expected to store the received challenge on a fixed address $CHALL_ADDR$ and the corresponding received HMAC on VRF_AUTH . SW-Att discards the attestation request if (1) the received challenge is less than or equal to the latest challenge, or (2) HMAC of the received challenge is mismatched. After that, it derives a new unique key using HKDF [31] from \mathcal{K} and the received HMAC and uses it as the attestation key.

HW-Mod must also be slightly modified to ensure security of \mathcal{V}_{rf} ’s authentication. In particular, regular software must not be able to modify the memory region that stores \mathcal{P}_{rv} ’s counter. Notably, the counter requires persistent and writable storage,

```

1 void VRASED (uint8_t *challenge, uint8_t *response) {
2   //Copy input challenge to MAC_ADDR:
3   memcpy ((uint8_t*)MAC_ADDR, challenge, 32);
4
5   //Disable interrupts:
6   __dint();
7
8   //Save current value of r5 and r6:
9   __asm__ volatile("push r5" "\n\t");
10  __asm__ volatile("push r6" "\n\t");
11
12  //Write return address of HACL_HMAC_SHA2_256_hmac_entry
13  //to RAM:
14  __asm__ volatile("mov #0x000e, r6" "\n\t");
15  __asm__ volatile("mov #0x0300, r5" "\n\t");
16  __asm__ volatile("mov r0, @(r5)" "\n\t");
17  __asm__ volatile("add r6, @(r5)" "\n\t");
18
19  //Save the original value of the Stack Pointer (R1):
20  __asm__ volatile("mov r1, r5" "\n\t");
21
22  //Set the stack pointer to the base of the exclusive stack:
23  __asm__ volatile("mov #0x1000, r1" "\n\t");
24
25  //Call SW-Att:
26  HACL_HMAC_SHA2_256_hmac_entry();
27
28  //Copy retrieve the original stack pointer value:
29  __asm__ volatile("mov r5, r1" "\n\t");
30
31  //Restore original r5,r6 values:
32  __asm__ volatile("pop r6" "\n\t");
33  __asm__ volatile("pop r5" "\n\t");
34
35  //Enable interrupts:
36  __eint();
37
38  //Return the HMAC value to the application:
39  memcpy(response, (uint8_t*)MAC_ADDR, 32);
40 }

```

Figure 15: VRASED’s wrapper function.

because SW-Att needs to modify it at the end of each attestation execution. Therefore, CTR region resides on FLASH. We denote this region as:

$$\bullet CTR = [CTR_{min}, CTR_{max}];$$

LTl Specifications (15) and (16) must hold (in addition to the ones discussed in Section 4).

$$G : \{ \neg(PC \in CR) \wedge W_{en} \wedge (D_{addr} \in CTR) \rightarrow reset \} \quad (15)$$

$$G : \{ DMA_{en} \wedge (DMA_{addr} \in CTR) \rightarrow reset \} \quad (16)$$

LTl Specification (15) ensures that regular software does not modify \mathcal{P}_{rv} ’s counter, while (16) ensures that the same is not possible via the DMA controller. FSMs in Figures 8 and 11, corresponding to HW-Mod access control and DMA sub-modules, must be modified to transition into *Reset* state according to these new conditions. In addition, LTl Specification (7) must be relaxed to allow SW-Att to write to CTR . Implementation and verification of the modified version of these sub-modules are publicly available at VRASED’s repository [1] as an optional part of the design.

C VRASED API

VRASED ensures that any violation of secure RA properties is detected and causes the system to reset. However, benign applications running on the MCU must also comply with VRASED rules to execute successfully.

For example, suppose that a benign application receives an attestation request from $\mathcal{V}rf$. It then needs to set up MCU software state before SW-Att can execute. This includes: disabling interrupts, setting the stack pointer to the reserved secure stack, and storing the previous stack pointer, in order to restore software state after SW-Att execution completes. If the application fails to do this, even though RA security still holds, the system might reach an unexpected state due to incorrect set-up before or after SW-Att execution. For example, suppose that interrupts were (erroneously) not disabled before calling SW-Att, and an interrupt occurs during SW-Att execution, thus aborting the application. Though not a violation of secure RA properties, this can clearly harm the benign application.

Furthermore, setting up execution environment for SW-Att requires knowledge of low-level architecture and assembly instructions in order to deal directly with register state. Assuming such knowledge might be unrealistic or unnecessary for a typical application developer, who codes applications using a high-level programming language, e.g., C. To this end, we provide an API to SW-Att that takes care of necessary configuration on the application’s behalf. VRASED API implements appropriate configurations, saves the application state, calls SW-Att, and resumes the software state after SW-Att execution. This makes all VRASED specifics transparent to the application developer, making RA an easy-to-use service: a simple function call.

VRASED API implementation is shown in Figure 15. It starts by copying $\mathcal{V}rf$ ’s Chal to the designated physical memory location that will be read by SW-Att. Next, to comply with atomicity, it disables interrupts. Before calling SW-Att, the current value of the stack pointer⁷ is saved and set to point to the base of the secure stack. This is necessary to comply with the Key Confidentiality property which ensures that SW-Att can only execute on the reserved stack. With that last step, software state is ready for SW-Att execution. After SW-Att execution, the original stack pointer value and values of the registers used to store the original stack pointer are restored and interrupts are enabled. At this point, execution of the application can continue and the application can reply to $\mathcal{V}rf$ ’s request with the attestation result.

Remark. VRASED API makes it easy for programmers to comply with HW-Mod requirements before calling SW-Att. The API itself does not (and should not) provide any security properties, since it is executed before and after SW-Att invocation to save and resume application execution state. Such code is not part of SW-Att and resides in regular program memory, where it is treated accordingly by HW-Mod’s access control rules. In summary, it is **not part of the verified design**.

D FPGA Deployment and Sample Application

VRASED’s design can be synthesized and deployed in real

IoT/CPS environments. To demonstrate its practicality and ease of use we provide, as part of VRASED’s repository [1], a ready-to-go synthesizable version of the architecture for the commodity FPGA Basys3⁸ (depicted in Figure 16). The design can be easily ported to other FPGA models by mapping the input and output ports accordingly in the Verilog’s constraints file.

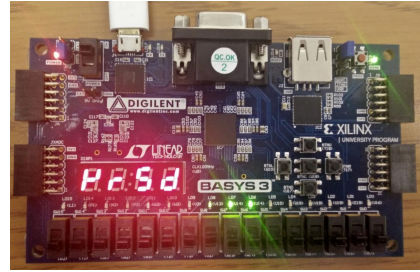

Figure 16: Basys3 FPGA running VRASED’s HW architecture depicted in Figure 3

```

1 int main() {
2     uint8_t challenge[32];
3     uint8_t response[32];
4     my_memset(challenge, 32, 1);
5
6     P3DIR = 0xFF;
7     P3OUT = 0x00;
8     uint32_t count = 0;
9     volatile uint8_t buffer = 0;
10    while (1) {
11        while (count < 3000000) {
12            count ++;
13        }
14        count = 0;
15        P3OUT++;
16        if (P3OUT % 10 == 0) {
17            buffer = P3OUT;
18            P3OUT = 0xFF;
19            VRASED(challenge, response);
20            count = 0;
21            P3OUT = buffer;
22        }
23    }
24    return 0;
25 }
26

```

Figure 17: Toy MSP430 application demo running VRASED’s RA in real HW

Figure 17 presents a toy sample application written in MSP430 C. In it, P3 is an 8-bit General Purpose Input Output (GPIO) port which, in the synthesized HW, is connected to LEDs 0-7 of Basys3 FPGA. Lines 2-4 allocate buffers for the attestation challenge and response and initialize the challenge buffer. In practice, the challenge is received from $\mathcal{V}rf$ via communication channels such as MSP430 Universal Asynchronous Receiver/Transmitter (UART). For the sake of clarity and brevity we omit the communication step from the example and set the challenge to a constant. Line 6 in Figure 17 sets P3 GPIO as output (i.e., an actuator port) and line 7 initializes all 8 bits to zero, making all LEDs initially off. The main application loop starts at line 10; at every iteration an

⁷In MSP430, the stack pointer is the register r1.

⁸<https://store.digilentinc.com/basys-3-artix-7-fpga-trainer-board-recommended-for-introductory-users/>

artificial delay of 3 million integer increments is introduced and then P3 output value is incremented. This results in a binary counter being displayed on the 8 LEDs. At every time the counter value reached a multiple of 10 (line 16), all LEDs turn on (line 18) and the RA procedure is called in line 19 (by default VRASED RA is computed in the entire program memory, but the range is configurable and allows for data memory attestation as well). The LEDs remain on until the end of RA

computation. After completion of attestation, the attestation result is saved in the `response` buffer and the counter resumes. In practical applications, such result can be reported back to $\mathcal{V}rf$ (via UART) as an authenticated measurement of the device's state. A demo video of this application running on real hardware and computing RA in a small fraction of a second is available on VRASED's repository [1].