

A Local-Search Algorithm for Steiner Forest

Martin Groß^{*†} Anupam Gupta[‡] Amit Kumar[§] Jannik Matuschke^{¶†}
Daniel R. Schmidt^{||†} Melanie Schmidt^{#†} José Verschae[‡]

July 11, 2017

Abstract

In the *Steiner Forest* problem, we are given a graph and a collection of source-sink pairs, and the goal is to find a subgraph of minimum total length such that all pairs are connected. The problem is APX-Hard and can be 2-approximated by, e.g., the elegant primal-dual algorithm of Agrawal, Klein, and Ravi from 1995.

We give a local-search-based constant-factor approximation for the problem. Local search brings in new techniques to an area that has for long not seen any improvements and might be a step towards a combinatorial algorithm for the more general survivable network design problem. Moreover, local search was an essential tool to tackle the dynamic MST/Steiner Tree problem, whereas dynamic Steiner Forest is still wide open.

It is easy to see that any constant factor local search algorithm requires steps that add/drop many edges together. We propose natural local moves which, at each step, either (a) add a shortest path in the current graph and then drop a bunch of inessential edges, or (b) add a set of edges to the current solution. This second type of moves is motivated by the potential function we use to measure progress, combining the cost of the solution with a penalty for each connected component. Our carefully-chosen local moves and potential function work in tandem to eliminate bad local minima that arise when using more traditional local moves.

Our analysis first considers the case where the local optimum is a single tree, and shows optimality w.r.t. moves that add a single edge (and drop a set of edges) is enough to bound the locality gap. For the general case, we show how to “project” the optimal solution onto the different trees of the local optimum without incurring too much cost (and this argument uses optimality w.r.t. both kinds of moves), followed by a tree-by-tree argument. We hope both the potential function, and our analysis techniques will be useful to develop and analyze local-search algorithms in other contexts.

^{*}Institut für Mathematik, Technische Universität Berlin, gross@math.tu-berlin.de.

[†]Supported by the DFG within project A07 of CRC TRR 154.

[‡]Department of Computer Science, Carnegie Mellon University, anupamg@cs.cmu.edu.

[§]Department of Computer Science and Engineering, Indian Institute of Technology, amitk@cse.iitd.ernet.in.

[¶]TUM School of Management, Technische Universität München, jannik.matuschke@tum.de.

[†]Partly supported by the German Academic Exchange Service (DAAD).

^{||}Institut für Informatik, Universität zu Köln, schmidt@informatik.uni-koeln.de.

[#]Institut für Informatik, Universität Bonn, melanieschmidt@uni-bonn.de.

[‡]Facultad de Matemáticas & Escuela de Ingeniería, Pontificia Universidad Católica de Chile, jverschae@uc.cl. Partly supported by Nucleo Milenio Información y Coordinación en Redes ICM/FIC P10-024F.

1 Introduction

The Steiner Forest problem is the following basic network design problem: given a graph $G = (V, E)$ with edge-lengths d_e , and a set of source-sink pairs $\{\{s_i, t_i\}\}_{i=1}^k$, find a subgraph H of minimum total length such that each $\{s_i, t_i\}$ pair lies in the same connected component of H . This problem generalizes the Steiner Tree problem, and hence is APX-hard. The Steiner Tree problem has a simple 2-approximation, namely the minimum spanning tree on the terminals in the metric completion; however, the forest version does not have such obvious algorithms.

Indeed, the first approximation algorithm for this problem was a sophisticated and elegant primal-dual 2-approximation due to Agrawal, Klein, and Ravi [AKR95]. Subsequently, Goemans and Williamson streamlined and generalized these ideas to many other constrained network design problems [GW95]. These results prove an integrality gap of 2 for the natural cut-covering LP. Other proofs of this integrality gap were given in [Jai01, CS09]. No better LP relaxations are currently known (despite attempts in, e.g., [KLS05, KLSvZ08]), and improving the approximation guarantee of 2 remains an outstanding open problem. Note that all known constant-factor approximation algorithms for Steiner Forest were based on linear programming relaxations, until a recent greedy algorithm [GK15]. In this paper, we add to the body of techniques that give constant-factor approximations for Steiner Forest. The main result of this paper is the following:

Theorem 1. *There is a (non-oblivious) local search algorithm for Steiner Forest with a constant locality gap. It can be implemented to run in polynomial time.*

The Steiner Forest problem is a basic network problem whose approximability has not seen any improvements in some time. We explore new techniques to attacking the problem, with the hope that these will give us more insights into its structure. Moreover, for many problems solved using the constrained forest approach of [GW95], the only constant factor approximations known are via the primal-dual/local-ratio approach, and it seems useful to bring in new possible techniques. Another motivation for our work is to make progress towards obtaining combinatorial algorithms for the survivable network design problem. In this problem, we are given connectivity requirements between various source-sink pairs, and we need to find a minimum cost subset of edges which provide this desired connectivity. Although we know a 2-approximation algorithm for the survivable network design problem [Jai01] based on iterative rounding, obtaining a combinatorial constant-factor approximation algorithm for this problem remains a central open problem [WS11]. So far, all approaches of extending primal-dual or greedy algorithms to survivable network design have only had limited success. Local search algorithms are more versatile in the sense that one can easily *propose* algorithms based on local search for various network design problems. Therefore, it is important to understand the power of such algorithms in such settings. We take a step towards this goal by showing that such ideas can give constant-factor approximation algorithms for the Steiner Forest problem.

Finally, we hope this is a step towards solving the *dynamic Steiner Forest* problem. In this problem, terminal pairs arrive online and we want to maintain a constant-approximate Steiner Forest while changing the solution by only a few edges in each update. Several of the approaches used for the Steiner *Tree* case (e.g., in [MSVW12, GJK13, LOP⁺15]) are based on local-search, and we hope our local-search algorithm for Steiner Forest in the offline setting will help solve the dynamic Steiner Forest problem, too.

1.1 Our Techniques

One of the challenges with giving a local-search algorithm for Steiner Forest is to find the right set of moves. Indeed, it is easy to see that simple-minded approaches like just adding and dropping a constant number of edges at each step is not enough. E.g., in the example of Figure 1, the improving moves must add an edge

and remove multiple edges. (This holds even if we take the metric completion of the graph.) We therefore consider a natural generalization of simple edge swaps in which we allow to add paths and remove multiple edges from the induced cycle.

Local Moves: Our first task is to find the “right” moves that add/remove many edges in each “local” step. At any step of the algorithm, our algorithm has a feasible forest, and performs one of these local moves (which are explained in more detail in §3):

- **edge/set swaps:** Add an edge to a tree in the forest, and remove one or more edges from the cycle created.
- **path/set swaps:** Add a shortest-path between two vertices of a tree in the forest, and again remove edges from the cycle created.
- **connecting moves:** Connect some trees of the current forest by adding edges between them.

At the end of the algorithm, we apply the following post-processing step to the local optimum:

- **clean-up:** Delete all inessential edges. (An edge is *inessential* if dropping it does not alter the feasibility of the solution.)

Given these local moves, the challenge is to bound the locality gap of the problem: the ratio between the cost of a local optimum and that of the global optimum.

The Potential: The connecting moves may seem odd, since they only increase the length of the solution. However, a crucial insight behind our algorithm is that we do not perform local search with respect to the total length of the solution. Instead we look to improve a different potential ϕ . (In the terminology of [Ali94, KMSV98], our algorithm is a *non-oblivious* local search.) The potential $\phi(T)$ of a tree T is the total length of its edges, plus the distance between the furthest source-sink pair in it, which we call its *width*. The potential of the forest \mathcal{A} is the sum of the potentials of its trees. We only perform moves that cause the potential of the resulting solution to decrease.

In §A.2 we give an example where performing the above moves with respect to the total length of the solution gives us local optima with cost $\Omega(\log n) \cdot \text{OPT}$ — this example is useful for intuition for why using this potential helps. Indeed, if we have a forest where the distance between two trees in the forest is much less than both their widths, we can merge them and reduce the potential (even though we increase the total length). So the trees in a local optimum are “well-separated” compared to their widths, an important property for our analysis.

The Proof: We prove the constant locality gap in two conceptual steps.

As the first step, we assume that the local optimum happens to be a single tree. In this case we show that the essential edges of this tree T have cost at most $\mathcal{O}(\text{OPT})$ —hence

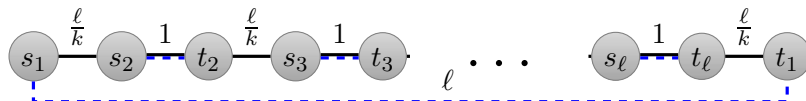

Figure 1: The black edges (continuous lines) are the current solution. If $\ell \gg k$, we should move to the blue forest (dashed lines), but any improving move must change $\Omega(k)$ edges. Details can be found in §A.1.

the final removal of inessential edges gives a good solution. To prove this, we need to charge our edges to OPT 's edges. However, we cannot hope to charge single edges in our solution to single edges in OPT —we need to charge multiple edges in our solution to edges of OPT . (We may just have more edges than OPT does. More concretely, this happens in the example from Figure 1, when $\ell = \Theta(k)$ and we are at the black tree and OPT is the blue forest.) So we consider edge/set swaps that try to swap some subset S of T 's edges for an edge f of OPT . Since such a swap is non-improving at a local optimum, the cost of S is no more than that of f . Hence, we would like to partition T 's edges into groups and find an $O(1)$ -to-1 map of groups to edges of OPT of no less cost. Even if we cannot find an explicit such map, it turns out that Hall's theorem is the key to showing its existence.

Indeed, the intuition outlined above works out quite nicely if we imagine doing the local search with respect to the total length instead of the potential. The main technical ingredient is a partitioning of our edges into equivalence classes that behave (for our purposes) “like single edges”, allowing us to apply a Hall-type argument. This idea is further elaborated in §4.1 with detailed proofs in §6. However, if we go back to considering the potential, an edge/set swap adding f and removing S may create multiple components, and thus increase the width part of the potential. Hence we give a more delicate argument showing that similar charging arguments work out: basically we now have to charge to the width of the globally optimal solution as well. A detailed synopsis is presented in §4.2, and the proofs are in §7.

The second conceptual step is to extend this argument to the case where we can perform all possible local moves, and the local optimum is a forest \mathcal{A} . If OPT’s connected components are contained in those of \mathcal{A} , we can do the above analysis for each \mathcal{A} -component separately. So imagine that OPT has edges that go between vertices in different components of \mathcal{A} . We simply give an algorithm that takes OPT and “projects” it down to another solution OPT’ of comparable cost, such that the new projected solution OPT’ has connected components that are contained in the components of \mathcal{A} . We find the existence of a cheap projected solution quite surprising; our proof crucially uses the optimality of the algorithm’s solution under both path/set swaps and connecting moves. Again, a summary of our approach is in §5, with proofs in §8.

Polynomial-time Algorithm. The locality gap with respect to the above moves is at most 46. Finally, we show that the swap moves can be implemented in polynomial time, and the connecting moves can be approximated to within constant factors. Indeed, a c -approximation for *weighted k -MST* gives a $23(1+c) + \varepsilon$ -approximation. Applying a weighted version of Garg’s 2-approximation [Gar05, Gar16] yields $c = 2$. The resulting approximation guarantee is 69 (compared to 96 for [GK15]). Details on this can be found in §B.

1.2 Related Work

Local search techniques have been very successful for providing good approximation guarantees for a variety of problems: e.g., network design problems such as low-degree spanning trees [FR94], min-leaf spanning trees [LR96, SO98], facility location and related problems, both uncapacitated [KPR00, AGK⁺04] and capacitated [PTW01], geometric k -means [KMN⁺04], mobile facility location [AFS13], and scheduling problems [PS15]. Other examples can be found in, e.g., the book of Williamson and Shmoys [WS11]. More recent are applications to optimization problems on planar and low-dimensional instances [CM15, CG15]. In particular, the new PTAS for low dimensional k -means in is based on local search [CAKM16, FRS16].

Local search algorithms have also been very successful in practice – e.g., the widely used Lin-Kernighan heuristic [LK73] for the travelling salesman problem, which has been experimentally shown to perform extremely well [Hel00].

Imase and Waxman [IW91] defined the dynamic Steiner tree problem where vertices arrive/depart online, and a few edge changes are performed to maintain a near-optimal solution. Their analysis was improved by [MSVW12, GGK13, GK14, LOP⁺15], but extending it to Steiner Forest remains wide open.

2 Preliminaries

Let $G = (V, E)$ be an undirected graph with non-negative edge weights $d_e \in \mathbb{R}_{\geq 0}$. Let $n := |V|$. For $W \subseteq V$, let $G[W] = (W, E[W])$ be the vertex-induced subgraph, and for $F \subseteq E$, $G[F] = (V[F], F)$ the edge-induced subgraph, namely the graph consisting of the edges in F and the vertices contained in them. A forest is a set of edges $F \subseteq E$ such that $G[F]$ is acyclic.

For a node set $W \subseteq V$ and an edge set $F \subseteq E$, let $\delta_F(W)$ denote the edges of F leaving W . Let $\delta_F(A : B) := \delta_F(A) \cap \delta_F(B)$ for two disjoint node sets $A, B \subseteq V$ be the set of edges that go between A

and B . For forests $F_1, F_2 \subseteq E$ we use $\delta_F(F_1 : F_2) := \delta_F(V[F_1] : V[F_2])$. We may drop the subscript if it is clear from the context.

Let $\mathfrak{T} \subseteq \{\{v, \bar{v}\} \mid v, \bar{v} \in V\}$ be a set of terminal pairs. Denote the shortest-path distance between u and \bar{u} in (G, d) by $\text{dist}_d(u, \bar{u})$. Let n_t be the number of terminal pairs. We number the pairs according to non-decreasing shortest path distance (ties broken arbitrarily). Thus, $\mathfrak{T} = \{\{u_1, \bar{u}_1\}, \dots, \{u_{n_t}, \bar{u}_{n_t}\}\}$ and $i < j$ implies $\text{dist}_d(u_i, \bar{u}_i) \leq \text{dist}_d(u_j, \bar{u}_j)$. This numbering ensures consistent tie-breaking throughout the paper. We say that $G = (V, E)$, the weights d and \mathfrak{T} form a *Steiner Forest instance*. We often use \mathcal{A} to denote a feasible Steiner forest held by our algorithm and \mathcal{F} to denote an optimal/good feasible solution to which we compare \mathcal{A} .

Width. Given a connected set of edges E' , the *width* $w(E')$ of E' is the maximum distance (in the original graph) of any terminal pair connected by E' : i.e., $w(E') = \max_{\{u, \bar{u}\} \in \mathfrak{T}, u, \bar{u} \in V[E']} \text{dist}_d(u, \bar{u})$. Notice that $w(E')$ is the width of the pair $\{u_i, \bar{u}_i\}$ with the largest i among all pairs in $V[E']$. We set $\text{inDex}(E') := \max\{i \mid u_i, \bar{u}_i \in V[E']\}$, i.e., $w(E') = \text{dist}_d(u_{\text{inDex}(E')}, \bar{u}_{\text{inDex}(E')})$.

For a subgraph $G[F] = (V[F], F)$ given by $F \subseteq E$ with connected components $E_1, \dots, E_l \subseteq F$, we define the *total width* of F to be the sum $w(F) := \sum_{i=1}^l w(E_i)$ of the widths of its connected components. Let $d(F) := \sum_{e \in F} d_e$ be the sum of edge lengths of edges in F and define

$$\phi(F) := d(F) + w(F).$$

By the definition of the width, it follows that $d(F) \leq \phi(F) \leq 2d(F)$.

3 The Local Search Algorithm

Our local-search algorithm starts with a feasible solution \mathcal{A} , and iteratively tries to improve it. Instead of looking at the actual edge cost $d(\mathcal{A})$, we work with the potential $\phi(\mathcal{A})$ and decrease it over time.

In the rest of the paper, we say a move changing \mathcal{A} into \mathcal{A}' is *improving* if $\phi(\mathcal{A}') < \phi(\mathcal{A})$. A solution \mathcal{A} is *<move>-optimal* with respect to certain kind of move if no moves of that kind are improving.

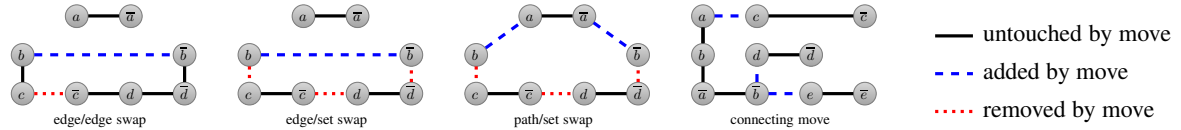

Figure 2: Our different moves.

Swaps. Swaps are moves that start with a cycle-free feasible solution \mathcal{A} , add some edges and remove others to get to another cycle-free feasible solution \mathcal{A}' .

- The most basic swap is: *add an edge e creating a cycle, remove an edge f from this cycle*. This is called an *edge/edge swap* (e, f) .
- We can slightly generalize this: *add an edge e creating a cycle, and remove a subset S of edges from this cycle $C(e)$* . This is called the *edge/set swap* (e, S) . Edge/edge swaps are a special case of edge/set swaps, so edge/set swap-optimality implies edge/edge swap-optimality.

There may be many different subsets of $C(e)$ we could remove. A useful fact is that if we fix some edge $f \in C(e)$ to remove, this uniquely gives a maximal set $R(e, f) \subseteq C(e)$ of edges that can be removed along with f after adding e without violating feasibility. Indeed, $R(e, f)$ contains f , and also all edges on $C(e)$ that can be removed in $\mathcal{A} \cup \{e\} \setminus \{f\}$ without destroying feasibility. (See Lemma 13 for a formalization.)

Moreover, given a particular $R(e, f)$, we could remove any subset $S \subseteq R(e, f)$. If we were doing local search w.r.t. $d(\mathcal{A})$, there would be no reason to remove a proper subset. But since the local moves try to reduce $\phi(\mathcal{A})$, removing a subset of $R(e, f)$ may be useful. If e_1, \dots, e_ℓ are the edges in $R(e, f)$ in the order they appear on $C(e)$, we only need swaps where S consists of edges e_i, \dots, e_j that are consecutive in the above order. There are $\mathcal{O}(n^2)$ sets $S \subseteq R(e, f)$ that are consecutive.* Moreover, there are at most $n - 1$ choices for e and $\mathcal{O}(n)$ choices for f , so the number of edge/set swaps is polynomial.

- A further generalization: we can pick two vertices u, v lying in some component T , add a shortest-path between them (in the current solution, where all other components are shrunk down to single points, and the vertices/edges in $T \setminus \{u, v\}$ are removed). This creates a cycle, and we want to remove some edges. We now imagine that we added a “virtual” edge $\{u, v\}$, and remove a subset of consecutive edges from some $R(\{u, v\}, f) \subseteq C(\{u, v\})$, just as if we’d have executed an edge/set swap with the “virtual” edge $\{u, v\}$. We call such a swap a *path/set swap* (u, v, S) .

Some subtleties: Firstly, the current solution \mathcal{A} may already contain an edge $\{u, v\}$, but the uv -shortest-path we find may be shorter because of other components being shrunk. So this move would add this shortest-path and remove the direct edge $\{u, v\}$ —indeed, the cycle $C(uv)$ would consist of two parallel edges, and we’d remove the actual edge $\{u, v\}$. Secondly, although the cycle contains edges from many components, only edges within T are removed. Finally, there are a polynomial number of such moves, since there are $\mathcal{O}(n^2)$ choices for u, v , $\mathcal{O}(n)$ choices for f , and $\mathcal{O}(n^2)$ consecutive removal sets S .

Note that edge/set swaps never decrease the number of connected components of \mathcal{A} , but path/set swaps may increase or decrease the number of connected components.

Connecting moves. Connecting moves reduce the number of connected components by adding a set of edges that connect some of the current components. Formally, let $G_{\mathcal{A}}^{\text{all}}$ be the (multi)graph that results from contracting all connected components of \mathcal{A} in G , deleting loops and keeping parallel edges. A *connecting move* (denoted $\text{conn}(T)$) consists of picking a tree in $G_{\mathcal{A}}^{\text{all}}$, and adding the corresponding edges to \mathcal{A} . The number of possible connecting moves can be large, but Section B.1 discusses how to do this approximately, using a k -MST procedure.

Note that connecting moves cause $d(\mathcal{A}') > d(\mathcal{A})$, but since our notion of improvement is with respect to the potential ϕ , such a move may still cause the potential to decrease.

In addition to the above moves, the algorithm runs the following post-processing step at the end.

Clean-up. Remove the unique maximal edge set $S \subseteq \mathcal{A}$ such that $\mathcal{A} \setminus S$ is feasible, i.e., erase all unnecessary edges. This might increase $\phi(\mathcal{A})$, but it will never increase $d(\mathcal{A})$.

Checking whether an improving move exists is polynomial except for connecting moves, which we can do approximately (see §B.1). Thus, the local search algorithm can be made to run in polynomial time by using standard methods (see § B).

4 In Which the Local Optimum is a Single Tree

We want to bound the cost of a forest that is locally optimal with respect to the moves defined above. To start, let us consider a simpler case: suppose we were to find a single tree T that is optimal with respect to just the *edge/edge* and *edge/set* swaps. (Recall that edge/set swaps add an edge and remove a consecutive

*In fact, we only need five different swaps (e, S) for the following choices of consecutive sets S : The set $S = \{f\}$, the complete set $S = R(e, f)$, and three sets of the form $S = \{e_1, \dots, e_i\}$, $S = \{e_{i+1}, \dots, e_j\}$ and $S = \{e_{j+1}, \dots, e_\ell\}$ for specific indices i and j . How to obtain the values for i and j is explained in Section 4.1.

subset of the edges on the resulting cycle, while maintaining feasibility. Also, recall that optimality means that no such moves cause the potential ϕ to decrease.) Our main result of this section is the following:

Corollary 2. *Let $G = (V, E)$ be a graph, let d_e be the cost of edge $e \in E$ and let $\mathfrak{T} \subseteq V \times V$ be a set of terminal pairs. Let $\mathcal{A}, \mathcal{F} \subseteq E$ be two feasible Steiner forests for (G, d, \mathfrak{T}) with $V[\mathcal{A}] = V[\mathcal{F}]$. Assume that \mathcal{A} is a tree and that \mathcal{A} is swap-optimal with respect to \mathcal{F} and ϕ under edge/edge and edge/set swaps. Denote by \mathcal{A}' the modified solution where all inessential edges have been dropped from \mathcal{A} . Then,*

$$d(\mathcal{A}') \leq 10.5 \cdot d(\mathcal{F}) + w(\mathcal{F}) \leq 11.5 \cdot d(\mathcal{F}).$$

The actual approximation guarantee is 42 for this case: indeed, Corollary 2 assumes $V[\mathcal{A}] = V[\mathcal{F}]$, which can be achieved (by taking the metric completion on the terminals) at the cost of a factor 2.

The intuition here comes from a proof for the optimality of edge/edge swaps for the Minimum Spanning tree problem. Let \mathcal{A} be the tree produced by the algorithm, and \mathcal{F} the reference (i.e., optimal or near-optimal) solution, with $V[\mathcal{A}] = V[\mathcal{F}]$. Suppose we were looking for a minimum spanning tree instead of a Steiner forest: one way to show that edge/edge swaps lead to a global optimum is to build a bipartite graph whose vertices are the edges of \mathcal{A} and \mathcal{F} , and which contains edge (e, f) when $f \in \mathcal{F}$ can be swapped for $e \in \mathcal{A}$ and $d_e \leq d_f$. Using the fact that all edge/edge swaps are non-improving, we can show that there exists a perfect matching between the edges in \mathcal{A} and \mathcal{F} , and hence the cost of \mathcal{A} is at most that of \mathcal{F} .

Our analysis is similar in spirit. Of course, we now have to (a) consider edge/set swaps, (b) do the analysis with respect to the potential ϕ instead of just edge-lengths, and (c) we cannot hope to find a perfect matching because the problem is NP-hard. These issues make the proofs more complicated, but the analogies still show through.

4.1 An approximation guarantee for trees and d

In this section, we conduct a thought-experiment where we imagine that we get a connected tree on the terminals which is optimal for edge/set swaps *with respect to just the edge lengths, not the potential*. In very broad strokes, we define an equivalence relation on the edges of \mathcal{A} , and show a constant-to-1 cost-increasing map from the resulting equivalence classes to edges of \mathcal{F} —again mirroring the MST analysis—and hence bounding the cost of \mathcal{A} by a constant times the cost of \mathcal{F} . The analysis of the real algorithm in §4.2 builds on the insights we develop here.

Some Definitions. The crucial equivalence relation is defined as follows: For edges $e, f \in \mathcal{A}$, let $T_{e,f}$ be the connected component of $\mathcal{A} \setminus \{e, f\}$ that contains the unique e - f -path in \mathcal{A} . We say e and f are *compatible w.r.t. \mathcal{F}* if $e = f$ or if there are no \mathcal{F} -edges leaving $T_{e,f}$, and denote it by $e \sim_{cp} f$. In Lemma 6 we show that \sim_{cp} is an equivalence relation, and denote the set of equivalence classes by \mathfrak{S} .

An edge is *essential* if dropping it makes the solution infeasible. If T_1, T_2 are the connected components of $\mathcal{A} \setminus \{e\}$, then e is called *safe* if at least one edge from \mathcal{F} crosses between T_1 and T_2 . Observe that any essential edge is safe, but the converse is not true: safe edges can be essential or inessential. However, it turns out that the set S_u of all unsafe edges in \mathcal{A} forms an equivalence class of \sim_{cp} . Hence, all other equivalence classes in \mathfrak{S} contain only safe edges. Moreover, these equivalence classes containing safe edges behave like single edges in the following sense. (Proof in Lemma 14 in §6.)

- (1) Each equivalence class S lies on a path in \mathcal{A} .
- (2) For any edge $f \in \mathcal{F}$, either S is completely contained in the fundamental cycle $C_{\mathcal{A}}(f)$ obtained by adding f to \mathcal{A} , or $S \cap C_{\mathcal{A}}(f) = \emptyset$.
- (3) If $(\mathcal{A} \setminus \{e\}) \cup \{f\}$ is feasible, and e belongs to equivalence class S , then $(\mathcal{A} \setminus S) \cup \{f\}$ is feasible. (This last property also trivially holds for $S = S_u$.)

Charging. We can now give the bipartite-graph-based charging argument sketched above.

Theorem 3. *Let $I = (V, E, \mathfrak{S}, d)$ be a Steiner Forest instance and let \mathcal{F} be a feasible solution for I . Furthermore, let $\mathcal{A} \subseteq E$ be a feasible tree solution for I . Assume that $V[\mathcal{F}] = V[\mathcal{A}]$. Let $\Delta : \mathfrak{S} \rightarrow \mathbb{R}$ be a cost function that assigns a cost to all $S \in \mathfrak{S}$. Suppose that $\Delta(S) \leq d_f$ for all pairs of $S \in \mathfrak{S} \setminus \{S_u\}$ and $f \in \mathcal{F}$ such that the cycle in $\mathcal{A} \cup \{f\}$ contains S . Then,*

$$\sum_{S \in \mathfrak{S} \setminus \{S_u\}} \Delta(S) \leq \frac{7}{2} \cdot \sum_{f \in \mathcal{F}} d_f.$$

Proof. Construct a bipartite graph $H = (A \cup B, E(H))$ with nodes $A := \{a_S \mid S \in \mathfrak{S} \setminus \{S_u\}\}$ and $B := \{b_f \mid f \in \mathcal{F}\}$. Add an edge $\{a_S, b_f\}$ whenever f closes a cycle in \mathcal{A} that contains S . By our assumption, if $\{a_S, b_f\} \in E(H)$ then $\Delta(S) \leq d_f$. Suppose that we can show that $\frac{7}{2} \cdot |N(X)| \geq |X|$ for all $X \subseteq A$, where $N(X) \subseteq B$ is the set of neighbors of nodes in X . By a generalization of Hall's Theorem (stated as Fact 15 in §6), this condition implies that there is an assignment $\alpha : E \rightarrow \mathbb{R}_+$ such that $\sum_{e \in \delta_H(a)} \alpha(e) \geq 1$ for all $a \in A$ and $\sum_{e \in \delta_H(b)} \alpha(e) \leq \frac{7}{2}$ for all $b \in B$. Hence

$$\sum_{S \in \mathfrak{S} \setminus \{S_u\}} \Delta(S) \leq \sum_{S \in \mathfrak{S} \setminus \{S_u\}} \sum_{e \in \delta_H(a_S)} \alpha(e) \Delta(S) = \sum_{f \in \mathcal{F}} \sum_{e \in \delta_H(b_f)} \alpha(e) \Delta(S) \leq \sum_{f \in \mathcal{F}} \sum_{e \in \delta_H(b_f)} \alpha(e) d_f \leq \frac{7}{2} \sum_{f \in \mathcal{F}} d_f.$$

It remains to show that $\frac{7}{2} \cdot |N(X)| \geq |X|$ for all $X \subseteq A$. To that aim, fix $X \subseteq A$ and define $\mathfrak{S}' := \{S \mid a_S \in X\}$. In a first step, contract all $e \in U := \bigcup_{S \in \mathfrak{S} \setminus \mathfrak{S}'} S$ in \mathcal{A} , and denote the resulting tree by $\mathcal{A}' := \mathcal{A}/U$.[†] Note that edges in each equivalence class are either all contracted or none are contracted. Also note that all unsafe edges are contracted, as $S_u \notin \mathfrak{S}'$. Apply the same contraction to \mathcal{F} to obtain $\mathcal{F}' := \mathcal{F}/U$, from which we remove all loops and parallel edges.

Let $f \in \mathcal{F}'$. Since \mathcal{A}' is a tree, f closes a cycle C in \mathcal{A}' containing at least one edge $e \in \mathcal{A}'$. Denoting the equivalence class of e by S_e , observing that all edges in \mathcal{A}' are safe, and using property (2) given above (formally, using Lemma 14(c)), we get that cycle C contains S_e . Hence the node $b_f \in B$ corresponding to f belongs to $N(a_{S_e}) \subseteq N(X)$. Thus, $|N(X)| \geq |\mathcal{F}'|$ and it remains to show that $\frac{7}{2} |\mathcal{F}'| \geq |X|$.

We want to find a unique representative for each $a_S \in X$. So we select an arbitrary root vertex $r \in V[\mathcal{A}']$ and orient all edges in \mathcal{A}' away from r . Every non-root vertex now has exactly one incoming edge. Every equivalence class $S \in \mathfrak{S}'$ consists only of safe edges, so it lies on a path (by Lemma 14(a)). Consider the two well-defined *endpoints* which are the outermost vertices of S on this path. For at least one of them, the unique incoming edge must be an edge in S . We represent S by one of the endpoints which has this property and call this representative r_S . Let $R \subseteq V[\mathcal{A}']$ be the set of all representative nodes. Since every vertex has an unique incoming edge, $S \neq S'$ implies that $r_S \neq r_{S'}$. Hence $|R| = |\mathfrak{S}'| = |X|$. Moreover, let R_1 and R_2 be the representatives with degrees 1 and 2 in \mathcal{A}' , and L be the set of leaves of \mathcal{A}' . As the number of vertices of degree at least 3 in a tree is bounded by the number of its leaves, the number of representatives of degree at least 3 in \mathcal{A}' is bounded by $|L|$. So $|X| \leq |R_1| + |R_2| + |L|$.

We now show that every $v \in R_2 \cup L$ is incident to an edge in \mathcal{F}' . First, consider any $v \in L$ and let e be the only edge in \mathcal{A}' incident to v . As e is safe, there must be an edge $f \in \mathcal{F}'$ incident to v . Now consider any $r_S \in R_2$ and let $e_1, e_2 \in \mathcal{A}'$ be the unique edges incident to r_S . Because r_S is the endpoint of the path corresponding to the equivalence class S , the edges e_1 and e_2 are not compatible. Hence there must be

[†]Formally, we define the graph $G[T]/e = (V[T]/e, T/e)$ for a tree T by $V[T]/e := V[T] \cup \{uv\} \setminus \{u, v\}$ and $T/e := T \setminus \delta(\{u, v\}) \cup \{\{w, uv\} \mid \{u, w\} \in T \vee \{v, w\} \in T\}$ for an edge $e = \{u, v\} \in E$, then set $G/U := G/e_1/e_2/\dots/e_k$ for $U = \{e_1, \dots, e_k\}$ and let T/U be the edge set of this graph. If $U \subseteq T$, then the contraction causes no loops or parallel edges, otherwise, we delete all loops or parallel edges.

an edge $f \in \mathcal{F}'$ incident to r_S . Because R_2 and L are disjoint and every edge is incident to at most two vertices, we conclude that $|\mathcal{F}'| \geq (|R_2| + |L|)/2$.

Finally, we show that $|\mathcal{F}'| \geq \frac{2}{3}|R_1|$. Let \mathcal{C} be the set of connected components of \mathcal{F}' in G/U . Let $\mathcal{C}' := \{T \in \mathcal{C} \mid |V[T] \cap R_1| \leq 2\}$ and $\mathcal{C}'' := \{T \in \mathcal{C} \mid |V[T] \cap R_1| > 2\}$. Note that no representative $r_S \in R_1$ is a singleton as every leaf of \mathcal{A}' is incident to an edge of \mathcal{F}' . We claim that $|T| \geq |V[T] \cap R_1|$ for every $T \in \mathcal{C}'$. Assume by contradiction that this was not true and let $T \in \mathcal{C}'$ with $|T| < |V(T) \cap R_1|$. This means that $V[T] \cap R_1$ contains exactly two representatives $r_S, r_{S'} \in R_1$ and T contains only the edge $\{r_S, r_{S'}\}$. Let $e \in S$ and $e' \in S'$ be the edges of \mathcal{A}' incident to r_S and $r_{S'}$, respectively. As e and e' are not compatible, there must be an edge $f \in \mathcal{F}'$ with exactly one endpoint in $\{r_S, r_{S'}\}$, a contradiction as this edge would be part of the connected component T . We conclude that $|T| \geq |V[T] \cap R_1|$ for every $T \in \mathcal{C}'$. Additionally, we have that $|T| \geq |V[T]| - 1 \geq \frac{2}{3}|V[T]|$ for all $T \in \mathcal{C}''$ as $|V[T]| > 2$. Therefore,

$$|\mathcal{F}'| = \sum_{T \in \mathcal{C}} |T| \geq \sum_{T \in \mathcal{C}'} |V[T] \cap R_1| + \sum_{T \in \mathcal{C}''} \frac{2}{3}|V[T] \cap R_1| \geq \frac{2}{3}|R_1|.$$

The three bounds together imply $|X| \leq |R_1| + |R_2| + |L| \leq \frac{3}{2}|\mathcal{F}'| + 2|\mathcal{F}'| = \frac{7}{2}|\mathcal{F}'|$. \square

We obtain the following corollary of Theorem 3.

Corollary 4. *Let $I = (V, E, \mathfrak{T}, d)$ be a Steiner Forest instance and let OPT be a solution for I that minimizes $d(OPT) = \sum_{e \in OPT} d_e$. Let $\mathcal{A} \subseteq E$ be feasible tree solution for I that does not contain inessential edges. Assume $V[\mathcal{A}] = V[OPT]$. If \mathcal{A} is edge/edge and edge/set swap-optimal with respect to OPT and d , then it holds that $\sum_{e \in \mathcal{A}} d_e \leq (7/2) \cdot \sum_{e \in OPT} d_e$.*

Proof. Since there are no inessential edges, $S_u = \emptyset$. We set $\Delta(S) := \sum_{e \in S} d_e$ for all $S \in \mathfrak{S}$. Let $f \in OPT$ be an edge that closes a cycle in \mathcal{A} that contains S . Then, $(\mathcal{A} \setminus \{e\}) \cup \{f\}$ is feasible for any single edge $e \in S$ because it is still a tree. By Lemma 14(d), this implies that $(\mathcal{A} \setminus S) \cup \{f\}$ is also feasible. Thus, we consider the swap that adds f and deletes S . It was not improving with respect to d , because \mathcal{A} is edge/set swap-optimal with respect to edges from OPT and d . Thus, $\Delta(S) = \sum_{e \in S} d_e \leq d_f$, and we can apply Theorem 3 to obtain the result. \square

4.2 An approximation guarantee for trees and ϕ

We now consider the case where a connected tree \mathcal{A} is output by the algorithm when considering the edge/set swaps, but now with respect to the potential ϕ (instead of just the total length as in the previous section). These swaps may increase the number of components, which may have large widths, and hence edge/set swaps that are improving purely from the lengths may not be improving any more. This requires a more nuanced analysis, though relying on ideas we have developed in the previous section.

Here is the high-level summary of this section. Consider some equivalence class $S \in \mathfrak{S} \setminus \{S_u\}$ of safe edges: these lie on a path (by Lemma 14(a)), hence look like this:

$$\boxed{w_0} \xrightarrow{e_1} \boxed{v_1 \rightarrow \dots \rightarrow w_1} \xrightarrow{e_2} \boxed{v_2 \rightarrow \dots \rightarrow w_{i-1}} \xrightarrow{e_i} \boxed{v_i \rightarrow \dots \rightarrow w_{\ell(S)-1}} \xrightarrow{e_{\ell(S)}} \boxed{v_{\ell(S)}},$$

where there are $\ell(S)$ edges and hence $\ell(S) + 1$ components formed by deleting S . We let In_S be set of the ‘‘inner’’ components (the ones containing $v_1, \dots, v_{\ell(S)-1}$), and $\text{In}_{S'}$ be the inner components except the two with the highest widths. Just taking the definition of ϕ , and adding and subtracting the widths of these ‘‘not-the-two-largest’’ inner components, we get

$$\phi(\mathcal{A}) = w(\mathcal{A}) + \sum_{e \in S_u} d_e + \underbrace{\sum_{S \in \mathfrak{S} \setminus \{S_u\}} \left(\sum_{i=1}^{\ell(S)} d_{e_i} - \sum_{K \in \text{In}_{S'}} w(K) \right)}_{\leq 10.5 \cdot d(\mathcal{F}) \text{ by Corollary 18}} + \underbrace{\sum_{S \in \mathfrak{S} \setminus \{S_u\}} \sum_{K \in \text{In}_S} w(K)}_{\leq w(\mathcal{F}) \text{ by Lemma 22}}.$$

As indicated above, the argument has two parts. For the first summation, look at the cycle created by adding edge $f \in \mathcal{F}$ to our solution \mathcal{A} . Suppose class S is contained in this cycle. We prove that edge/set swap optimality implies that $\sum_{i=1}^{\ell(S)} d_{e_i} - \sum_{K \in \text{In}_{S'}} w(K)$ is at most $3d_f$. (Think of this bound as being a weak version of the facts in the previous section, which did not have a factor of 3 but did not consider weights in the analysis.) Using this bound in Theorem 3 from the previous section gives us a matching that bounds the first summation by $3 \cdot (7/2) \cdot d(\mathcal{F})$. (A couple of words about the proofs: the bound above follows from showing that three different swaps must be non-improving, hence the factor of 3. Basically, we break the above path into three at the positions of the two components of highest width, since for technical reasons we do not want to disconnect these high-width components. Details are in §7.1.)

For the second summation, we want to sum up the widths of all the “all-but-two-widest” inner components, over all these equivalence classes, and argue this is at most $w(\mathcal{F})$. This is where our notions of safe and compatible edges comes into play. The crucial observations are that (a) given the inner components corresponding to some class S , the edges of some class S' either avoid all these inner components, or lie completely within some inner component; (b) the notion of compatibility ensures that these inner components correspond to distinct components of \mathcal{F} , so we can get more width to charge to; and (c) since we don’t charge to the two largest widths, we don’t double-charge these widths. The details are in §7.3.

5 In Which the Local Optimum may be a Forest

The main theorem. In the general case, both \mathcal{A} and \mathcal{F} may have multiple connected components. We assume that the distance function d is a metric. The first thing that comes to mind is to apply the previous analysis to the components individually. Morally, the main obstacle in doing so is in the proof of Theorem 3: There, we assume implicitly that no edge from \mathcal{F} goes between connected components of \mathcal{A} .[‡] This is vacuously true if \mathcal{A} is a single tree, but may be false if \mathcal{A} is disconnected. In the following, our underlying idea is to replace \mathcal{F} -edges that cross between the components of \mathcal{A} by edges that lie within the components of \mathcal{A} , thereby re-establishing the preconditions of Theorem 3. We do this in a way that \mathcal{F} stays feasible, and moreover, its cost increases by at most a constant factor. This allows us to prove that the local search has a constant locality gap.

Reducing to local tree optima. Suppose \mathcal{F} has no inessential edges to start. Then we convert \mathcal{F} into a collection of cycles (shortcutting non-terminals), losing a factor of 2 in the cost. Now observe that each “offending” \mathcal{F} -edge (i.e., one that goes between different components of \mathcal{A}) must be part of a path P in \mathcal{F} that connects some s, \bar{s} , and hence starts and ends in the same component of \mathcal{A} . This path P may connect several terminal pairs, and for each such pair s, \bar{s} , there is a component of \mathcal{A} that contains s and \bar{s} . Thus, P could be replaced by direct connections between s, \bar{s} within the components of \mathcal{A} . This would get rid of these “offending” edges, since the new connections would stay within components of \mathcal{A} . The worry is, however, that this replacement is too expensive. We show how to use connecting tree moves to bound the cost of the replacement.

Consider one cycle from \mathcal{F} , regarded as a circuit C in the graph $G_{\mathcal{A}}$ where the connected components A_1, \dots, A_p of \mathcal{A} are shrunk to single nodes, i.e., C consists of offending edges. The graph $G_{\mathcal{A}}$ might contain parallel edges and C might have repeated vertices. So C is a circuit, meaning that it is a potentially non-simple cycle, or, in other words, a Eulerian multigraph. The left and middle of Figure 3 are an example.

Index the A_j ’s such that $w(A_1) \leq \dots \leq w(A_p)$ and say that node j in $G_{\mathcal{A}}$ corresponds to A_j . Suppose C visits the nodes $v_1, \dots, v_{|C|}, v_1$ (where several of these nodes may correspond to the same component A_j) and that component A_j is visited n_j times by C . In the worst case, we may need to insert n_j different

[‡]More precisely, we need the slightly weaker condition that for each node $t \in V[\mathcal{A}]$, there is an \mathcal{F} -edge incident to t that does not leave the connected component of \mathcal{A} containing t .

s, \bar{s} connections into component A_j of \mathcal{A} , for all j . The key observation is that the total cost of our direct connections is at most $\sum_{i=1}^{|C|} n_i w(A_i)$. We show how to pay for this using the length of C .[§]

To do so, we use optimality with respect to all moves, in particular connecting moves. The idea is simple: We cut C into a set of trees that each define a valid connecting move. For each tree, the connecting move optimality bounds the widths of some components of \mathcal{A} by the length of the tree. E.g., $w(A_1) + w(A_4)$ is at most the length of the tree connecting A_1, A_4, A_5 in Figure 3. Observe that we did not list $w(A_5)$: Optimality against a connecting move with tree T relates the length of T to the width of all the components that T connects, *except* for the component with maximum width. We say a tree *pays* for A_j if it hits A_j , and also hits another A_j of higher width. So we need three properties: (a) the trees should collectively pack into the edges of the Eulerian multigraph C , (b) each tree hits each component A_j at most once, and (c) the number of trees that pay for A_j is at least n_j .

Assume that we found such a tree packing. For circuit C , if A_{j^*} is the component with greatest width hit by C , then using connecting move optimality for all the trees shows that

$$\sum_{j: A_j \text{ hit by } C, j \neq j^*} n_j w(A_j) \leq d(C).$$

In fact, even if we have c -approximate connection-move optimality, the right-hand side just gets multiplied by c . But what about $n_{j^*} w(A_{j^*})$? We can cut C into sub-circuits, such that each subcircuit C' hits A_{j^*} exactly once. To get this one extra copy of $w(A_{j^*})$, we use path/set swap optimality which tells us that the missing connection cannot be more expensive than the length of C . Thus, collecting all our bounds (see Lemma 36), adding all the extra connections to \mathcal{F} increases the cost to at most $2(1+c)d(\mathcal{F})$: the factor 2 to make \mathcal{F} Eulerian, $(1+c)$ to add the direct connections, using c -approximate optimality with respect to connecting moves and optimality with respect to path/set swaps. §B.2 discusses that $c \leq 2$.

Now each component A_j of \mathcal{A} can be treated separately, i.e., we can use Corollary 2 on each A_j and the portion of \mathcal{F} that falls into A_j . By combining the conclusions for all connected components, we get that

$$d(\mathcal{A}') \stackrel{\text{Cor. 2}}{\leq} 10.5d(\mathcal{F}') + w(\mathcal{F}') \leq 11.5d(\mathcal{F}') \stackrel{\text{Lem. 36}}{\leq} 23(1+c) \cdot d(\mathcal{F}) \leq 69 \cdot d(\mathcal{F})$$

for any feasible solution \mathcal{F} . This proves Theorem 1.

Obtaining a decomposition into connecting moves. It remains to show how to take C and construct the set of trees. If C had no repeated vertices (it is a simple cycle) then taking a spanning subtree would suffice. And even if C has some repeated vertices, decomposing it into suitable trees can be easy: E.g., if C is the “flower” graph on n vertices, with vertex 1 having two edges to each vertex $2, \dots, n$. Even though 1 appears multiple times, we find a good decomposition (see Figure 4). Observe, however, that breaking C into simple cycles and then doing something on each simple cycle would not work, since it would only pay 1 multiple times and none of the others.

The flower graph has a property that is a generalization of a simple cycle: We say that C is *minimally guarded* if (a) the largest vertex is visited only once (b) between two occurrences of the same (non-maximal) vertex, there is at least one larger number. The flower graph and the circuit at the top of Figure 5 have this property. We show that every minimally guarded circuit can be decomposed suitably by providing Algorithm 1. It iteratively finds trees that pay for all (non maximal) j with $j \leq z$ for increasing z . Figure 5 shows how the set of trees \mathfrak{M}_5 is converted into \mathfrak{M}_6 in order to pay for all occurrences of 6. Intuitively, we look where 6 falls into the trees in \mathfrak{M}_5 . Up to one occurrence can be included in a tree. If there are more occurrences, the tree has to be split into multiple trees appropriately. §8.1.2 explains the details.

Finally, Lemma 35 shows how to go from minimally guarded circuits to arbitrary C in a recursive fashion.

[§]We also need to take care of the additional width of the modified solution, but this is the easier part.

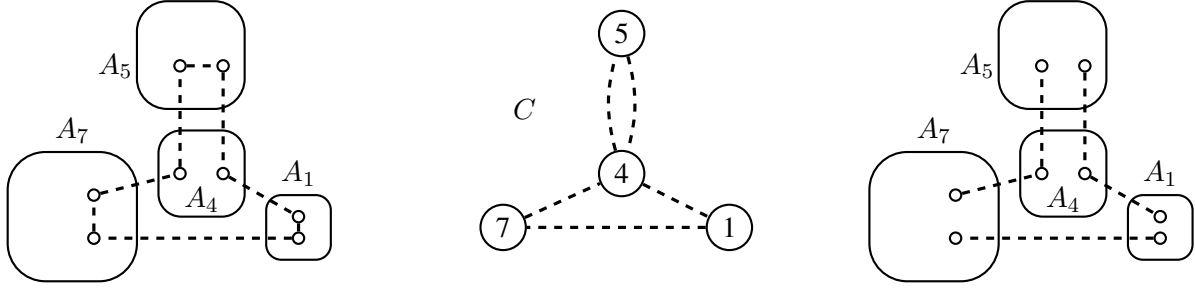

Figure 3: The charging argument with four components A_1, A_4, A_5 and A_7 of \mathcal{A} . The area of each component corresponds to its width. *On the left.* A cycle in \mathcal{F} . *In the middle.* The corresponding circuit (non-simple cycle) in $G_{\mathcal{A}}$. *On the right.* A suitable decomposition into connecting moves.

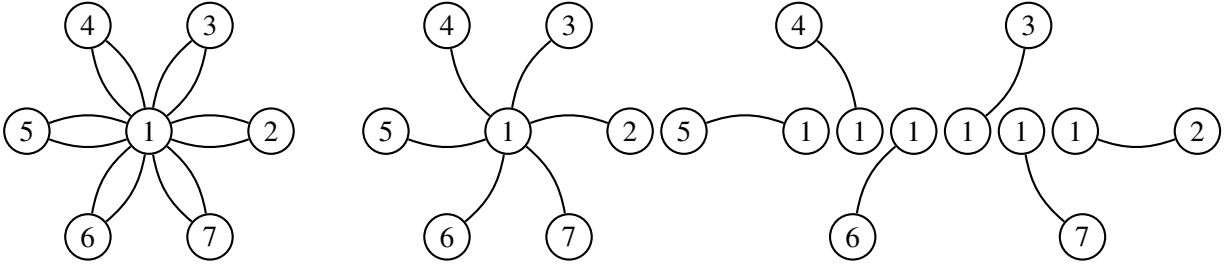

Figure 4: A flower graph. Even though the graph is a non-simple cycle, we can easily decompose it into trees that pay for each $j \neq 6$ at least n_j times (1 is paid for $7 = n_1 + 1$ times).

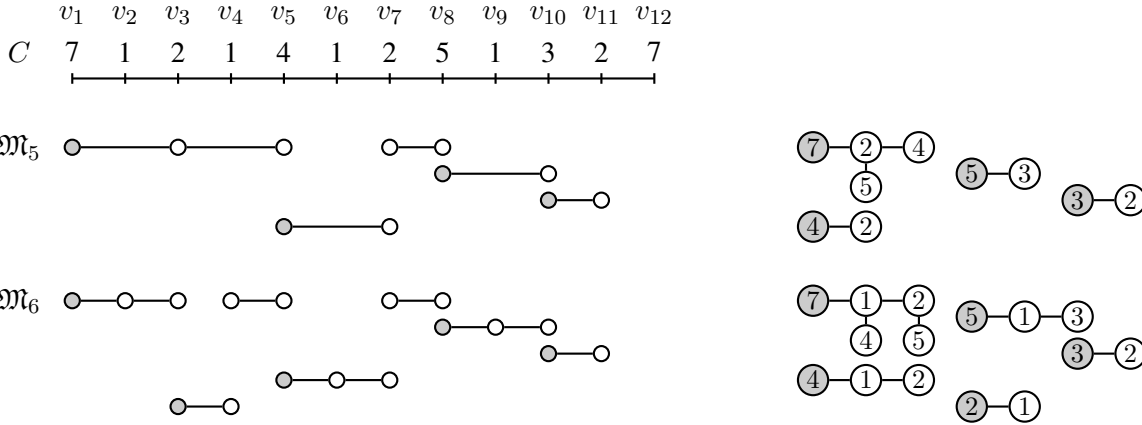
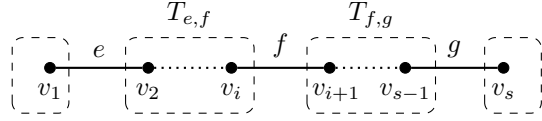

Figure 5: Two iterations of an example run of the Algorithm 1.

6 Proofs: Bounds on d when the Local Optimum is a Tree

Let $\mathcal{A}, \mathcal{F} \subseteq E$ be two feasible Steiner forests with respect to a set \mathfrak{T} of terminal pairs. We think of \mathcal{F} as an optimum or near optimum Steiner forest and of \mathcal{A} as a feasible solution computed by our algorithm. We assume that $V[\mathcal{A}] = V[\mathcal{F}]$ (this will be true when we use the results from this section later on). Throughout this section, we assume that \mathcal{A} is a tree (thus, it is a spanning tree on $V[\mathcal{A}] = V[\mathcal{F}]$). The following definition is crucial for our analysis.

Definition 5. Let $e = \{s, v_1\}, f = \{v_l, t\} \in \mathcal{A}$ be two edges. Consider the unique (undirected) path $P = s \xrightarrow{e} v_1 \rightarrow \dots \rightarrow v_l \xrightarrow{f} t$ in \mathcal{A} that connects e and f . Let $T_{e,f}$ be the connected component in



(a) First case: Edge f lies on the path from e to g . If an \mathcal{F} -edge is cut by $T_{f,g}$, the edges f and g cannot be compatible. Likewise, e and f cannot be compatible if an \mathcal{F} -edge is cut by $T_{e,f}$. Thus, no \mathcal{F} -edge is cut by $T_{e,f} \cup T_{f,g}$ and e and g are compatible.

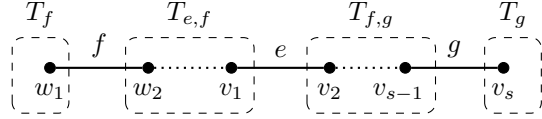

(b) Second case: The path connecting f to the path P from e to g touches an outer node of P . There can be no \mathcal{F} -edge between $T_{f,g}$ and $T_f \cup T_{e,f}$ because e and f are compatible. Likewise, no \mathcal{F} -edge can cross from $T_{f,g}$ to T_g because f and g are compatible. This shows that no \mathcal{F} -edge is cut by $T_{f,g}$ and thus, e and g are compatible.

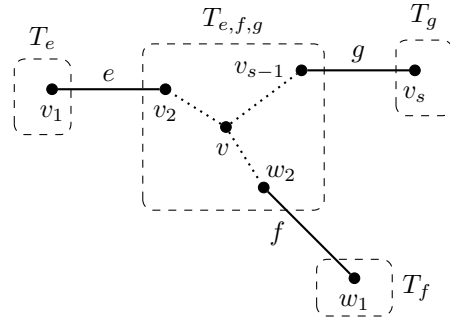

(c) Third case: The path connecting f to the path P from e to g touches an inner node v of P . Here, no \mathcal{F} -edge can cross from $T_{e,f,g}$ to T_e nor from T_f to T_g since e and f are compatible. The edges f and g being compatible, there also cannot be \mathcal{F} -edges from $T_{e,f,g}$ to T_g nor from T_e to T_f . Thus, no \mathcal{F} -edge is cut by $T_{e,f,g} \cup T_f$ and thus, the edges e and g are compatible.

Figure 6: The situation in Lemma 6.

$\mathcal{A} \setminus \{e, f\}$ that contains $P \setminus \{e, f\}$. We say that e and f are compatible with respect to \mathcal{F} if $e = f$ or if there are no \mathcal{F} -edges leaving $T_{e,f}$. In this case, we write $e \sim_{cp} f$.

Observe that \sim_{cp} is a reflexive and symmetric relation. We show that the relation is also transitive, i.e., it is an equivalence relation.

Lemma and Definition 6. *Let \mathcal{A} be feasible and let $e, f \in \mathcal{A}$ and $f, g \in \mathcal{A}$ be two pairs of compatible edges. Then, e and g are also compatible. In particular, \sim_{cp} is an equivalence relation. We denote the set of all equivalence classes of \sim_{cp} by \mathfrak{S} .*

Proof. Consider the unique path P that connects e and g in \mathcal{A} . This path has the form $v_1 \xrightarrow{e} v_2 \rightarrow \dots \rightarrow v_{s-1} \xrightarrow{g} v_s$. We distinguish three cases (see Figure 6).

For the first case, suppose that $f = \{v_i, v_{i+1}\}$ lies on P , for some $i \in \{2, \dots, s-2\}$. Let $T_{e,f}$ and $T_{f,g}$ be the connected components of $\mathcal{A} \setminus \{e, f, g\}$ that contain v_2, \dots, v_i and v_{i+1}, \dots, v_{s-1} , respectively. Assume by contradiction that $\delta_{\mathcal{F}}(T_{e,g}) \neq \emptyset$. Since $\delta_{\mathcal{F}}(T_{e,g}) \neq \emptyset$, it follows that $\delta_{\mathcal{F}}(T_{e,f}) \neq \emptyset$ or $\delta_{\mathcal{F}}(T_{f,g}) \neq \emptyset$. This is a contradiction to the assumption that e, f and f, g are compatible, respectively.

For the second case, suppose that f does not lie on P . Let R be the unique, possibly empty, path that connects f to P and suppose that R meets P at one of the outer nodes (w.l.o.g. assume that P and R meet in v_1). Thus, we are in the situation where $R \cup P$ has the form $w_1 \xrightarrow{f} w_2 \rightarrow \dots \rightarrow w_t \rightarrow v_1 \xrightarrow{e} v_2 \dots \rightarrow v_{s-1} \xrightarrow{g} v_s$. Consider the four connected components that $\mathcal{A} \setminus \{e, f, g\}$ decomposes into: The component T_f contains w_1 , the component $T_{f,e}$ contains w_2, \dots, w_t, v_1 , the component $T_{e,g}$ contains v_2, \dots, v_{s-1} and T_g contains v_s . If R is empty, the nodes w_2, w_t and v_1 coincide and $T_{f,e}$ contains only v_1 . Both the cuts $\delta_{\mathcal{F}}(T_{e,g} : T_g)$ and $\delta_{\mathcal{F}}(T_{e,g} : T_f)$ must be empty because f and g are compatible. The cut $\delta_{\mathcal{F}}(T_{e,g} : T_{f,e})$ must be empty because e and f are compatible. It follows that e and g are compatible.

For the last remaining case, suppose that f does not lie on P and that the unique path R connecting f to

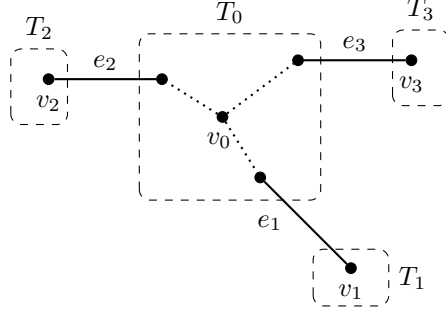

Figure 7: The situation from the proof of Lemma 12. Since e_1 , e_2 , and e_3 are pairwise compatible, no \mathcal{F} -edge can leave T_1 .

R meets P in an inner node v_i , $i \in \{2, \dots, s-1\}$. Here, R has the form $w_1 \xrightarrow{f} w_2 \rightarrow \dots \rightarrow w_t \rightarrow v_i$ and $\mathcal{A} \setminus \{e, f, g\}$ decomposes into four components: The component T_e contains v_1 , the component $T_{e,f,g}$ contains v_2, \dots, v_{s-1} and w_2, \dots, w_t , the component T_g contains v_s and the component T_f contains w_1 . The cuts $\delta_{\mathcal{F}}(T_f : T_g)$ and $\delta_{\mathcal{F}}(T_{e,f,g} : T_e)$ must be empty because e and f are compatible. The cuts $\delta_{\mathcal{F}}(T_f : T_e)$ and $\delta_{\mathcal{F}}(T_{e,f,g} : T_g)$ must be empty because f and g are compatible. Thus, the edges e and g are compatible. This concludes the proof. \square

We classify the edges in \mathcal{A} with respect to \mathcal{F} and \mathcal{T} . Recall that we assume $V[\mathcal{A}] = V[\mathcal{F}]$, and that \mathcal{A} is a tree, thus, it is a spanning tree on the vertices that we are interested in.

Definition 7. An edge $e \in \mathcal{A}$ is essential if \mathcal{A} is feasible with respect to \mathcal{T} , but $\mathcal{A} \setminus \{e\}$ is infeasible with respect to \mathcal{T} .

Definition 8. Let $e \in \mathcal{A}$ and let T_1, T_2 be the connected components of $\mathcal{A} \setminus \{e\}$. We say that e is safe if $\delta_{\mathcal{F}}(T_1) = \delta_{\mathcal{F}}(T_2) \neq \emptyset$, i.e., if at least one \mathcal{F} -edge crosses between T_1 and T_2 .

By definition, any essential edge is safe, however, the opposite is not true in general: Safe edges can be essential or inessential. We thus have classified the edges of \mathcal{A} into three classes: safe essential edges, safe inessential edges and unsafe (and ergo, inessential) edges.

Lemma 9. Let $e, f \in \mathcal{A}$ be two compatible edges. Then e is safe if and only if f is safe.

Proof. Suppose that e is safe and let $P = v_1 \xrightarrow{e} v_2 \rightarrow \dots \rightarrow v_{s-1} \xrightarrow{f} v_s$ be the unique path between e and f in \mathcal{A} . Let $T_e, T_{e,f}$ and T_f be the connected components of \mathcal{A} that contain the vertex v_1 , the vertices v_2, \dots, v_{s-1} and the vertex v_s , respectively. Since e and f are compatible we know that $\delta_{\mathcal{F}}(T_f : T_{e,f})$ is empty. Also, since e is safe, we have that $\delta_{\mathcal{F}}(T_e : T_f) = \delta_{\mathcal{F}}(T_f : T_e)$ is non-empty. It follows from $\delta_{\mathcal{F}}(T_f) = \delta_{\mathcal{F}}(T_f : T_e) \cup \delta_{\mathcal{F}}(T_f : T_{e,f})$ that f is safe. The reverse implication follows since e and f are exchangeable. \square

Lemma 10. Let $e, f \in \mathcal{A}$ be two unsafe edges. Then e and f are compatible.

Proof. Let $P = v_1 \xrightarrow{e} v_2 \rightarrow \dots \rightarrow v_{s-1} \xrightarrow{f} v_s$ be the unique path between e and f in \mathcal{A} . Let $T_e, T_{e,f}$ and T_f be the connected components of \mathcal{A} that contain the vertex v_1 , the vertices v_2, \dots, v_{s-1} and the vertex v_s , respectively. We need to show that $\delta_{\mathcal{F}}(T_e : T_{e,f}) = \delta_{\mathcal{F}}(T_f : T_{e,f}) = \emptyset$. Observe that $\delta_{\mathcal{F}}(T_e : T_{e,f}) \subseteq \delta_{\mathcal{F}}(T_e)$ and that $\delta_{\mathcal{F}}(T_f : T_{e,f}) \subseteq \delta_{\mathcal{F}}(T_f)$. The assumption that e and f are both unsafe implies that $\delta_{\mathcal{F}}(T_e) = \delta_{\mathcal{F}}(T_f) = \emptyset$ and we have thus shown the claim. \square

We have the following summary lemma showing that \sim_{cp} behaves well.

Lemma 11. *Let $e, f \in \mathcal{A}$ be compatible edges. Then*

1. *e is essential if and only if f is essential and*
2. *e is safe if and only if f is safe.*

Furthermore, if two edges $e, f \in \mathcal{A}$ are unsafe, then they are compatible. Thus, the set

$$S_u := \{e \in \mathcal{A} \mid e \text{ is unsafe}\}$$

forms an equivalence class of \sim_{cp} . If $S \in \mathfrak{S}$ is an equivalence class of \sim_{cp} , then either all edges $e \in S$ are essential or none. Also, if $S \neq S_u$, then all edges in S are safe.

Proof. We show Statement 1.

Statement 2 and the compatibility of unsafe edges are shown in Lemma 9 and Lemma 10. Let $P = v_1 \xrightarrow{e} v_2 \rightarrow \dots \rightarrow v_{s-1} \xrightarrow{f} v_s$ be the unique path between e and f in \mathcal{A} . Let $T_e, T_{e,f}$ and T_f be the connected components of \mathcal{A} that contain the vertex v_1 , the vertices v_2, \dots, v_{s-1} and the vertex v_s , respectively. Suppose that e is essential. We show that there must be a terminal pair u, \bar{u} with $u \in T_e \cup T_{e,f}$ and $\bar{u} \in T_f$. It then follows that $\mathcal{A} \setminus \{f\}$ is infeasible.

Since the edge e is essential, there must be a terminal pair u, \bar{u} with $u \in T_e$ and $\bar{u} \in T_{e,f} \cup T_f$. Since e and f are compatible, however, we know that $\delta_{\mathcal{F}}(T_e : T_{e,f}) = \delta_{\mathcal{F}}(T_f : T_{e,f}) = \emptyset$ which implies that $\delta_{\mathcal{F}}(T_{e,f}) = \emptyset$. Thus, if $\bar{u} \in T_{e,f}$, the forest \mathcal{F} would be infeasible. It follows that $\bar{u} \in T_f$ and thus, that f is essential. \square

We can now show that the compatibility classes in $\mathfrak{S} \setminus S_u$ behave as if they were single edges.

Lemma 12. *Let $K := \{e_1, \dots, e_l\} \subseteq \mathcal{A}$ with $l \geq 2$ be a set of pairwise compatible edges. Furthermore, suppose that $e_i \in K$ is safe for all $i = 1, \dots, l$. Then there is a path $P \subseteq \mathcal{A}$ with $K \subseteq P$.*

Proof. For $e, f \in K$ let $P_{e,f}$ be the unique path in \mathcal{A} starting with e and ending with f . Define $R := \bigcup_{e,f \in K} P_{e,f}$. Observe that $K \subseteq R \subseteq \mathcal{A}$ and that R is a tree whose leaves are all incident to edges in K . By contradiction assume R is not a path. Then there exists a vertex v_0 with $|\delta_R(v_0)| \geq 3$. In particular, there are three leaves v_1, v_2, v_3 of R such that the unique v_0 - v_i -paths in R for $i \in \{1, 2, 3\}$ are pairwise edge-disjoint. Let $e_1, e_2, e_3 \in K$ be the edges incident to v_1, v_2, v_3 in R , respectively. Let T_0, T_1, T_2, T_3 be the four components of $\mathcal{A} \setminus \{e_1, e_2, e_3\}$ with $v_i \in T_i$ for $i \in \{0, 1, 2, 3\}$, see Figure 7. Observe that $\delta_{\mathcal{F}}(T_1 : T_0 \cup T_3) = \delta_{\mathcal{F}}(T_1 : T_0 \cup T_2) = \emptyset$ because $e_1 \sim_{cp} e_2$ and $e_1 \sim_{cp} e_3$. We deduce that $\delta_{\mathcal{F}}(T_1) = \emptyset$, contradicting the fact that e_1 is safe. \square

Lemma 13. *Let $S \in \mathfrak{S}$ be an equivalence class of \sim_{cp} and let $e \in S$. Let $f \in \mathcal{F}$ such that $\mathcal{A} \setminus \{e\} \cup \{f\}$ is feasible. Then, $\mathcal{A} \setminus S' \cup \{f\}$ is feasible for all $S' \subseteq S$.*

Proof. If e is inessential, then all edges in S are inessential by Lemma 11. Thus, $\mathcal{A} \setminus S$ is feasible even without f and we are done. Otherwise, e is essential, which implies that all edges in S are essential by Lemma 11. So, they are also safe and we can apply 14(b) from Lemma 14. Let T_0, \dots, T_l be the connected components of $\mathcal{A} \setminus S$ in the order they are traversed by the path P containing S . Statement 14(b) implies that $\delta_{\mathcal{F}}(T_i) = \emptyset$ for all $i \in \{1, \dots, l-1\}$. Therefore, for every terminal pair $\{u, \bar{u}\} \in \mathfrak{T}$ there either is an $i \in \{0, \dots, l\}$ with $u, \bar{u} \in T_i$, or $u \in T_0$ and $\bar{u} \in T_l$ (w.l.o.g.). Hence the only terminal pairs that are disconnected by the removal of S are those with $u \in T_0$ and $\bar{u} \in T_l$. Statement 14(b) also implies that either $f \in \delta_{\mathcal{F}}(T_0 : T_l)$ or both endpoints of f are contained in one of the T_i . In the former case, $\mathcal{A} \setminus S \cup \{f\}$ is feasible since $T_0 \cup T_l$ is a connected component of this solution. In the latter case, the connected components of $\mathcal{A} \setminus \{e\} \cup \{f\}$ and $\mathcal{A} \setminus \{e\}$ are the same, which would imply that $\mathcal{A} \setminus \{e\}$ is feasible by our assumption, which is a contradiction to e being essential. \square

Lemma 14. Let $S \in \mathfrak{S} \setminus \{S_u\}$ be an equivalence class of safe edges. Let $f \in \mathcal{F}$ be an edge.

- a. Let $K \subseteq S$. Then there is a path $P \subseteq \mathcal{A}$ with $K \subseteq P$.
- b. Let $P \subseteq \mathcal{A}$ be the unique minimal path containing S and let T_0, \dots, T_l be the components of $\mathcal{A} \setminus S$ in the order they are traversed by P . Then either $f \in \delta_{\mathcal{F}}(T_0 : T_l)$, or there is an $i \in \{0, \dots, l\}$ such that T_i contains both endpoints of f .
- c. Let C be the unique cycle in $\mathcal{A} \cup \{f\}$. Then $S \subseteq C$ or $S \cap C = \emptyset$.
- d. If $\mathcal{A} \setminus \{e\} \cup \{f\}$ is feasible for some edge $e \in S$, then $\mathcal{A} \setminus S' \cup \{f\}$ is feasible for all $S' \subseteq S$. This also holds for $S = S_u$.

Proof. The proof of 14(a) is done in Lemma 12. For 14(b), denote the edges in S by e_1, \dots, e_l such that e_i is the edge between T_{i-1} and T_i for all $i \in \{1, \dots, l\}$. Since for any $i \neq j \in \{1, \dots, l\}$, the edges e_i and e_j are pairwise compatible, no \mathcal{F} -edge can cross between T_i and T_j , for any $i \neq j \in \{1, \dots, l\}$. Nor can there be \mathcal{F} -edges from T_0 to any T_i , for $i \in \{1, \dots, l\}$, since e_1 and e_{i+1} are compatible. Therefore either both endpoints of f lie within the same component T_i , or $f \in \delta_{\mathcal{F}}(T_0 : T_l)$.

Property 14(c) follows from 14(b) for $S \in \mathfrak{S} \setminus \{S_u\}$. Notice that for any $f \in \mathcal{F}$, all edges on C are automatically safe. Thus, the statement is true for S_u as well. Statement 14(d) is proven in Lemma 13. \square

The following fact is a straightforward generalization of Hall's theorem and an easy consequence of max flow/min cut (see, e.g., [CIM09]).

Fact 15. Let $G = (A \cup B, E)$ be a bipartite graph. For any $A' \subseteq A$, let $N(A') \subseteq B$ be the set of neighbors of the nodes in A' . If

$$\text{for all } A' \subseteq A : |N(A')| \geq |A'|/c$$

then there exists an assignment $\alpha : E \rightarrow \mathbb{R}_+$ such that $\sum_{e \in \delta(a)} \alpha(e) \geq 1$ for all $a \in A$ and $\sum_{e \in \delta(b)} \alpha(e) \leq c$ for all $b \in B$.

7 Proofs: Bounds on ϕ when the Local Optimum is a Tree

Let's recall (and formalize) some notation from §4.2. Let equivalence class $S \in \mathfrak{S} \setminus \{S_u\}$ of safe edges contain $\ell(S)$ edges. By Lemma 14(a), the edges of $S = \langle e_{S,1}, \dots, e_{S,\ell(S)} \rangle$ lie on a path: let

$$w_{S,0} \xrightarrow{e_{S,1}} v_{S,1} \rightarrow \dots \rightarrow w_{S,1} \xrightarrow{e_{S,2}} v_{S,2} \rightarrow \dots \rightarrow w_{S,i-1} \xrightarrow{e_{S,i}} v_{S,i} \rightarrow \dots \rightarrow w_{S,\ell(S)-1} \xrightarrow{e_{S,\ell(S)}} v_{S,\ell(S)}$$

be this path, where each $e_{S,i} = \{w_{S,i-1}, v_{S,i}\}$. When the context is clear (as it is in this subsection), we use $e_1, \dots, e_{\ell(S)}$ and $v_1, \dots, v_{\ell(S)}, w_0, \dots, w_{\ell(S)-1}$ instead. Notice that $w_{S,i} = v_{S,i}$ is possible, but we always have $w_{S,i-1} \neq v_{S,i}$.

Removing S decomposes \mathcal{A} into $\ell(S) + 1$ connected components. Let the connected component containing w_i be $(V_{S,i}, E_{S,i})$ and the connected component that contains $v_{\ell(S)}$ be $(V_{S,\ell(S)}, E_{S,i})$. As in the rest of the paper, we will associate each components by its edge set. We think of $E_{S,0}, E_{S,\ell(S)}$ as the *outside* of the path that S lies on, and $E_{S,1}, \dots, E_{S,\ell(S)-1}$ as the *inner* components. Note that these components form vertex-disjoint subtrees of \mathcal{A} .

Observation 16. Let $S \in \mathfrak{S} \setminus \{S_u\}$ and $i, i' \in \{0, \dots, \ell(S)\}$, $i \neq i'$. Then $E_{S,i} \cap E_{S,i'} = \emptyset$. Also, \mathcal{A} is the disjoint union of $E_{S,0}, \dots, E_{S,\ell(S)}$ and S .

Next, we set $m(S)$ and $n(S)$ to be the index of the inner components with the largest and second-largest widths, respectively. (We use the indexing index from §2 to break ties, so $m(S) := \arg \max_{i=1, \dots, \ell(S)-1} \text{index}(E_{S,i})$, and $n(S) := \arg \max_{i \in \{1, \dots, \ell(S)-1\} \setminus \{m(S)\}} \text{index}(E_{S,i})$.) Without loss of generality, we assume that the orientation of the path is such that $m(S) < n(S)$. Let $\text{In}_S := \{1, 2, \dots, \ell(S) - 1\}$ be the indices of the inner components, and $\text{In}_{S'} := \text{In}_S \setminus \{m(S), n(S)\}$. Now we split the cost of the solution \mathcal{A} into three terms. It holds that

$$\begin{aligned} \phi(\mathcal{A}) &= w(\mathcal{A}) + \sum_{e \in \mathcal{A}} d_f = w(\mathcal{A}) + \sum_{e \in S_u} d_e + \sum_{S \in \mathfrak{G} \setminus \{S_u\}} \sum_{e \in S} d_e \\ &= \left(w(\mathcal{A}) + \sum_{e \in S_u} d_e \right) + \left(\sum_{S \in \mathfrak{G} \setminus \{S_u\}} \left(\sum_{i=1}^{\ell(S)} d_{e_i} - \sum_{i \in \text{In}_S} w(E_{S,i}) \right) \right) \\ &\quad + \left(\sum_{S \in \mathfrak{G} \setminus \{S_u\}} \sum_{i \in \text{In}_S} w(E_{S,i}) \right). \end{aligned}$$

7.1 Bounding the Middle Term

The next lemma and the corollary bound the cost of the middle term.

Lemma 17. *Let $I = (V, E, \mathfrak{T}, d)$ be a Steiner Forest instance and let \mathcal{F} be a feasible solution for I . Furthermore, let $\mathcal{A} \subseteq E$ be a feasible tree solution for I that is edge/set swap-optimal with respect to \mathcal{F} and ϕ . Set $S \in \mathfrak{G} \setminus \{S_u\}$ be an equivalence class of safe edges. Let $f \in \mathcal{F}$ be an edge that closes a cycle in \mathcal{A} that contains S . Then*

$$d_f \geq \frac{1}{3} \left(\sum_{i=1}^{\ell(S)} d_{e_i} - \sum_{i \in \text{In}_S} w_i \right).$$

Proof. Since f closes a cycle in \mathcal{A} that contains S , any edge e in S satisfies that $\mathcal{A} \setminus \{e\} \cup \{f\}$ is feasible. By Lemma 14(d), this implies that $\mathcal{A} \setminus S \cup \{f\}$ is feasible as well. Thus, adding f and removing any subset $S' \subseteq S$ is a feasible edge/set swap. We consider three subsets $S'_1 := \{e_1, \dots, e_{m(S)}\}$, $S'_2 := \{e_{m(S)+1}, \dots, e_{n(S)}\}$ and $S'_3 := \{e_{n(S)+1}, \dots, e_{\ell(S)}\}$. Since \mathcal{A} is edge/set swap-optimal with respect to \mathcal{F} and ϕ , we know that adding f and removing S'_1 , S'_2 or S'_3 is not an improving swap. When adding f , we pay d_f . When removing S'_1 , we gain $\sum_{i=1}^{m(S)} d_{e_i}$, but we have to pay the width of the connected components that we create. Notice that we detach the connected components $E_{S,1}, \dots, E_{S,m(S)-1}$ from the tree. Since $E_{S,m(S)}$ has the maximum width on the path, the increase in ϕ that originates from widths has to be $\sum_{i=1}^{m(S)-1} w(E_{S,i})$. Thus, the fact that the swap is not improving yields that

$$d_f + \sum_{i=1}^{m(S)-1} w(E_{S,i}) \geq \sum_{i=1}^{m(S)} d_{e_i} \Leftrightarrow d_f \geq \sum_{i=1}^{m(S)} d_{e_i} - \sum_{i=1}^{m(S)-1} w(E_{S,i})$$

Similarly, we gain that

$$d_f \geq \sum_{i=m(S)+1}^{n(S)} d_{e_i} - \sum_{i=m(S)+1}^{n(S)-1} w(E_{S,i}) \quad \text{and} \quad d_f \geq \sum_{i=n(S)+1}^{\ell(S)} d_{e_i} - \sum_{i=n(S)}^{\ell(S)-1} w(E_{S,i})$$

from the fact that (f, S'_2) and (f, S'_3) are not improving. The statement of the lemma follows by adding the inequalities and dividing the resulting inequality by three. \square

Corollary 18. *Let $I = (V, E, \mathfrak{T}, d)$ be a Steiner Forest instance and let \mathcal{F} be a feasible solution for I . Furthermore, let $\mathcal{A} \subseteq E$ be a feasible tree solution for I that is edge/edge and edge/set swap-optimal with*

respect to \mathcal{F} and ϕ . Then,

$$\sum_{S \in \mathfrak{G} \setminus \{S_u\}} \left(\sum_{i=1}^{\ell(S)} d_{e_i} - \sum_{i \in \text{In}_S} w(E_{S,i}) \right) \leq 10.5 \cdot \sum_{e \in \mathcal{F}} d_e.$$

Proof. We set $\Delta(S) := \frac{1}{3} \left(\sum_{i=1}^{\ell(S)} d_{e_i} - \sum_{i \in \text{In}_S} w(E_{S,i}) \right)$. The corollary then follows by Lemma 17 and Theorem 3. \square

7.2 Bounding the First Term

The following lemma bounds the first term of the cost.

Lemma 19. *Let $I = (V, E, \mathfrak{T}, d)$ be a Steiner Forest instance and let \mathcal{F} be a feasible solution for I with $cc(\mathcal{F})$ connected components $F_1, \dots, F_{cc(\mathcal{F})}$. Furthermore, let $\mathcal{A} \subseteq E$ be a feasible tree solution for I and recall that S_u is the equivalence class of unsafe edges in \mathcal{A} . Assume that \mathcal{A} is removing swap-optimal. It holds that*

$$w(\mathcal{A}) + \sum_{e \in S_u} d_e \leq \sum_{i=1}^{cc(\mathcal{F})} w(F_i).$$

Proof. $\mathcal{A} \setminus S_u$ contains $|S_u| + 1$ connected components $E_1, \dots, E_{|S_u|+1}$, number them by decreasing width, i.e., $w(E_1) \geq w(E_2) \geq \dots \geq w(E_{|S_u|+1})$. Since \mathcal{F} does not connect them by definition of S_u , its number of connected components satisfies $cc(\mathcal{F}) \geq |S_u| + 1$. Furthermore, any component E_i contains a component F_j with $w(F_j) = w(E_i)$. Assume that the components are numbered such that $w(F_i) = w(E_i)$ for $i = 1, \dots, |S_u| + 1$.

Consider the removing swap that removes all edges in S_u . Before the swap, \mathcal{A} paid all edges and $w(\mathcal{A})$. After the swap, \mathcal{A} would pay all edges except those in S_u plus $\sum_{i=1}^{|S_u|+1} w(E_i) = \sum_{i=1}^{|S_u|+1} w(F_i)$. Since the swap was not improving, we know that

$$w(\mathcal{A}) + \sum_{e \in \mathcal{A}} d_e \leq \sum_{i=1}^{|S_u|+1} w(F_i) + \sum_{e \in \mathcal{A}} d_e - \sum_{e \in S_u} d_e.$$

Thus, $w(\mathcal{A}) + \sum_{e \in S_u} d_e \leq \sum_{i=1}^{|S_u|+1} w(F_i) \leq \sum_{i=1}^{cc(\mathcal{F})} w(F_i)$. \square

7.3 Bounding the Third Term: Sum of Widths

For the third term, we need a bit more work. The main step is to show that $\text{in}\partial\text{er}(E_{S,i})$ is an injective function of S, i when restricting to $i \in \text{In}_S$. The following lemma helps to prove this statement.

Lemma 20. *Let $S, S' \in \mathfrak{G} \setminus \{S_u\}$ with $S \neq S'$. Exactly one of the following two cases holds:*

- $S' \subseteq E_{S,0} \cup E_{S,\ell(S)}$, i.e., S' lies in the outside of the path of S
- There exists $i \in \{1, \dots, \ell(S) - 1\}$ with $S' \subseteq E_{S,i}$.

Proof. Notice that $S \cap S' = \emptyset$ by definition because S and S' are different equivalence classes. Let $e', f' \in S'$, i.e., $e', f' \notin S$. Assume that $e' \in E_{S,i}$ for an $i \in \{1, \dots, \ell(S) - 1\}$, but $f' \notin E_{S,i}$. Following the notation on page 15, we denote the unique edges in S that touch $E_{S,i}$ by $e_{S,i}$ and $e_{S,i+1}$ and their adjacent vertices in $E_{S,i}$ by v_i and w_i . Removing $e_{S,i}$ and $e_{S,i+1}$ creates three connected components in \mathcal{A} . The first component contains $E_{S,0}, \dots, E_{S,i-1}$ and the edges $e_{S,1}, \dots, e_{S,i-1}$ and we name it $E_{S,<}$. The second

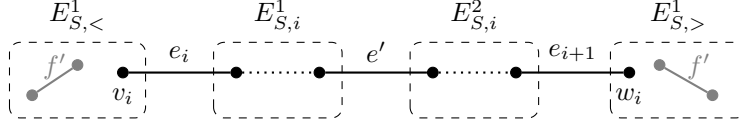

(a) First case: Removing e' disconnects v_i and w_i . Thus, e_i , e' and e_{i+1} lie on a path. No \mathcal{F} -edge can leave $E_{S,i} = E_{S,i}^1 \cup E_{S,i}^2$. Also, no \mathcal{F} -edge can go between $E_{S,i}^1$ and $E_{S,i}^2$ since e' and f' are compatible. Thus, e' is compatible to e_i and e_{i+1} .

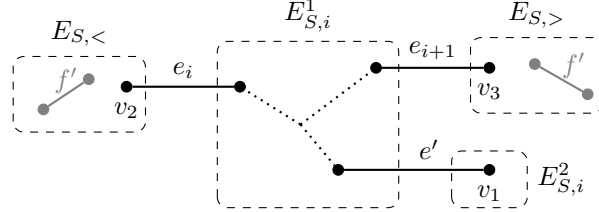

(b) Second case: The nodes v_i and w_i lie in the same connected component when removing e' . Again, no \mathcal{F} -edge can leave $E_{S,i}$. Also, no edge can go between $E_{S,i}^1$ and $E_{S,i}^2$ because e' and f' are compatible. Thus, e' is compatible to e_i and e_{i+1} .

Figure 8: Two cases that occur in Lemma 20.

component is $E_{S,i}$. The third component contains $E_{S,i+1}, \dots, E_{S,\ell(S)}$ and the edges $e_{S,i+1}, \dots, e_{S,\ell(S)}$ and we name it $E_{S,>}$. Since $f' \notin E_{S,i}$, and $f' \notin S$, we know that $f' \in E_{S,<} \cup E_{S,>}$.

Notice that e' and f' are compatible, $e_{S,i}$ and $e_{S,i+1}$ are compatible, but e' is not compatible to either $e_{S,i}$ or $e_{S,i+1}$. If we remove e' in addition to $e_{S,i}$ and $e_{S,i+1}$, then $E_{S,i}$ decomposes into two connected components, $E_{S,i}^1$ and $E_{S,i}^2$. We assume without loss of generality that $v_{S,i} \in E_{S,i}^1$. The vertex $w_{S,i}$ can either be separated from $v_{S,i}$ when removing e' , i.e., $w_{S,i} \in E_{S,i}^2$, or not, i.e., $w_{S,i} \in E_{S,i}^1$. The two cases are depicted in Figure 8.

If $w_{S,i} \in E_{S,i}^2$, then the edges $e_{S,i}$, e' and $e_{S,i+1}$ lie on a path. No \mathcal{F} -edge can leave $E_{S,i} = E_{S,i}^1 \cup E_{S,i}^2$ because $e_{S,i}$ and $e_{S,i+1}$ are compatible. Thus, any \mathcal{F} -edge leaving $E_{S,i}^1$ has to end in $E_{S,i}^2$. On the other hand, consider removing e' and f' from \mathcal{A} , which creates three components $T_{e'}$, $T_{e',f'}$, $T_{f'}$. As both $E_{S,i}^1$ and $E_{S,i}^2$ are incident to e' , they are contained in two different components, $T_{e'}$ and $T_{e',f'}$. Since no edge can leave $T_{e',f'}$ because e' and f' are compatible, no edge can cross between $E_{S,i}^1$ and $E_{S,i}^2$. Thus, no \mathcal{F} -edges leave $E_{S,i}^1$ or $E_{S,i}^2$, which means that e' is compatible to $e_{S,i}$ and $e_{S,i+1}$.

If $w_{S,i} \in E_{S,i}^1$, the argument is similar. Still, no \mathcal{F} -edge can leave $E_{S,i} = E_{S,i}^1 \cup E_{S,i}^2$ because $e_{S,i}$ and $e_{S,i+1}$ are compatible. Also, $E_{S,i}^1 \subseteq T_{e',f'}$ and $E_{S,i}^2 \subseteq T_{e'}$ still are in different connected components when e' and f' are removed. Thus, no \mathcal{F} -edge can connect them, and thus e' is compatible to $e_{S,i}$ and $e_{S,i+1}$.

Both cases end in a contradiction since e' cannot be compatible to any edge in S because S and S' are different equivalence classes. Thus, $e' \in E_{S,i}$ implies that $S \subseteq E_{S,i}$. Only if no edge in S' lies in any $E_{S,i}$ for $i \in \{1, \dots, \ell(S) - 1\}$, then it is possible that edges of S' lie in $E_{S,0}$ or $E_{S,\ell(S)}$. However, then $S' \subseteq (E_{S,0} \cup E_{S,\ell(S)})$. \square

We set $\mu(S, i) = \text{ind}\mathcal{E}\mathcal{F}(E_{S,i})$ for all $S \in \mathfrak{S} \setminus \{S_u\}$ and $i \in \text{In}_S$.

Lemma 21. *Let $S, S' \in \mathfrak{S} \setminus \{S_u\}$, $i \in \text{In}_S$, $i' \in \text{In}_{S'}$. Then*

$$\mu(S, i) = \mu(S', i') \Rightarrow S = S' \text{ and } i = i',$$

i.e., the mapping μ is injective.

Proof. Let $\mu(S, i) = \mu(S', i')$ and denote by $u^* := u_{\mu(S, i)} = u_{\text{index}(E_{S, i})}$ and $\bar{u}^* := \bar{u}_{\mu(S, i)} = \bar{u}_{\text{index}(E_{S, i})}$ the corresponding terminal pair. By the definition of index , it follows that $u^*, \bar{u}^* \in V_{S, i} \cap V_{S', i'}$ and in particular, we know that $V_{S, i} \cap V_{S', i'} \neq \emptyset$. If $S = S'$, then either $i = i'$ (and we are done) or $i \neq i'$ implies that $V_{S, i} \cap V_{S', i'} = \emptyset$ which is a contradiction. Thus, assume in the following that $S \neq S'$.

Let P be the unique u^* - $v_{S, i}$ -path in $E_{S, i}$. If $P \cap S' = \emptyset$, then $P \subseteq E_{S', i'}$ because $u^* \in V_{S', i'}$. Thus, $v_{S, i} \in V_{S', i'}$, which also implies that $e_{S, i} \in E_{S', i'}$. By Lemma 20, we get $S \subseteq E_{S', i'}$. On the other hand, if $P \cap S' \neq \emptyset$, then $S' \subseteq E_{S, i}$ by Lemma 20. Thus $S \subseteq E_{S', i'}$ or $S' \subseteq E_{S, i}$. W.l.o.g., we assume the latter. Now let $j \in \{\mathfrak{m}(S'), \mathfrak{n}(S')\}$ be such that $E_{S', j} \cap S = \emptyset$ (note that j exists due to Lemma 20). Because $e_{S', j}, e_{S', j+1} \in S' \subseteq E_{S, i}$ and $E_{S', j} \cap S = \emptyset$, we deduce that $E_{S', j} \subseteq E_{S, i}$. This implies that $\mu(S, i) \geq \text{index}(E_{S', j}) > \mu(S', i')$, again a contradiction. \square

We can now bound the third term of our objective function (see page 16).

Lemma 22. *As previously, let \mathfrak{S} denote the set of all equivalence classes of the compatibility relation \sim_{cp} , let \mathcal{A} be a feasible tree and denote by $E_{S, i}$ the i -th inner connected component on the path that contains $S \in \mathfrak{S} \setminus \{S_u\}$. Let \mathcal{F} be a feasible Steiner Forest with $cc(\mathcal{F})$ connected components $F_1, \dots, F_{cc(\mathcal{F})}$. Then,*

$$\sum_{S \in \mathfrak{S} \setminus \{S_u\}} \sum_{i \in \text{In}_S} w(E_{S, i}) \leq \sum_{i=1}^{cc(\mathcal{F})} w(F_i)$$

Proof. As previously, we set $\mu(S, i) = \text{index}(E_{S, i})$ for all $S \in \mathfrak{S} \setminus \{S_u\}$ and $i \in \text{In}_S$. We also recall that by definition, $w(E_{S, i}) = d_G(u_{\text{index}(S, i)}, \bar{u}_{\text{index}(S, i)}) = d_G(u_{\mu(S, i)}, \bar{u}_{\mu(S, i)})$ for all $S \in \mathfrak{S} \setminus \{S_u\}$ and all $i \in \text{In}_S$. We thus have

$$\sum_{S \in \mathfrak{S} \setminus \{S_u\}} \sum_{i \in \text{In}_S} w(E_{S, i}) = \sum_{S \in \mathfrak{S} \setminus \{S_u\}} \sum_{i \in \text{In}_S} d_G(u_{\mu(S, i)}, \bar{u}_{\mu(S, i)}). \quad (1)$$

Let $\chi(S, i)$ denote the index of the connected component $F_{\chi(S, i)}$ containing the terminal pair $u_{\text{index}(S, i)}, \bar{u}_{\text{index}(S, i)}$ in \mathcal{F} . We claim that χ is injective. To see this, consider $S, S' \in \mathfrak{S}$ and $i \in \text{In}_S, i' \in \text{In}_{S'}$ with $\chi(S, i) = \chi(S', i')$. Since $\delta_{\mathcal{F}}(V_{S, i}) = \delta_{\mathcal{F}}(V_{S', i'}) = \emptyset$ and $F_{\chi(S, i)}$ is connected, we deduce that $V[F_{\chi(S, i)}] \subseteq V_{S, i} \cap V_{S', i'}$. This implies that $u_{\mu(S, i)}, \bar{u}_{\mu(S, i)} \in V_{S', i'}$ and that $u_{\mu(S', i')}, \bar{u}_{\mu(S', i')} \in V_{S, i}$. Hence $\mu(S, i) = \mu(S', i')$, which implies $S = S'$ and $i = i'$ by Lemma 21.

Since $d_G(u_{\mu(S, i)}, \bar{u}_{\mu(S, i)}) \leq w(F_{\chi(S, i)})$, we can now continue (1) to see that

$$\sum_{S \in \mathfrak{S} \setminus \{S_u\}} \sum_{i \in \text{In}_S} d_G(u_{\mu(S, i)}, \bar{u}_{\mu(S, i)}) \leq \sum_{S \in \mathfrak{S} \setminus \{S_u\}} \sum_{i \in \text{In}_S} w(F_{\chi(S, i)}) \leq \sum_{i=1}^{cc(\mathcal{F})} w(F_i).$$

Here, the last inequality follows from our argument that χ is injective. \square

7.3.1 Wrapping Things Up

We can now prove the main result of this section.

Theorem 23. *Let $G = (V, E)$ be a graph, let d_e be the cost of edge $e \in E$ and let $\mathfrak{T} \subseteq V \times V$ be a terminal set. Let $\mathcal{A}, \mathcal{F} \subseteq E$ be two feasible solutions for (G, d, \mathfrak{T}) with $V[\mathcal{A}] = V[\mathcal{F}]$. Furthermore, suppose that \mathcal{A} is a tree and that \mathcal{A} is edge/set swap optimal with respect to \mathcal{F} and ϕ . Then,*

$$\phi(\mathcal{A}) = \sum_{e \in \mathcal{A}} d_e + w(\mathcal{A}) \leq 10.5 \cdot d(\mathcal{F}) + w(\mathcal{F}) + \sum_{e \in S_u} d_e + w(\mathcal{A}).$$

In particular, $d(\mathcal{A}) \leq 10.5 \cdot d(\mathcal{F}) + w(\mathcal{F}) + \sum_{e \in S_u} d_e$.

Proof. Rewrite $\phi(\mathcal{A})$ as on page 16 to

$$\phi(\mathcal{A}) = w(\mathcal{A}) + \sum_{e \in S_u} d_e + \underbrace{\sum_{S \in \mathcal{S} \setminus \{S_u\}} \left(\sum_{i=1}^{\ell(S)} d_{e_i} - \sum_{i \in \text{In}_S} w(E_{S,i}) \right)}_{\leq 10.5 \cdot d(\mathcal{F}) \text{ by Corollary 18}} + \underbrace{\sum_{S \in \mathcal{S} \setminus \{S_u\}} \sum_{i \in \text{In}_S} w(E_{S,i})}_{\leq w(\mathcal{F}) \text{ by Lemma 22}}.$$

This proves the theorem. \square

Additionally applying Lemma 19 yields the following reformulation of Theorem 23.

Corollary 24. *Let $G = (V, E)$ be a graph, let d_e be the cost of edge $e \in E$ and let $\mathfrak{T} \subseteq V \times V$ be a terminal set. Let $\mathcal{A}, \mathcal{F} \subseteq E$ be two feasible solutions for (G, d, \mathfrak{T}) with $V[\mathcal{A}] = V[\mathcal{F}]$. Furthermore, suppose that \mathcal{A} is a tree and that \mathcal{A} is optimal with respect to \mathcal{F} and ϕ under edge/edge, edge/set and removing swaps. Then,*

$$\phi(\mathcal{A}) \leq 10.5 \cdot d(\mathcal{F}) + w(\mathcal{F}) + \sum_{e \in S_u} d_e + w(\mathcal{A}) \leq 10.5 \cdot d(\mathcal{F}) + 2w(\mathcal{F}) \leq 10.5 \cdot \phi(\mathcal{F}) \quad \square$$

If we want to bound the original objective function of the Steiner Forest problem, we do not need removing swaps.

Corollary 2. *Let $G = (V, E)$ be a graph, let d_e be the cost of edge $e \in E$ and let $\mathfrak{T} \subseteq V \times V$ be a set of terminal pairs. Let $\mathcal{A}, \mathcal{F} \subseteq E$ be two feasible Steiner forests for (G, d, \mathfrak{T}) with $V[\mathcal{A}] = V[\mathcal{F}]$. Assume that \mathcal{A} is a tree and that \mathcal{A} is swap-optimal with respect to \mathcal{F} and ϕ under edge/edge and edge/set swaps. Denote by \mathcal{A}' the modified solution where all inessential edges have been dropped from \mathcal{A} . Then,*

$$d(\mathcal{A}') \leq 10.5 \cdot d(\mathcal{F}) + w(\mathcal{F}) \leq 11.5 \cdot d(\mathcal{F}).$$

Proof. Let S_{is} be the set of safe but inessential edges. We have $d(\mathcal{A}) \leq 10.5 \cdot d(\mathcal{F}) + w(\mathcal{F}) + \sum_{e \in S_u} d_e$ by Theorem 23. That implies

$$\sum_{e \in \mathcal{A}'} d_e = d(\mathcal{A}) - \sum_{e \in S_u} d_e - \sum_{e \in S_{is}} d_e \leq 10.5 \cdot d(\mathcal{F}) + w(\mathcal{F}) - \sum_{e \in S_{is}} d_e. \quad \square$$

8 Proofs: Bounds when the Local Optimum is a Forest

The aim of this section is to transform (a.k.a. “project”) a pair $(\mathcal{A}, \mathcal{F})$ of arbitrary solutions into a pair $(\mathcal{A}, \mathcal{F}')$ of solutions to which the results from the previous section apply. I.e., each connected component of \mathcal{F}' is contained within a connected component of \mathcal{A} . The main lemma is

Lemma 36. *Let $G = (V, E)$ be a complete graph, let $d : E \rightarrow \mathbb{R}_{\geq 0}$ be a metric that assigns a cost d_e to every edge $e \in E$ and let $\mathfrak{T} \subseteq V \times V$ be a set of terminal pairs. Let $\mathcal{A}, \mathcal{F} \subseteq E$ be two feasible Steiner Forest solutions for (G, \mathfrak{T}) . Furthermore, suppose that \mathcal{A} is edge/edge, edge/set and path/set swap-optimal with respect to E and ϕ , that \mathcal{A} is c -approximate connecting move optimal and that \mathcal{A} only uses edges between terminals. Then there exists a feasible solution \mathcal{F}' with $d(\mathcal{F}') \leq 2(1+c) \cdot d(\mathcal{F})$ that satisfies $\mathcal{F}' = \mathcal{F}'_{\circ}$ such that \mathcal{A} is edge/edge and edge/set swap-optimal with respect to \mathcal{F}' .*

We use the notation \mathcal{F}_{\circ} to denote the set of edges in \mathcal{F} that go within components of \mathcal{A} and $\mathcal{F}_{\leftrightarrow}$ to denote the set of all edges between different components, and c is the approximation guarantee of the approximate connecting moves. Formally, c -approximate tree move optimality is defined as follows:

Definition 25. A c -approximate connecting move for some constant $c \geq 1$ is a connecting move $\text{conn}(T)$ applied to the current solution \mathcal{A} using a tree T in $G_{\mathcal{A}}^{\text{all}}$ such that $c \cdot d(T) \leq \bar{w}(\mathcal{A}) - \bar{w}(\mathcal{A} \cup T)$. A solution is c -approximate connecting move optimal, if there are no c -approximate connecting moves.

Lemma 36 shows that for any solution \mathcal{F} , we can find a solution \mathcal{F}' with

$$d(\mathcal{F}') \leq 2(1 + c) \cdot d(\mathcal{F})$$

which does not contain edges between different components of \mathcal{A} , i.e., $\mathcal{F}'_{\circlearrowleft} = \mathcal{F}'$. With Section B.2, we know that c is at most 2, i.e., we can find \mathcal{F}' with $d(\mathcal{F}') \leq 6 \cdot d(\mathcal{F})$. Every connected component A_j of \mathcal{A} can now be treated separately by using Corollary 2 on A_j and the part of \mathcal{F}' that falls into A_j . By combining the conclusions for all connected components, we get that

$$d(\mathcal{A}') \leq 11.5 \cdot d(\mathcal{F}') \leq 23(1 + c) \cdot d(\mathcal{F}) \leq 69 \cdot d(\mathcal{F})$$

for any feasible solution \mathcal{F} . This proves the main theorem.

Theorem 1. *There is a (non-oblivious) local search algorithm for Steiner Forest with a constant locality gap. It can be implemented to run in polynomial time.*

Proof outline The forest case depends on path/set swaps and connecting moves. Exploiting connecting move-optimality is the main effort of the section, while path/set swap-optimality is only used to handle one specific situation.

The goal is to replace $\mathcal{F}_{\leftrightarrow}$ by edges that go within components of \mathcal{A} .

We first convert \mathcal{F} into a collection of disjoint cycles at the expense of a factor of 2 in the edge costs. Let F_i be one of the cycles. We want to replace $(F_i)_{\leftrightarrow}$. To do so, we look at F_i in $G_{\mathcal{A}}$ – the graph where the edges in $\mathcal{F}_{\circlearrowleft}$ are contracted and loops are removed. In this graph $G_{\mathcal{A}}$, the set $(F_i)_{\leftrightarrow}$ is a circuit (i.e., a possibly non-simple cycle). In a first step, we use Algorithm 1 to cope with the case that $(F_i)_{\leftrightarrow}$ has a special structure that we call *minimally guarded*. The second step inductively ensures that this structure is present.

An example run of Algorithm 1 is visualized in Figure 12. The algorithm partitions $(F_i)_{\leftrightarrow}$ into trees in $G_{\mathcal{A}}$. These trees define connecting moves, so (approximate) connecting move-optimality gives us a lower bound on the total edge weight of each tree.

Let n_j be the number of times that F_i passes through A_j , the j -th connected component of \mathcal{A} . Then the lower bound that we get is

$$d((F_i)_{\leftrightarrow}) \geq \left(\sum_{j=1}^p n_j w(A_j) \right) - n_{j_m} w(A_{j_m}).$$

Here, j_m is the component with the largest width among all components that F_i touches. In a minimally guarded circuit, this component is only visited once. The lower bound (for minimally guarded circuits) results from Lemma 29 and Corollary 34 (notice that n_j is defined differently in the actual proof, but we need less detail here). The part between the two statements establishes invariants of Algorithm 1 that we need to show that it computes trees with the correct properties.

The lower bound means that we can do the following. Assume that we delete $(F_i)_{\leftrightarrow}$. Now some vertices in \mathcal{A} do no longer have adjacent \mathcal{F} -edges which is a problem for applying Corollary 2. We fix this by inserting a direct connection to their terminal partner, which has to be in the same component of \mathcal{A} . In order to keep the modified solution feasible, we insert the new connections a bit differently, but with the same result. This

connection is paid for by $(F_i)_{\leftrightarrow}$ which – due to our construction – can give each of these vertices a budget equivalent to the width of its component. This enables us to use the results from the tree case.

This argument does not work for the vertices in the largest-width component. If F_i is minimally guarded, it visits the largest width component exactly once and there are exactly two problematic vertices. To reconnect these vertices, we use path/set swap-optimality and charge $(F_i)_{\leftrightarrow}$ again to pay for directly connecting them (this argument comes later, in the proof of Lemma 35, when Corollary 34 is applied).

If otherwise F_i is not minimally guarded, we need a second step. This is taken care of in Lemma 35 which extends Corollary 34 to *guarded* circuits that are not necessarily minimal. This is done by applying Corollary 34 to subcircuits and removing these until the minimality criterion is met. The proof is by induction. Lemma 35 outputs a broken solution \mathcal{F}' which is not feasible, but is equipped with the widths from the lower bound. Figures 13 up to 21 show the recursive process for an example circuit and visualize the broken solution that comes out of it. The solution is then repaired in Lemma 36, giving the final reduction result.

8.1 Details: Getting a Good Tree Packing

While the previous sections operated on arbitrary graphs, we now consider the metric case of the Steiner forest problem. Consequently, we assume that $G = (V, E)$ is the complete graph on V and that the cost $d_e = d_{vw}$ of each edge $e = \{v, w\} \in E$ is given by a metric $d : V \times V \rightarrow \mathbb{R}_{\geq 0}$. Together with a set of terminal pairs $\mathfrak{T} \subseteq V$, the graph G and the metric d define an instance of the metric Steiner Forest problem.

The more important change in our setting is, however, that we no longer assume that our feasible solution $\mathcal{A} \subseteq E$ is a tree; rather, \mathcal{A} can be an arbitrary feasible forest in G . We write its connected components as $A_1, \dots, A_p \subseteq \mathcal{A}$, where the numbering is fixed and such that $w(A_1) \leq w(A_2) \leq \dots \leq w(A_p)$ holds. As in the previous sections, we compare \mathcal{A} to another solution \mathcal{F} .

The connected components of \mathcal{A} are trees and it is a natural idea to apply the results from the previous sections to these trees by considering each connected component of \mathcal{A} individually. Morally, the main obstacle in doing so is the following: In the proof of Theorem 3, we assume implicitly that no \mathcal{F} -edge crosses between connected components of \mathcal{A} .[¶] This is vacuously true in the case where \mathcal{A} is a tree; however, if \mathcal{A} is a forest, this assumption is not justified in general. In the following, our underlying idea is to replace \mathcal{F} -edges that cross between the components of \mathcal{A} by edges that lie within the components of \mathcal{A} , thereby re-establishing the preconditions of Theorem 3. We show how to do this such that \mathcal{F} stays feasible and such that its cost is increased by at most a constant factor.

8.1.1 Notation

We start with some normalizing assumptions on \mathcal{F} . As before, we denote the connected components of \mathcal{F} by $F_1, \dots, F_q \subseteq \mathcal{F}$. First we can assume that each F_i has no inessential edges. Then, since we are in the metric case, we can convert each F_i into a simple cycle—this can be done with at most a factor 2 loss in the cost of \mathcal{F} by taking an Euler tour and short-cutting over repeated vertices and non-terminals. This implies that $V[\mathcal{F}] \subseteq V[\mathcal{A}]$, since now \mathcal{F} only has terminals, which are all covered by \mathcal{A} . Assume that $V[\mathcal{A}]$ only contains terminals. Then, $V[\mathcal{F}]$ and $V[\mathcal{A}]$ are equal. Recall that \mathfrak{T} is the set of terminal pairs, let $V_{\mathfrak{T}}$ be the set of all terminals. Henceforth, we assume that $V = V[\mathcal{F}] = V[\mathcal{A}] = V_{\mathfrak{T}}$.

Observation 26. *Let \mathcal{F}, \mathcal{A} be feasible solutions and assume that $V[\mathcal{A}] = V_{\mathfrak{T}}$. Then there exists a solution \mathcal{F}' of cost $2 \cdot \sum_{e \in \mathcal{F}} d_e + \sum_{i=1}^q w(F_i)$ whose connected components are node disjoint cycles and which satisfies $V[\mathcal{F}'] = V[\mathcal{A}] = V_{\mathfrak{T}}$.*

[¶]More precisely, we need the slightly weaker condition that for each node $t \in V[\mathcal{A}]$, there is an \mathcal{F} -edge incident to t that does not leave the connected component of \mathcal{A} containing t .

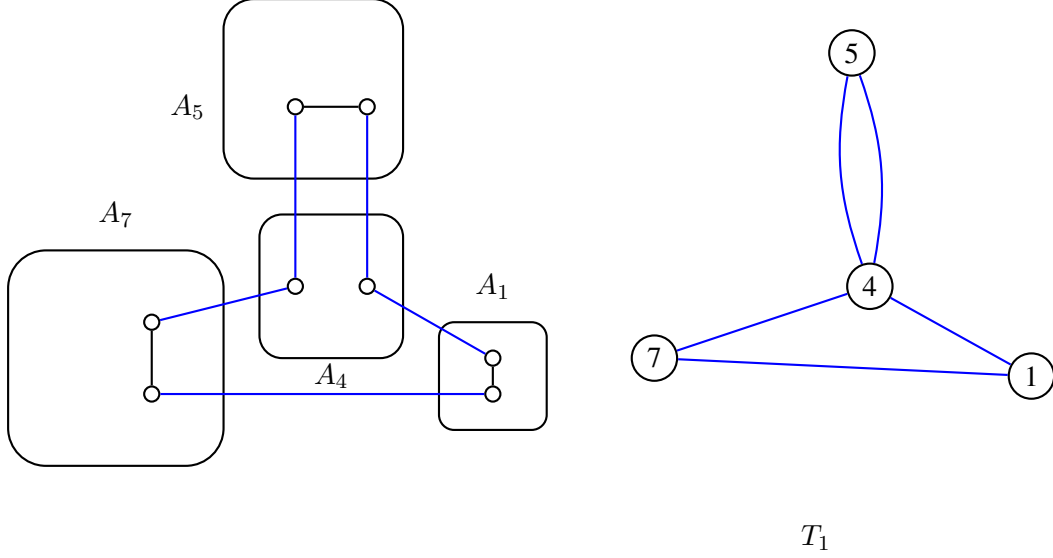

Figure 9: A simple cycle F_i in G (depicted in blue and black) that induces the blue circuit C_i in $G_{\mathcal{A}}$. Notice that C_i is not simple. The rounded rectangles represent connected components of \mathcal{A} , and their size indicates their width.

Next, we define a convenient notation for the connected components of \mathcal{A} and the \mathcal{F} -cycles that pass through them. For each $v \in V$, we set $\xi(v) = j$ for the unique $j \in \{1, \dots, p\}$ that satisfies that $v \in A_j$, i.e., $\xi(v)$ is the index of the connected component of \mathcal{A} that contains v . Using this notation, we define a graph $G_{\mathcal{A}} = G / \{A_1, \dots, A_p\} = (V_{\mathcal{A}}, E_{\mathcal{A}})$ which results from contracting the connected components of \mathcal{A} in F . We set

$$V_{\mathcal{A}} := \{1, \dots, p\} \quad \text{and} \quad E_{\mathcal{A}} := \{e_f \mid f = \{v, w\} \in \mathcal{F}, \xi(v) \neq \xi(w)\}.$$

It is important that this definition removes all loops induced by the contraction, but it retains possible parallel edges. In this way, the edges of $G_{\mathcal{A}}$ correspond to the edges of \mathcal{F} that are crossing between the connected components of \mathcal{A} , while the nodes correspond to the components. Notice that $G_{\mathcal{A}}$ can be seen as a subgraph of $G_{\mathcal{A}}^{\text{all}}$ defined in the preliminaries for connecting moves. Thus, every tree in $G_{\mathcal{A}}$ induces a connecting move. We extend d to $G_{\mathcal{A}}$ by setting $d_{e_f} = d_f$ for all $e_f \in E_{\mathcal{A}}$. We also consider the graph $\hat{G}_{\mathcal{A}}$ on $V_{\mathcal{A}}$ that is the transitive closure of $G_{\mathcal{A}}$. For all pairs $j_1, j_2 \in V_{\mathcal{A}}$, it contains an additional edge $e'_{j_1 j_2}$ whose weight $d_{e'_{j_1 j_2}}$ is given by the length of a shortest j_1 - j_2 -path in $G_{\mathcal{A}}$.

For each $i \in \{1, \dots, q\}$, the simple cycle F_i in G induces a circuit C_i in $G_{\mathcal{A}}$. Figure 9 shows a cycle F_i and its induced circuit C_i . The edges of C_i correspond to those edges of F_i that we want to replace. Observe that C_i is indeed not necessarily simple: Whenever F_i revisits the connected component A_j of \mathcal{A} , the induced circuit C_i revisits the same node $j \in V_{\mathcal{A}}$. Assume C_i visits exactly s distinct vertices. Then we name them ξ_1, \dots, ξ_s and assume without loss of generality that $\xi_1 > \dots > \xi_s$. Since the connected components of \mathcal{A} are numbered according to their width, we know that $w(A_{\xi_1}) \geq \dots \geq w(A_{\xi_s})$, and thus the ξ_i are ordered according to the widths of the components as well. Finally, let n_ℓ be the number of times that C_i visits ξ_ℓ . In Figure 9, $\xi_1 = 7, \xi_2 = 5, \xi_3 = 4, \xi_4 = 1$, and $n_1 = 1, n_2 = 1, n_3 = 2$ and $n_4 = 1$.

The crucial idea for the replacement of C_i is to use the connecting move optimality[†] of \mathcal{A} to lower bound $d(C_i)$. Any subgraph of C_i that is a tree in $G_{\mathcal{A}}$ induces a connecting move. For an example, consider

[†]We will later use approximate moves, but for simplicity, we forget about approximate optimality during this explanation.

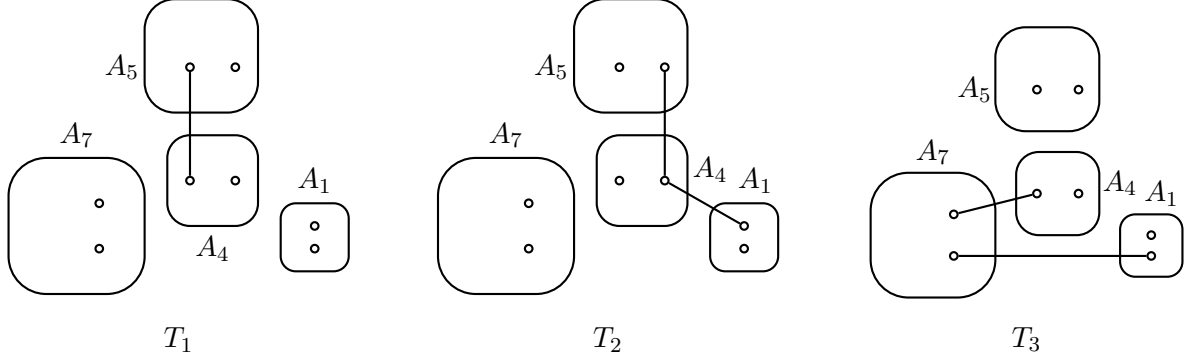

Figure 10: A partitioning of the blue circuit in Figure 9 into trees T_1, T_2, T_3 in $G_{\mathcal{A}}$. If none of the three induced connecting moves is improving, then $d(T_1) \geq w(A_4)$, $d(T_2) \geq w(A_4) + w(A_1)$ and $d(T_3) \geq w(A_4) + w(A_1)$. Thus, we get $d(C_i) \geq 3w(A_4) + 2w(A_1)$.

Figure 10. We partitioned the edges in C_i from Figure 9 into three trees. For any T_i among the three trees, connecting move optimality guarantees that the sum of the edges $d(T_i)$ is at least as expensive as the sum of the widths of the components that get connected, except for the largest. For example, when adding T_1 to the solution, the edge cost increases by $c(T_1)$, but the width cost decreases by $w(A_4)$. Thus, $d(T_1) \geq w(A_4)$ when \mathcal{A} is connecting move optimal. Since T_1, T_2 and T_3 are a edge-disjoint partitioning of C_i , it holds that $d(C_i) = d(T_1) + d(T_2) + d(T_3)$ and thus we get $d(C_i) \geq 3w(A_4) + 2w(A_1)$ by considering all three connecting moves.

Now consider Figure 11. Here, we partitioned the edges of C_i into a different set of trees. It turns out that this partitioning provides a better lower bound on $d(C_i)$, namely $w(A_5) + 2w(A_4) + 2w(A_1)$. In fact, this lower bound contains $w(A_{\xi_\ell})$ at least n_ℓ times for all $\ell \in \{2, 3, 4\}$. We observe a sufficient condition for guaranteeing that such a partitioning exists.

Definition 27. We say that a tree pays for ξ_ℓ (once) if it contains ξ_ℓ and at least one vertex $\xi_{\ell'}$ with $\xi_{\ell'} > \xi_\ell$.

Definition 28. Let $C = (e_1, \dots, e_{|C|})$ be a circuit in $G_{\mathcal{A}}$ that visits the nodes $v_1, \dots, v_{|C|+1} = v_1$ in this order. We say that C is guarded if we have $v_i < v_1$ for all $i \in \{2, \dots, |C|\}$. A circuit C is minimally guarded if it is guarded and no subcircuit $(v_{i_1}, \dots, v_{i_2})$ with $i_1, i_2 \in \{2, \dots, |C|\}$, $i_1 < i_2$ and $v_{i_1} = v_{i_2}$ is guarded.

Notice that in any guarded circuit, the highest component number only appears once. In Figure 9, C_i is minimally guarded because the only component visited between the two visits of A_4 is A_5 , which has a higher index.

Lemma 29. Let $C = (e_1, \dots, e_{|C|})$ be a guarded circuit in $G_{\mathcal{A}}$ that visits the nodes $v_1, \dots, v_{|C|+1} = v_1$ in this order. Assume that $v_1 = v_{|C|+1} \geq v_i$ for all $j \in \{2, \dots, |C|\}$ and that $\{v_1, \dots, v_{|C|}\}$ consists of s disjoint elements $\xi_1 > \xi_2 > \dots > \xi_s$ (this means that $v_1 = \xi_1$). Furthermore, let n_ℓ be the number of times that C visits node ξ_ℓ , for all $\ell = 1, \dots, s$. If \mathcal{A} is c -approximate connecting move optimal and there exists a set of trees \mathfrak{M} in $G_{\mathcal{A}}$ that satisfies that

1. all trees in \mathfrak{M} are edge-disjoint and only contain edges from C and
2. for all $\ell \in \{2, \dots, s\}$, there are at least n_ℓ trees in \mathfrak{M} that pay for ξ_ℓ ,

then it holds that

$$\sum_{i=2}^{|C|} w(A_{v_i}) = \sum_{\ell=2}^s n_\ell w(A_{\xi_\ell}) \leq c \cdot \sum_{i=1}^{|C|} d_{e_i} = c \cdot d(C).$$

Recall that A_{v_i} is the connected component of \mathcal{A} that corresponds to the index v_i .

Proof. By the first precondition we know that

$$\sum_{T \in \mathfrak{M}} \sum_{e \in T} d_e \leq \sum_{i=1}^{|C|} d_{e_i}.$$

Now notice that every tree in $G_{\mathcal{A}}$ and thus every tree in \mathfrak{M} defines a connecting move. Since \mathcal{A} is c -approximate connecting move optimal, it holds that

$$\sum_{v \in V[T]} w(A_v) - \max_{v \in V[T]} w(A_v) \leq c \cdot \sum_{e \in T} d_e$$

for every tree T in \mathfrak{M} . Let $low(T) = V[T] \setminus \{\max_{\xi_i \in T} \xi_i\}$. Then, we have

$$\begin{aligned} \sum_{i=2}^{|C|} w(A_{v_i}) &= \sum_{\ell=2}^s n_\ell w(A_{\xi_\ell}) \\ &\stackrel{2.}{\leq} \sum_{\ell=2}^s \sum_{T \in \mathfrak{M}} \mathbb{1}_{low(T)}(\xi_\ell) w(A_{\xi_\ell}) \\ &= \sum_{T \in \mathfrak{M}} \sum_{\ell=2}^s \mathbb{1}_{low(T)}(\xi_\ell) w(A_{\xi_\ell}) \\ &= \sum_{T \in \mathfrak{M}} \sum_{v \in low(T)} w(A_v) \\ &= \sum_{T \in \mathfrak{M}} \left(\sum_{v \in V[T]} w(A_v) - \max_{v \in V[T]} w(A_v) \right) \\ &\leq c \cdot \sum_{T \in \mathfrak{M}} \sum_{e \in T} d_e \end{aligned}$$

and this proves the lemma. □

8.1.2 The Partitioning Algorithm

We show how to partition minimally guarded circuits by providing Algorithm 1. It computes a sequence of sets \mathfrak{M}_k of trees. For $k \in \{2, \dots, s\}$, \mathfrak{M}_k contains a partitioning with n_i tree that each pay for ξ_i once, for all $i \in \{1, \dots, k\}$. The output of the algorithm is \mathfrak{M}_s .

The algorithm maintains a partitioning of C into a set of sub-paths \mathfrak{P}_k . While these paths are not necessarily simple, they are at all times edge-disjoint. The algorithm iteratively splits non-simple subpaths into simple subpaths. At the same time, it needs to make sure that the subpaths can be combined to trees that satisfy the conditions of Lemma 29. This is accomplished by building the trees of \mathfrak{M}_k in the transitive closure $\hat{G}_{\mathcal{A}}$ of $G_{\mathcal{A}}$: In this way, we can ensure that any edge of each tree in \mathfrak{M}_k corresponds to a path in the current partitioning \mathfrak{P}_k . More precisely, if a tree in \mathfrak{M}_k contains an edge (v, w) , then the partitioning contains a subpath (v, \dots, w) . This is why we say that a tree $T \in \mathfrak{M}_k$ *claims* a sub-path p of C if one of the edges in T corresponds to p . Each time the algorithm splits a sub-path, it also splits the corresponding edge of

Algorithm 1: A charging algorithm

input : A minimally guarded circuit $C = (v_1, \dots, v_{|C|+1})$ in $G_{\mathcal{A}}$ with $v_1 = v_{|C|+1}$.

Let $\{\xi_1, \dots, \xi_s\}$ be the set of disjoint vertices on C , w.l.o.g. $\xi_1 > \dots > \xi_s$.

output: A set \mathfrak{M} of edge disjoint trees in $G_{\mathcal{A}}$ consisting of edges from C

Initialization: Observe that ξ_2 can only occur once on C . If $v_{i_1}, v_{i_2} \in C$ with $i_1 \neq i_2$, but $v_{i_1} = v_{i_2} = \xi_2$, then the subcircuit $(v_{i_1}, \dots, v_{i_2})$ certifies that C is not minimally guarded.

```

1  let  $v$  be the unique node in  $C$  with  $v = \xi_2$ .
2  let  $T = \{\{v_1, v\}\}$  and let  $\mathfrak{M}_2 = \{(T, v_1)\}$            T is stored with root  $v_1$ 
3  let  $\mathfrak{P}_2 = \{(v_1, \dots, v), (v, \dots, v_{|C|-1})\}$ .       the second part of  $C$  is unclaimed
   Main loop: Iteration  $k$  computes  $\mathfrak{M}_k$  and  $\mathfrak{P}_k$ 
4  foreach  $k = 3, \dots, s$  do
5    let  $\mathfrak{M}_k = \mathfrak{M}_{k-1}$  and let  $\mathfrak{P}_k = \mathfrak{P}_{k-1}$ 
   We need to process all occurrences of  $\xi_k$  on  $C$ , so we store their indices in  $I$ 
6    let  $I = \{j \in \{2, \dots, |C| - 1\} \mid v_j = \xi_k\}$ .
   Find the path  $P_j$  that  $j$  lies on. We assume that  $v_{P_j}$  occurs before  $w_{P_j}$  on  $C$ 
7    let  $P_j = (v_{P_j}, \dots, w_{P_j})$  be the path in  $\mathfrak{P}_{k-1}$  with  $j$  as inner node, for all  $j \in I$ .
   First case: Treats all occurrences of  $\xi_k$  in unclaimed parts of  $C$  by creating new trees.
8    foreach  $j \in I$  with  $\pi_{k-1}(P_j) = \perp$  do
9      let  $T = \{\{v_{P_j}, v_j\}\}$  and let  $\mathfrak{M}_k = \mathfrak{M}_k \cup \{(T, v_{P_j})\}$            new tree claims left part
10     let  $\mathfrak{P}_k = \mathfrak{P}_k \setminus \{P_j\} \cup \{(v_{P_j}, \dots, v_j), (v_j, \dots, w_{P_j})\}$            path  $P_j$  is split at  $v_j$ 
11   end
   Second case: Treats all occurrences of  $\xi_k$  that fall on edges of trees in  $\mathfrak{M}_k$ . This is done by iterating through all trees and processing all occurrences in the same tree together.
12   foreach  $(T, r) \in \mathfrak{M}_{k-1}$  do
13     let  $I_T = \{j \in I \mid \pi_{k-1}(P_j) \in T\}$ 
14     if  $I_T = \emptyset$  then continue           If  $I_T$  is empty, then  $T$  remains unchanged
15     select  $j^* \in I_T$  such that the path from  $j^*$  to  $r$  in  $T$  contains no  $j \in I_T \setminus \{j^*\}$ 
    $T$  is modified to include  $j^*$ . Notice that  $\pi_{k-1}(P_{j^*}) = \{v_{P_{j^*}}, w_{P_{j^*}}\}$ .
16     let  $T = T \setminus \{\{v_{P_{j^*}}, w_{P_{j^*}}\}\} \cup \{\{v_{P_{j^*}}, v_{j^*}\}, \{v_{j^*}, w_{P_{j^*}}\}\}$ 
17     let  $\mathfrak{P}_k = \mathfrak{P}_k \setminus \{P_{j^*}\} \cup \{(v_{P_{j^*}}, \dots, v_{j^*}), (v_{j^*}, \dots, w_{P_{j^*}})\}$ 
18     foreach  $j \in I_T \setminus \{j^*\}$  do
   Any edge containing a  $j \neq j^*$  is split: Half of the edge becomes a new tree, and the other half is used to keep the tree connected. Notice that  $\pi_{k-1}(P_j) = \{v_{P_j}, w_{P_j}\}$ .
19       let  $T = T \setminus \{\{v_{P_j}, w_{P_j}\}\} \cup \{\{v_j, w_{P_j}\}\}$ 
20       let  $T' = \{\{v_{P_j}, v_j\}\}$  and let  $\mathfrak{M}_k = \mathfrak{M}_k \cup \{(T', v_{P_j})\}$ 
21       let  $\mathfrak{P}_k = \mathfrak{P}_k \setminus \{P_j\} \cup \{(v_{P_j}, \dots, v_j), (v_j, \dots, w_{P_j})\}$ 
22     end
23   end
24 end
25 return  $\mathfrak{M}_s$ 

```

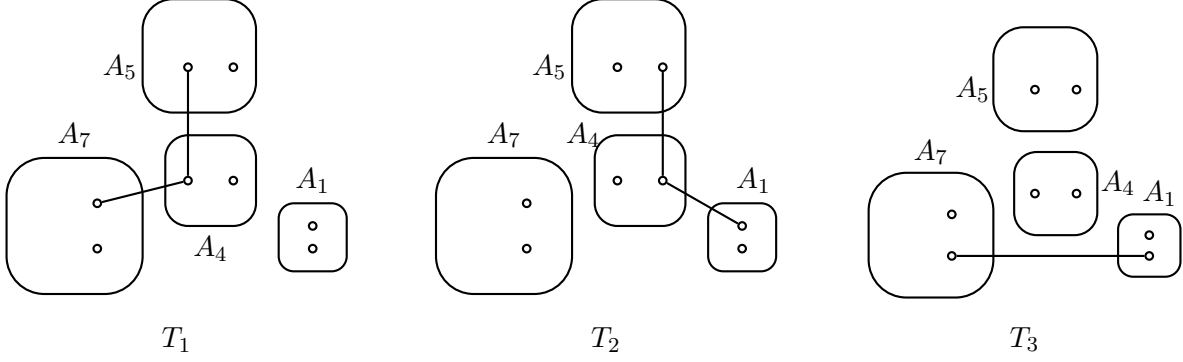

Figure 11: A different partitioning of the blue circuit in 9 into trees T_1, T_2, T_3 in $G_{\mathcal{A}}$. If none of the three induced connecting moves is improving, then $d(T_1) \geq w(A_5) + w(A_4)$, $d(T_2) \geq w(A_4) + w(A_1)$ and $d(T_3) \geq w(A_1)$. Thus, we get $d(C_i) \geq w(A_5) + 2w(A_4) + 2w(A_1) \geq n_2w(A_5) + n_3w(A_4) + n_4w(A_1)$.

a tree in \mathfrak{M}_k . To represent the correspondence of trees and subpaths, we define the mapping $\pi_k : \mathfrak{P}_k \rightarrow \cup_{T \in \mathfrak{M}_k} T \times \{\perp\}$ that maps a path $p = (v, \dots, w) \in \mathfrak{P}_k$ to an edge $e \in \cup_{T \in \mathfrak{M}_k} T$ if and only if $e \cap p = \{v, w\}$. If no such edge exists, then $\pi_k(p) = \perp$. This mapping is well-defined. The trees in the final set \mathfrak{M}_s do not contain transitive edges, i.e., they are subgraphs of $G_{\mathcal{A}}$. They also leave no part of C unclaimed.

We now describe the algorithm in more detail and simultaneously observe its main property:

Invariant 30. For all $k = 2, \dots, s$, it holds after iteration k that for all $i \in \{2, \dots, k\}$ there are at least n_i trees in \mathfrak{M}_k that pay for ξ_i .

For presentation purposes, we assume that we already know that the following invariants are true and prove them later in Lemma 33. An example run of the algorithm to accompany the explanation can be found in Figure 12. Notice that the trees in \mathfrak{M}_k are rooted, i.e., we store each tree as a tuple consisting of the actual tree plus a root. The trees in connecting moves are unrooted, the roots in \mathfrak{M}_k are only needed for the computation.

Invariants 31. For all $k = 2, \dots, s$, the following holds:

1. The trees in \mathfrak{M}_k are edge disjoint.
2. The paths in \mathfrak{P}_k are edge-disjoint and it holds that $\cup_{p \in \mathfrak{P}_k} p = C \setminus \{\{v_{|C|}, v_{|C|+1}\}\}$.
3. If v is an outer node of some $p \in \mathfrak{P}_k$, then $v \in \{\xi_1, \dots, \xi_k\}$. If v is an inner node, then $v \in \{\xi_{k+1}, \dots, \xi_s\}$.
4. For any $e \in T$, $T \in \mathfrak{M}_k$, $\pi_k^{-1}(e)$ consists of one path from \mathfrak{P}_k .
5. If $\{v_{j_1}, v_{j_2}\}$ with $j_1 < j_2$ is an edge in T , $(T, r) \in \mathfrak{M}_k$, then v_{j_1} is closer to r than v_{j_2} .

The initialization consists of setting \mathfrak{M}_2 and \mathfrak{P}_2 . Observe that ξ_2 is visited exactly once by C : If there were $v_i, v_j \in C$ with $i \neq j$, but $v_i = v_j = \xi_2$, the sub-circuit (v_i, \dots, v_j) would be such that $v_i > v_j$ for all $j \in \{i+1, \dots, j-1\}$, because ξ_1 only occurs at v_1 and $v_{|C|+1}$. This would be a contradiction to the assumption that C is minimally guarded.

The algorithm splits $(v_1, \dots, v_{|C|})$ at the unique occurrence v of ξ_2 on C . This is done by setting \mathfrak{P}_2 to consist of the paths (v_1, \dots, v) and $(v, \dots, v_{|C|})$ and by inserting the tree $T = \{\{v_1, v\}\}$ with root v_1 into

\mathfrak{M}_2 . Notice that now $\pi_2((v_1, \dots, v)) = \{v_1, v\}$ in T and $\pi_2((v, \dots, v_{|C|})) = \perp$. Invariant 30 is true because there is now one tree paying for ξ_2 .

For $k \geq 3$, we assume that the properties are true for $k - 1$ by induction. The algorithm starts by setting $\mathfrak{M}_k = \mathfrak{M}_{k-1}$ and $\mathfrak{P}_k = \mathfrak{P}_{k-1}$. Then it considers the set $I = \{j \mid v_j = \xi_k\}$ of all occurrences of ξ_k on C . For all $j \in I$ it follows from Properties 31-2 and 31-3 that there is a unique path $P_j = (v_{P_j}, \dots, w_{P_j})$ in \mathfrak{P}_{k-1} with $j \in P_j$. The algorithm defines P_j in Line 7. We know that the paths P_j are different for all $j \in I$: By Property 31-3, all inner nodes are ξ_k or a ξ_ℓ with higher index. If at least two occurrences of ξ_k would fall on the same P_j , take the two that are closest together: All nodes between them would be equal to a $\xi_{j'}$ with $j' > k$, which contradicts the assumption that C is minimally guarded (because the ξ_ℓ are sorted decreasingly). Thus, all $j \in I$ have a distinct P_j that they lie on. During the whole algorithm, the endpoints of P_j are always named v_{P_j} and w_{P_j} , where v_{P_j} occurs first on C .

Suppose that $\pi_{k-1}(P_j) \neq \perp$. The algorithm deals with all j that satisfy this in the for loop that starts in Line 12. For any T with occurrences of ξ_k , it considers $I_T = \{j \in I \mid \pi_{k-1}(P_j) \in T\}$, the set of all occurrences of ξ_k that fall into the same tree $T \in \mathfrak{M}_{k-1}$. It selects a node $j^* \in I_T$ whose unique path to the root of T does not contain any other $j \in I_T$. This node must exist because T is a tree. The algorithm updates T , and adds a new tree for any $j \in I_T \setminus \{j^*\}$. The idea is that the edge that j^* falls on is divided into two edges that stay in T , while all other edges are split into an edge that stays in T and an edge that forms a new tree. Since all v_j with $j \in I_T$ represent the same connected component, T stays connected.

More precisely, for j^* the edge $\{v_{p_{j^*}}, w_{p_{j^*}}\}$ is divided in T and is replaced by two edges $\{v_{p_{j^*}}, v_{j^*}\}$ and $\{v_{j^*}, w_{p_{j^*}}\}$. For all $j \in I_T \setminus \{j^*\}$, the algorithm replaces $\{v_{p_j}, w_{p_j}\}$ by $\{v_j, w_{P_j}\}$ in T . By Property 31-5, we know that v_{P_j} is closer to the root r of T . Thus, removing $\{v_{p_j}, w_{p_j}\}$ disconnects the subtree at w_{p_j} from r . However, adding $\{v_j, w_{P_j}\}$ reconnects the tree because v_j and v_{j^*} are the same node and the algorithm assured that $v_{j^*} \in V[T]$. Thus, T stays connected. The algorithm also adds the new tree $\{\{v_{P_j}, v_j\}\}$ to \mathfrak{M}_k which it can do because this part of C is now free.

The algorithm also updates \mathfrak{P}_k by removing P_j , inserting $\{v_{P_j}, \dots, v_j\}$ and $\{v_j, \dots, w_{P_j}\}$ instead, thus splitting P_j at v_j for all $j \in I_T$ including j^* .

The algorithm also processes all $j \in I$ where $\pi_{k-1}(P_j) = \perp$. This is done in the for loop in Line 8. In this case, the path P_j is split at node j by removing P_j from \mathfrak{P}_k . Then, the algorithm inserts its two parts (v_{P_j}, \dots, v_j) and (v_j, \dots, w_{P_j}) into \mathfrak{P}_k to \mathfrak{P}_k . It also adds a new tree $\{\{v_{P_j}, v_j\}\}$ with root v_{P_j} to \mathfrak{M}_k .

Notice that all trees that are created satisfy that there is a vertex with a higher number than ξ_k : if a vertex is added into a tree, then the other vertices in the tree have higher value, and if a new tree is created, then it consists of an edge to a vertex which previously was an endpoint of a path, and these have numbers in $\{\xi_1, \dots, \xi_{k-1}\}$. For every $j \in I$, it either happens that a tree is updated or that a new tree is created. Thus, the set \mathfrak{M}_k satisfies Invariant 30 when the iteration is completed.

Lemma 32. *Invariant 30 holds.*

Verifying the other invariants consists of checking all updates on \mathfrak{M}_k and \mathfrak{P}_k .

Lemma 33. *Invariants 31 hold.*

Proof. It is easy to verify that all properties hold for $k = 2$ since the algorithm sets $\mathfrak{M}_2 = (\{v_1, v\}, v_1)$ and $\mathfrak{P}_2 = \{(v_1, \dots, v), (v, \dots, v_{|C|-1})\}$. Property 31-1 is also true for the new tree created in Line 9 because it is only executed if P_j is unclaimed. Line 16 subdivides an edge into two. Lines 19 and 20 split an existing edge and distributes it among T and T' . Thus, Property 31-1 is preserved. For Property 31-2, consider Lines 10, 17 and 21 to verify that paths are only split into subpaths and no edges are lost. Property 31-3 stays true because iteration k processes all occurrences of ξ_k and always executes one of the Lines 10, 17 and 21,

thus splitting the corresponding paths such that ξ_k becomes an outer node. Lines 9, 10, 16, 17, 19, 20, 21 affect Property 31-4. In all cases, \mathfrak{M}_k and \mathfrak{P}_k are adjusted consistently.

Finally, consider Property 31-5. Line 9 creates a new tree by claiming (v_{P_j}, \dots, v_j) of the unclaimed edges on $(v_{P_j}, \dots, w_{P_j})$. Notice that we assume that v_{P_j} occurs on C before v_{P_j} . Thus, assuming that Property 31-5 holds for all trees existing before Line 9, we see that it also holds for the new tree. Line 16 modifies a tree T by inserting v_{j^*} into an edge. Since v_{j^*} is an inner node of $(v_{P_{j^*}}, \dots, w_{j^*})$, Property 31-5 is preserved. Line 19 splits edge $\{v_{P_j}, w_{P_j}\}$. Again, recall that v_{P_j} occurs before w_{P_j} on C and thus inductively is closer to r . Further notice that v_j occurs before w_{P_j} and that w_{P_j} gets disconnected from r when $\{v_{P_j}, w_{P_j}\}$ is removed. It is then reconnected to r by adding $\{v_j, w_{P_j}\}$. This means that v_j is closer to r than w_{P_j} . Line 20 creates a new tree that satisfies Property 31-5 because v_{P_j} occurs on C before v_j . \square

Corollary 34. *Assume that \mathcal{A} is c -approximate connecting move optimal. Let $C = (v_1, \dots, v_l)$ be a circuit in $G_{\mathcal{A}}$ with edges (e_1, \dots, e_l) . If C is minimally guarded, then*

$$\sum_{i=2}^{l-1} w(T_{v_i}) \leq c \cdot \sum_{i=1}^l d_{e_i} = c \cdot d(C)$$

Proof. For all $T \in \mathfrak{M}$ and all edges $e \in T \subseteq \mathfrak{M}_s$, Property 31-4 says that there is a unique path $\pi^{-1}(e) \in \mathfrak{P}_s$. Property 31-3 for $k = s$ means that paths can no longer have inner nodes. Thus, $\pi^{-1}(e)$ is a single edge, and therefore, e also exist in $G_{\mathcal{A}}$. Thus, all trees in \mathfrak{M}_s are trees in $G_{\mathcal{A}}$. By Property 31-4, the trees are edge disjoint. Lemma 32 ensures that they satisfy the precondition of Lemma 29. The corollary then follows. \square

As before, we set $\xi(v) = j$ for the unique $j \in \{1, \dots, p\}$ with $v \in A_j$, for all $v \in V$. For any edge set F in G , we define $F_{\circ} := \{e = \{u, v\} \in F \mid \xi(u) = \xi(v)\}$ and $F_{\leftrightarrow} := \{e = \{u, v\} \in F \mid \xi(u) \neq \xi(v)\}$ as the subset of edges of F within components of \mathcal{A} or between them, respectively. Furthermore, if an edge set F' in G satisfies $V[F'] \subseteq V[A_j]$ for a $j \in \{1, \dots, p\}$, then we set $\xi(F') = j$. Notice that in this case, $F' = F'_{\circ}$.

Lemma 35. *Let \bar{F} be a simple path in G that starts and ends in the same connected component T_{j^*} of \mathcal{A} and satisfies that $\xi(v) \leq j^*$ for all $v \in V[\bar{F}]$. Assume that $\bar{F} \neq \bar{F}_{\circ}$. Assume that \mathcal{A} is edge/set and path/set swap-optimal with respect to $\bar{F}_{\leftrightarrow}$ and that \mathcal{A} is c -approximate connecting move optimal.*

Then, there exists a set R of edges on the vertices $V[\bar{F}_{\leftrightarrow}]$ with $(\bar{F}_{\circ} \cup R)_{\leftrightarrow} = (\bar{F}_{\circ} \cup R)$ that satisfies the properties listed below. Let F'_1, \dots, F'_x be the connected components of $\bar{F}_{\circ} \cup R$ in $(V[F'], E[F'])$.

1. \mathcal{A} is edge/set swap-optimal with respect to R .
2. It holds that $d(R) \leq d(\bar{F}_{\leftrightarrow})$ and $\sum_{\ell=2}^x w(T_{\xi(F'_\ell)}) \leq c \cdot d(\bar{F}_{\leftrightarrow})$.
3. For all F'_ℓ , there exists an index j such that $V[F'_\ell] \subseteq V[A_j]$ (thus, $\xi(F'_\ell) = j$).
4. There is only one F'_ℓ with $\xi(F'_\ell) = j^*$, assume w.l.o.g. that $\xi(F'_1) = j^*$.

Proof. Let $\bar{F} = (s, \dots, v_1, w_1, \dots, w_2, v_2, \dots, t)$ where (s, \dots, v_1) and (v_2, \dots, t) are the prefix and suffix of \bar{F} lying in T_{j^*} , i.e., we assume that $s, \dots, v_1 \in T_{j^*}$, $v_2, \dots, t \in T_{j^*}$ and $w_1, w_2 \notin T_{j^*}$. The nodes s and v_1 may coincide as well as v_2 and t . Let \bar{C} be the circuit that \bar{F} induces in $G_{\mathcal{A}}$.

We do induction on the inclusion-wise hierarchy of guarded circuits. Thus, our base case is that \bar{C} is minimally guarded. In this case, we know that all vertices v from (w_1, \dots, w_2) satisfy $\xi(v) < j^*$. We set $R = \{\bar{e}\}$ with $\bar{e} := \{v_1, v_2\}$ and $d(\bar{e}) := d(\bar{F}_{\leftrightarrow})$ and show that R satisfies Properties 35-1–35-4. For

Property 35-1, we need path/set swap optimality. Picking v_1 and v_2 uniquely defines a set of edges X which form a shortest path from v_1 to v_2 in the contracted graph and which every v_1 - v_2 -based path move adds. Let (\bar{e}, S) be a edge/set swap that adds \bar{e} . We argue that this move cannot be improving because otherwise, the path/set swap (X, S) was improving. Let $loss(X)$ be the increase that adding X to \mathcal{A} incurs in ϕ , and let $gain(S)$ be the amount by which deleting S decreases ϕ . Assume that (\bar{e}, S) is improving, i.e., $d(\bar{e}) = d(\bar{F}_{\leftrightarrow}) < gain(S)$. Notice that $\bar{F}_{\leftrightarrow}$ is a path from v_1 to v_2 in the contracted graph. Thus, $d(\bar{F}_{\leftrightarrow}) \geq d(X)$. Furthermore, notice that $loss(X) \leq d(X)$. Thus, $loss(X) \leq d(\bar{F}_{\leftrightarrow})$, such that our assumption implies $loss(X) < gain(S)$. That is a contradiction to path/set swap optimality. Property 35-1 holds.

Property 35-2 is true because $d(F') = d(\bar{F}_{\leftrightarrow})$ and by Corollary 34 since $d(\bar{F}_{\leftrightarrow}) = d(\bar{C})$. Now we look at the connected components of $\bar{F}_{\circ} \cup R$. They are equal to the connected components of \bar{F}_{\circ} except that we add the edge e . Notice that \bar{F}_{\circ} only contains edges that go within the same component, and that that e connects two vertices from the same component. Thus, Property 35-4 holds. Furthermore, notice that \bar{F}_{\circ} has exactly two connected components consisting of vertices from T_{j^*} : The vertices on the prefix and suffix of \bar{F} . These components are connected by $e = \{v_1, v_2\}$. Thus, Property 35-2 holds.

Now assume that \bar{C} is not minimally guarded. First assume that \bar{C} is not guarded. Define v_1 and v_2 as before. Since \bar{C} is not guarded, \bar{F} has to visit T_{j^*} again between v_1 and v_2 . Let v_3 and v_4 be the first and last vertex of one arbitrary visit to T_{j^*} between v_1 and v_2 . It is possible that $v_3 = v_4$, otherwise, notice that v_3 and v_4 are connected in \bar{F}_{\circ} . We split \bar{F} into two paths $P_1 := (v_1, \dots, v_3)$ and $P_2 := (v_4, \dots, v_2)$ and obtain two sets $F^{1'}$ and $F^{2'}$ by using the induction hypothesis on the two inclusionwise smaller paths. By induction hypothesis, v_1, v_3 and all other occurrences of vertices from T_{j^*} in P_1 have to be connected in $\bar{F}_{\circ} \cup F^{1'}$. Also, v_4, v_2 and all other occurrences of vertices from T_{j^*} in P_2 have to be connected in $\bar{F}_{\circ} \cup F^{2'}$. Thus, all occurrences of vertices from T_{j^*} on \bar{F} are connected in $\bar{F}_{\circ} \cup F^{1'} \cup F^{2'}$ because v_3 is connected to v_4 in \bar{F}_{\circ} . So, Property 35-4 holds. Furthermore, since \bar{F} is a simple path, no other components of $F^{1'}$ and $F^{2'}$ can contain the same vertex because only v_3 is in both P_1 and P_2 . Thus, Property 35-3 holds for $F^{1'} \cup F^{2'}$ since it holds for $F^{1'}$ and $F^{2'}$ individually. If \mathcal{A} is edge/set swap-optimal with respect to a set A and also with respect to a set B , then it is edge/set swap-optimal with respect to $A \cup B$, thus Property 35-1 holds for $F^{1'} \cup F^{2'}$. Similarly, Property 35-2 holds because it holds for $F^{1'}$ and $F^{2'}$ individually with respect to disjoint parts of $\bar{F}_{\leftrightarrow}$.

Finally, assume that \bar{F} is guarded, but not minimally guarded. Define v_1 and v_2 as before. Since \bar{F} is guarded, but not minimally guarded, it visits a connected component T_j with $j < j^*$ twice between v_1 and v_2 , and between these two visits, it never visits a component $T_{j'}$ with $j' > j$. Pick a j and two visits of T_j with this property, and let v_3 be the last vertex in the first of these visits of T_j and let v_4 be the first vertex of the second visit of T_j . Again, $v_3 = v_4$ is possible and otherwise, v_3 and v_4 are connected in \bar{F}_{\circ} . We apply the induction to the path \bar{F}' which is the subpath (v_3, \dots, v_4) and obtain a set F' by the induction hypothesis. Additionally, we create \bar{F}'' from \bar{F} by replacing the subpath (v_3, \dots, v_4) by the edge (v_3, v_4) . Since this path is shorter, we can apply the induction hypothesis to \bar{F}'' to obtain a set F'' . We claim that $F' \cup F''$ satisfies all properties. Notice that $\bar{F}_{\leftrightarrow} = \bar{F}'_{\leftrightarrow} \cup \bar{F}''_{\leftrightarrow}$. Again, Property 35-1 is true because $F' \cup F''$ is the union of two sets that satisfy Property 35-1.

What are the connected components of $\bar{F}_{\circ} \cup F' \cup F''$? Let \mathcal{CC} be the set of connected components of \bar{F}_{\circ} , and define \mathcal{CC}' and \mathcal{CC}'' to be the connected components of $\bar{F}_{\circ} \cup F'$ and $\bar{F}_{\circ} \cup F''$, respectively. All edges in $F' \cup F''$ go between different components in \mathcal{CC} , and F' and F'' are defined on vertex sets that are disjoint with the exception of v_3 and v_4 . Both \mathcal{C}' and \mathcal{C}'' contain exactly one connected component which contains both v_3 and v_4 (notice that v_3 and v_4 are connected in \bar{F}'' and \bar{F}_{\circ}). In \mathcal{C}' , it is the connected component with the highest width (i.e., F'_1), but in \mathcal{C}'' , the component with the highest width is the component that contains v_1 and v_2 . Thus, $v_1, v_2 \in F''_1$ and $v_3, v_4 \in F''_{j''}$ with $j'' \neq 1$. In $\bar{F}_{\circ} \cup F' \cup F''$, F'_1 and $F''_{j''}$ are merged into

one connected component because they both contain v_3 and v_4 , meaning that $w(F'_1) = w(F_{j''})$ is counted twice when applying Property 35-2 for F' and F'' compared to applying Property 35-2 to $F' \cup F''$. All other components in \mathcal{C}' and \mathcal{C}'' are defined on disjoint vertex sets and thus $\bar{F}_\circ \cup F' \cup F''$ is the disjoint union of $\mathcal{C}\mathcal{C}' \setminus \{F'_1\}$, $\mathcal{C}\mathcal{C}'' \setminus \{F_{j''}\}$ and $\{F'_1 \cup F_{j''}\}$. We see that Property 35-3 and 35-4 carry over to $F' \cup F''$ from holding for F' and F'' . Name the connected components of $\bar{F}_\circ \cup F' \cup F''$ as F'''_1, \dots, F'''_y . The component with the highest width among these, F'''_1 , is the one that contains v_1 and v_2 , i.e., $F'''_1 = F''_1$. We thus have

$$\sum_{\ell=2}^y w(T_{\xi(F'''_\ell)}) = \sum_{\ell=2}^{x'} w(T_{\xi(F'_\ell)}) + \sum_{\ell=2}^{x''} w(T_{\xi(F''_\ell)}) \leq c \cdot d(F'_{\leftrightarrow}) + c \cdot d(F''_{\leftrightarrow}) = c \cdot d(\bar{F}_{\leftrightarrow}).$$

Since $\bar{F}_{\leftrightarrow} = \bar{F}'_{\leftrightarrow} \cup F''_{\leftrightarrow}$ and $d(F') \leq d(\bar{F}'_{\leftrightarrow})$ and $d(F'') \leq d(\bar{F}''_{\leftrightarrow})$ by the induction hypothesis, we have $d(F' \cup F'') \leq d(\bar{F}_{\leftrightarrow})$ and thus $F' \cup F''$ satisfies Property 35-2. \square

Figure 13-21 illustrate how F' is constructed recursively.

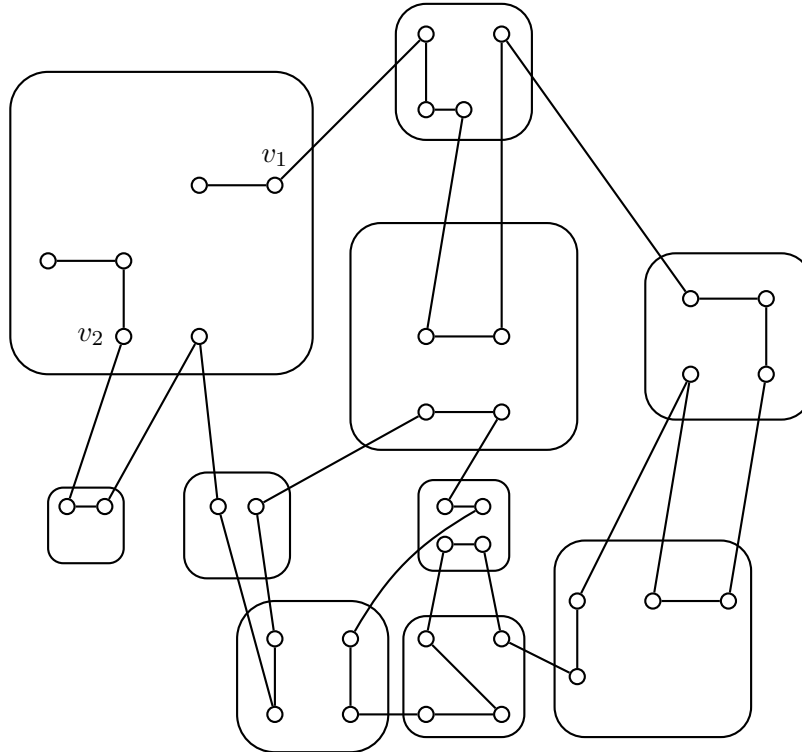

Figure 13: The rounded rectangles visualize the connected components of \mathcal{A} , their size indicates their width. We see a path \bar{F} that corresponds to a circuit in $G_{\mathcal{A}}$ which is guarded, but not minimally guarded. We pick v_1 and v_2 as described.

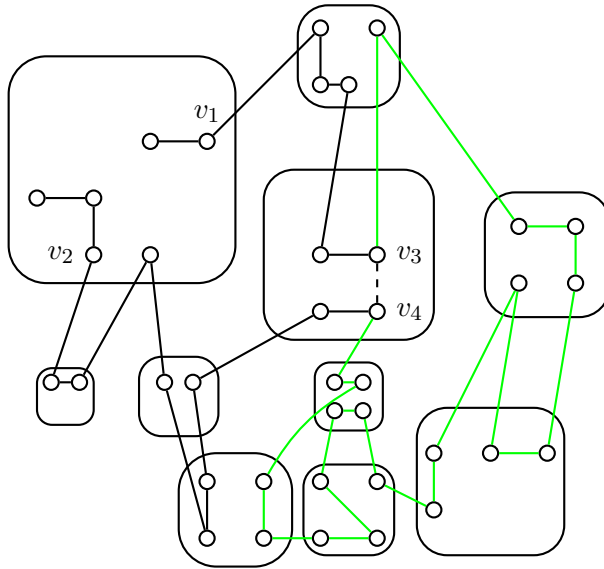

Figure 14: We identify suitable v_3 and v_4 and split the path into two paths: The green path, and the black path that now contains the dashed edge.

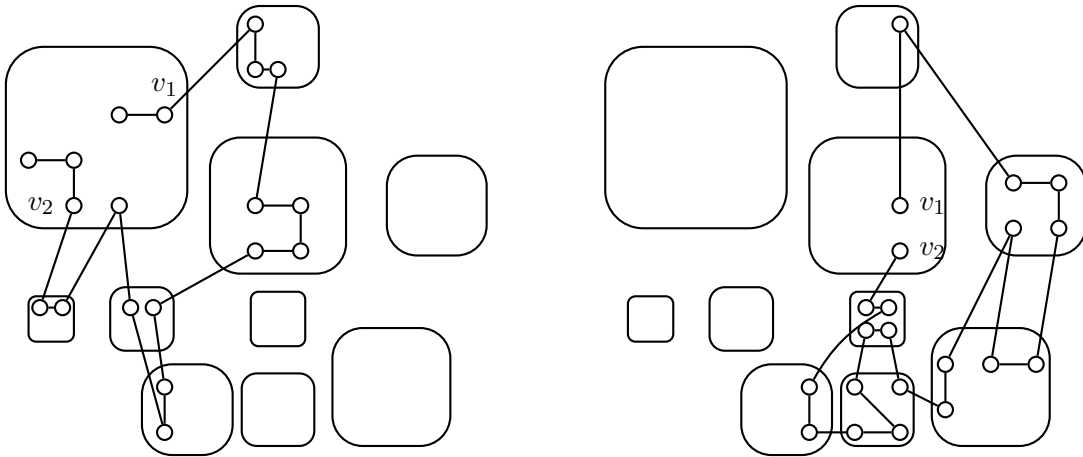

Figure 15: These are the two paths for which we use the induction hypothesis. Both are guarded, but not minimally guarded.

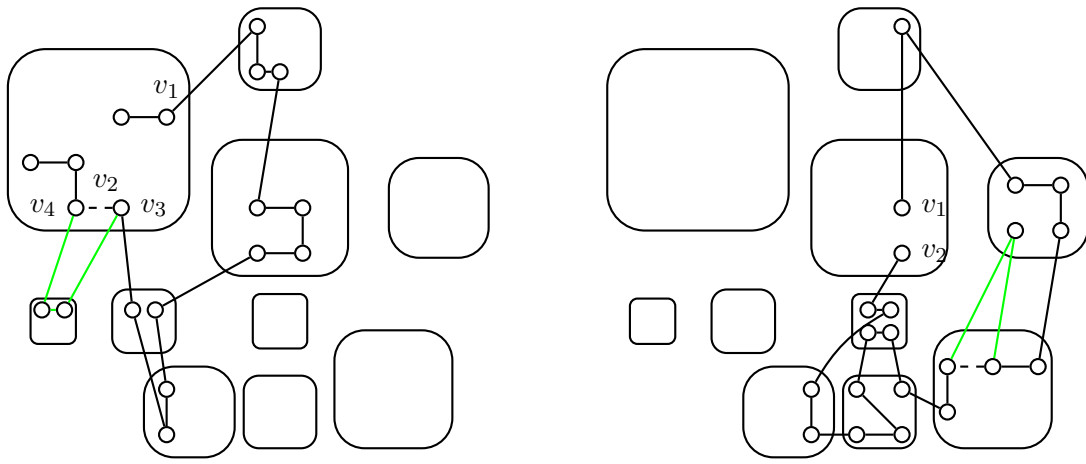

Figure 16: We identify v_3 and v_4 for the two paths in Figure 15 and split the path into the green part and the black part with the dashed edge.

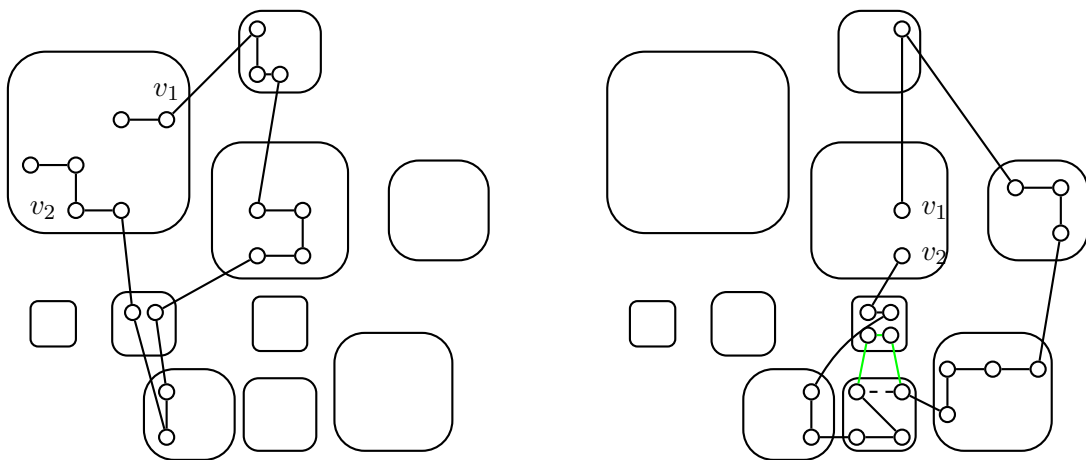

Figure 17: These are the two black paths. The left one is now minimally guarded, but the right one is split again.

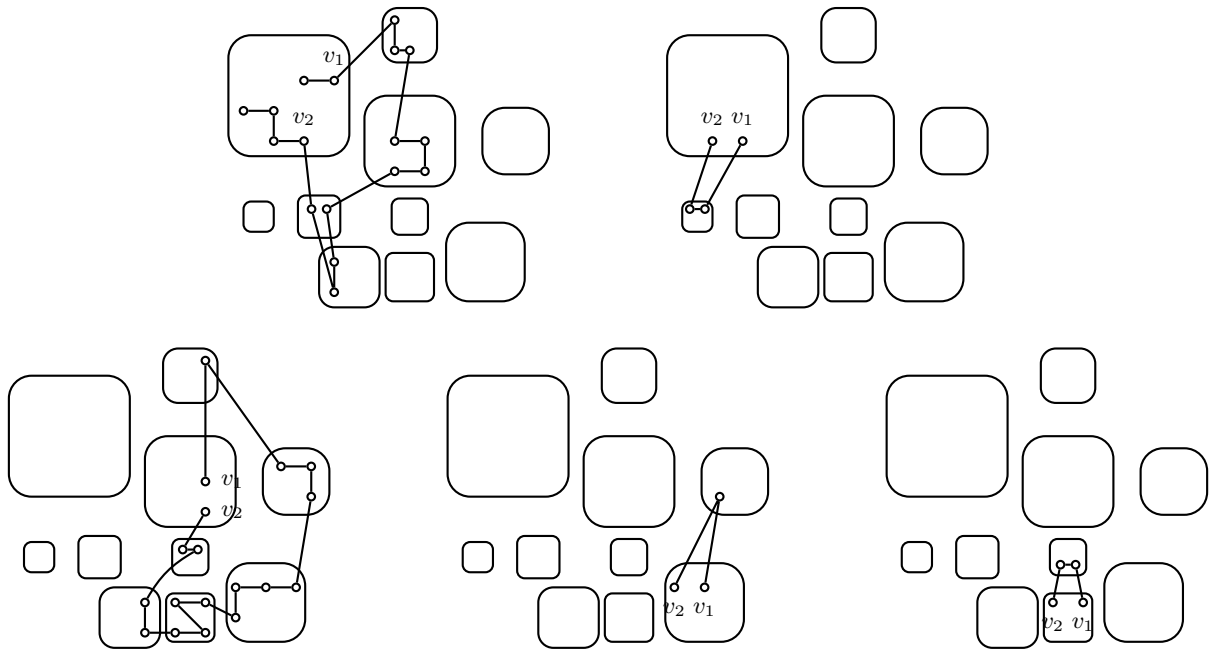

Figure 18: The five base cases that occur.

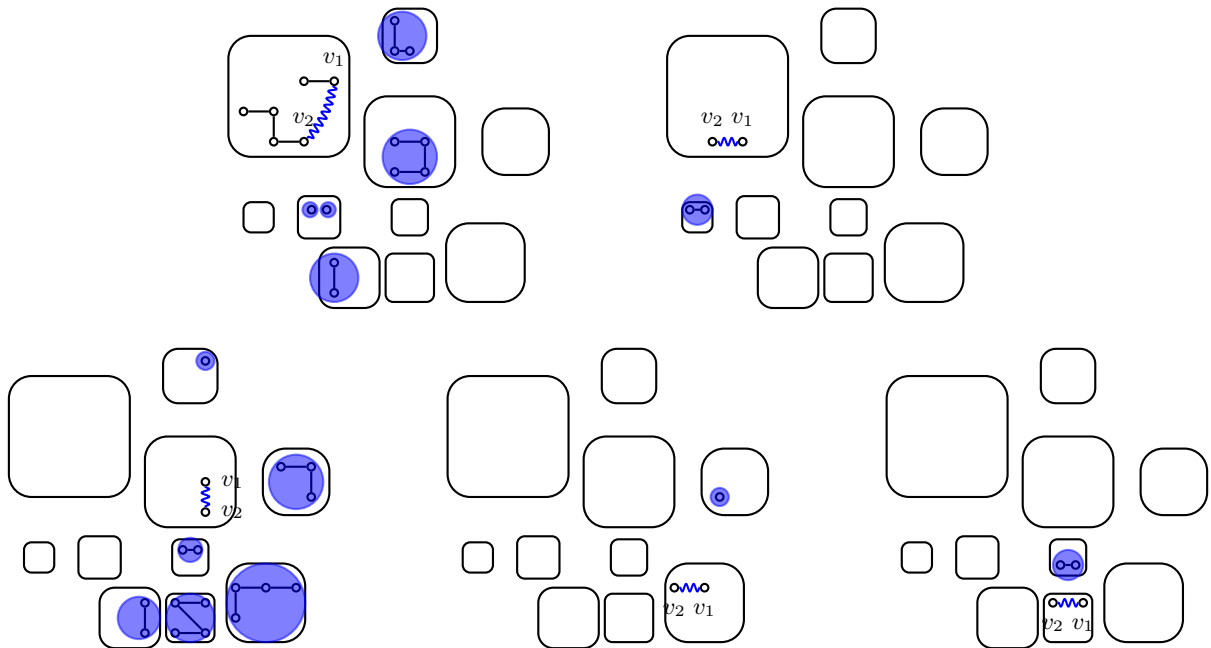

Figure 19: We get that the blue edges cost at most the same as the black edges in Figure 18, and that summing the widths for all blue components costs at most the cost of the black edges in Figure 18 as well.

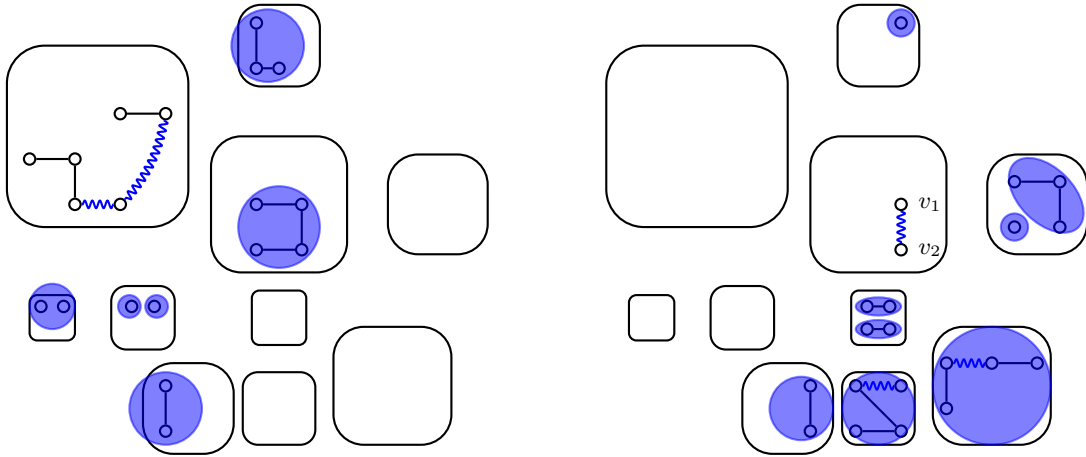

Figure 20: The result of the induction for the paths in Figure 15

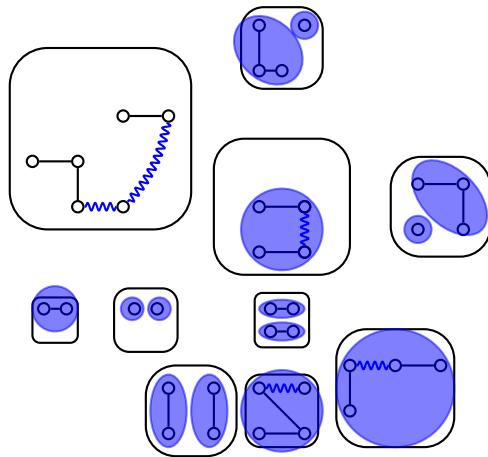

Figure 21: Final set F' and connected components of $F' \cup \bar{F}_O$.

8.1.3 Wrapping Up

Lemma 36. *Let $G = (V, E)$ be a complete graph, let $d : E \rightarrow \mathbb{R}_{\geq 0}$ be a metric that assigns a cost d_e to every edge $e \in E$ and let $\mathfrak{T} \subseteq V \times V$ be a set of terminal pairs. Let $\mathcal{A}, \mathcal{F} \subseteq E$ be two feasible Steiner Forest solutions for (G, \mathfrak{T}) . Furthermore, suppose that \mathcal{A} is edge/edge, edge/set and path/set swap-optimal with respect to E and ϕ , that \mathcal{A} is c -approximate connecting move optimal and that \mathcal{A} only uses edges between terminals. Then there exists a feasible solution \mathcal{F}' with $d(\mathcal{F}') \leq 2(1 + c) \cdot d(\mathcal{F})$ that satisfies $\mathcal{F}' = \mathcal{F}'_{\circ}$ such that \mathcal{A} is edge/edge and edge/set swap-optimal with respect to \mathcal{F}' .*

Proof. By Observation 26, we know that by accepting a factor of 2 in the cost, we can assume that the connected components F_1, \dots, F_q of \mathcal{F} are node disjoint cycles and that $V[\mathcal{F}] = V[\mathcal{A}]$ equals the set of all terminals. The connected components of \mathcal{A} are T_1, \dots, T_p . Recall that we use $\xi(v)$ for the index of the component T_j that v lies in, and we use $F_{\circ} := \{e = \{u, v\} \in F \mid \xi(u) = \xi(v)\}$ and $F_{\leftrightarrow} := \{e = \{u, v\} \in F \mid \xi(u) \neq \xi(v)\}$ for any edge set F for the set of edges within components of \mathcal{A} or between them, respectively. Also, if an edge set F' in G satisfies $V[F'] \subseteq V[T_j]$ for a $j \in \{1, \dots, p\}$, then we use $\xi(F') = j$. We want to replace all cycles F_i by sets F'_i which satisfy $F'_i = (F'_i)_{\circ}$ while keeping the solution feasible and within a constant factor of $\phi(\mathcal{F})$. Let $F = F_i$ be one of the cycles.

Let $j^* := \max_{v \in V[F]} \xi(v)$ be the index of the component with the highest width among the components that F visits. There have to be at least two vertices on F from T_{j^*} (every vertex is a terminal by our assumption, and since the cycles are disjoint, a lone vertex would not be connected to its mate, but \mathcal{F} is a feasible solution). If the two vertices are adjacent in F , then we can delete the edge that connects them and obtain a path that satisfies the preconditions of Lemma 35. We get an edge set F' . Otherwise, let v_1 and v_2 be two vertices from T_{j^*} that are not connected by an edge in F . Then the cycle is partitioned into two paths, both with endpoints v_1 and v_2 , that both satisfy the preconditions of Lemma 35. In this case, we get two solutions F'_l and F'_r and set $F' := F'_l \cup F'_r$. Notice that, either way, we get a set of edges F' on the vertices $V[F]$ inducing connected components F'_1, \dots, F'_x of $F_{\circ} \cup F'$ with the following properties:

1. \mathcal{A} is edge/set swap-optimal with respect to F'
2. For all F'_ℓ , there exists an index j such that $V[F'_\ell] \subseteq V[T_j]$ (thus, $\xi(F'_\ell) = j$). When $F' = F'_l \cup F'_r$, then notice that the connected components of F'_l and F'_r are disjoint with the exception of those containing v_1 and v_2 . Thus, no components with vertices from different T_j will get connected.
3. There is only one F'_ℓ with $\xi(F'_\ell) = j^*$, assume w.l.o.g. that $\xi(F'_1) = j^*$. When $F' = F'_l \cup F'_r$, then notice that all occurrences of vertices from T_{j^*} are connected to v_1 and v_2 in either F'_l or F'_r , thus, they are all in the same connected component of F' .
4. It holds that $d(F') \leq d(F_{\leftrightarrow})$ and $\sum_{\ell=2}^x w(T_{\xi(F'_\ell)}) \leq c \cdot d(F_{\leftrightarrow})$. When $F' = F'_l \cup F'_r$, notice that $d(F') = d(F'_l) + d(F'_r) \leq d(F_{\leftrightarrow})$, and that $\sum_{\ell=2}^x w(T_{\xi(F'_\ell)})$, which does not include the components with v_1 and v_2 , can be split according to the ‘side’ of the cycle that the components belong to.

The solution \mathcal{F}' that arises from substituting F_{\leftrightarrow} by F' is not necessarily feasible because $F_{\circ} \cup F'$ can consist of multiple connected components. We need to transform F' such that all terminal pairs in $F_{\circ} \cup F'$ are connected. Notice that a terminal pair u, \bar{u} always satisfies $\xi(u) = \xi(\bar{u})$ because \mathcal{A} is feasible, i.e., we do not need to connect connected components with vertices from different T_j . Furthermore, all vertices in $V[F]$ from T_{j^*} are already connected because of 3. Fix a $j < j^*$ and consider all connected components F'_ℓ with $\xi(F'_\ell) = j$. Notice that $j < j^*$ implies that the widths of these components are part of $\sum_{\ell=2}^x w(T_{\xi(F'_\ell)})$. Start with an arbitrary F'_ℓ . If there is a terminal $u \in F'_\ell$ whose partner \bar{u} is in $F'_{\ell'}$, $\ell' \neq \ell$, then connect u to \bar{u} . Since $u, \bar{u} \in T_j$, their distance is at most $w(T_j)$. Since $w(T_{\xi(F'_{\ell'})}) = w(T_j)$, the contribution of $F'_{\ell'}$ to the

width sum is large enough to cover the connection cost. Now, F'_ℓ and $F'_{\ell'}$ are merged into one component, we keep calling it F'_ℓ . Repeat the process until all terminals in F'_ℓ are connected to their partner, while always spending a connection cost that is bounded by the contribution of the component that gets merged into F'_ℓ . When F'_ℓ is done, pick a component that was not merged and continue in the same fashion. Repeat until all components are merged or processed. In the end, F' is a feasible solution, and the money spent for the additional edges is bounded by $\sum_{\ell=2}^x w(T_{\xi(F'_\ell)}) \leq c \cdot d(F_{\leftrightarrow})$. Thus, the cost of the new solution is at most $(1 + c) \cdot d(F_{\leftrightarrow})$.

We process all F_i with $F_i \neq (F_i)_\circ$ in this manner to obtain a solution \mathcal{F}' with $\mathcal{F}' = \mathcal{F}'_\circ$. Notice that \mathcal{A} is edge/edge and edge/set swap-optimal with respect to \mathcal{F}' . This holds for the new edges because they are from G and \mathcal{A} is swap-optimal with respect to G , and it holds for the edges that we get from Lemma 35 by property 1.

Thus, we have found \mathcal{F}' with the necessary properties. \square

We can now apply Corollary 2 to bound the cost of \mathcal{A} .

Corollary 37. *Let $G = (V, E)$ be a complete graph, let $d : E \rightarrow \mathbb{R}_{\geq 0}$ be a metric that assigns a cost d_e to every edge $e \in E$ and let $\mathcal{T} \subseteq V \times V$ be a terminal set. Let $\mathcal{A}, \mathcal{F} \subseteq E$ be two feasible Steiner Forest solutions for (G, \mathcal{T}) . Furthermore, suppose that \mathcal{A} is edge/edge, edge/set and path/set swap-optimal with respect to E and ϕ , that \mathcal{A} is c -approximate connecting move optimal and that \mathcal{A} only uses edges between terminals. Then $d(\mathcal{A}') \leq 23(1 + c) \cdot d(\mathcal{F})$.*

Proof. Lemma 36 ensures that there is a solution \mathcal{F}' with $d(\mathcal{F}') \leq 2(1 + c) \cdot d(\mathcal{F})$ that satisfies $\mathcal{F}'_\circ = \mathcal{F}'$. Every connected component A_j of \mathcal{A} can now be treated separately by using Corollary 2 on A_j and the part of \mathcal{F}' that falls into A_j . By combining the conclusions for all connected components, we get that

$$d(\mathcal{A}') \leq 11.5\phi(\mathcal{F}') \leq 23(1 + c) \cdot d(\mathcal{F})$$

for any feasible solution \mathcal{F} . \square

Theorem 1 follows directly. Since the 2-approximation for k -MST [Gar05] can be adapted to the weighted case [Gar16], $c = 2$ is possible and we can achieve an approximation guarantee of 69.

References

- [AFS13] Sara Ahmadian, Zachary Friggstad, and Chaitanya Swamy, *Local-search Based Approximation Algorithms for Mobile Facility Location Problems*, Proceedings of the Twenty-Fourth Annual ACM-SIAM Symposium on Discrete Algorithms, SODA '13, SIAM, 2013, pp. 1607–1621.
- [AGK⁺04] Vijay Arya, Naveen Garg, Rohit Khandekar, Adam Meyerson, Kamesh Munagala, and Vinayaka Pandit, *Local Search Heuristics for k -Median and Facility Location Problems*, SIAM Journal on Computing **33** (2004), no. 3, 544–562.
- [AK00] Sanjeev Arora and George Karakostas, *A $2 + \epsilon$ Approximation Algorithm for the k -MST Problem*, Proceedings of the Eleventh Annual ACM-SIAM Symposium on Discrete Algorithms (David Shmoys, ed.), SODA '00, Society for Industrial and Applied Mathematics, 2000, pp. 754–759.
- [AKR95] Ajit Agrawal, Philip Klein, and R. Ravi, *When Trees Collide: An Approximation Algorithm for the Generalized Steiner problem on Networks*, SIAM Journal on Computing **24** (1995), no. 3, 440–456.
- [Ali94] Paola Alimonti, *New Local Search Approximation Techniques for Maximum Generalized Satisfiability Problems*, Proceedings of the Second Italian Conference on Algorithms and Complexity (Maurizio Bonuccelli, Pierluigi Crescenzi, and Rossella Petreschi, eds.), CIAC '94, Springer-Verlag, 1994, pp. 40–53.

- [AR98] Sunil Arya and H. Ramesh, *A 2.5-factor Approximation Algorithm for the k -MST Problem*, Information Processing Letters **65** (1998), no. 3, 117–118.
- [Big98] Norman Biggs, *Constructions for cubic graphs with large girth*, The Electronic Journal of Combinatorics **5** (1998), no. 1, A1:1–A1:25.
- [BRV96] Avrim Blum, R. Ravi, and Santosh Vempala, *A Constant-factor Approximation Algorithm for the k -MST Problem*, Proceedings of the Twenty-eighth Annual ACM Symposium on Theory of Computing (Gary L. Miller, ed.), STOC '96, ACM, 1996, pp. 442–448.
- [CAKM16] Vincent Cohen-Addad, Philip N. Klein, and Claire Mathieu, *Local search yields approximation schemes for k -means and k -median in euclidean and minor-free metrics*, Proceedings of the 57th Annual Symposium on Foundations of Computer Science, 2016, to appear.
- [CG15] Sergio Cabello and David Gajser, *Simple PTAS's for families of graphs excluding a minor*, Discrete Applied Mathematics **189** (2015), 41–48.
- [CIM09] Chandra Chekuri, Sungjin Im, and Benjamin Moseley, *Longest wait first for broadcast scheduling [extended abstract]*, Approximation and Online Algorithms, Springer, 2009, pp. 62–74.
- [CM15] Vincent Cohen-Addad and Claire Mathieu, *Effectiveness of local search for geometric optimization*, 31st International Symposium on Computational Geometry, SoCG 2015, June 22-25, 2015, Eindhoven, The Netherlands, 2015, pp. 329–343.
- [CRV10] Ho-Lin Chen, Tim Roughgarden, and Gregory Valiant, *Designing network protocols for good equilibria*, SIAM J. Comput. **39** (2010), no. 5, 1799–1832. MR 2592034 (2011d:68012)
- [CRW04] Fabián A. Chudak, Tim Roughgarden, and David P. Williamson, *Approximate k -MSTs and k -Steiner Trees via the Primal-dual Method and Lagrangean Relaxation*, Mathematical Programming **100** (2004), no. 2, 411–421.
- [CS09] Chandra Chekuri and F. Bruce Shepherd, *Approximate Integer Decompositions for Undirected Network Design Problems*, SIAM Journal on Discrete Mathematics **23** (2009), no. 1, 163–177.
- [FHJM94] Matteo Fischetti, Horst W. Hamacher, Kurt Jørnsten, and Francesco Maffioli, *Weighted k -Cardinality Trees: Complexity and Polyhedral Structure*, Networks **24** (1994), no. 1, 11–21.
- [FR94] Martin Fürer and Balaji Raghavachari, *Approximating the minimum-degree steiner tree to within one of optimal*, J. Algorithms **17** (1994), no. 3, 409–423.
- [FRS16] Zachary Friggstad, Mohsen Rezapour, and Mohammad R. Salavatipour, *Local search yields a PTAS for k -means in doubling metrics*, Proceedings of the 57th Annual Symposium on Foundations of Computer Science, vol. abs/1603.08976, 2016, to appear.
- [Gar96] Naveen Garg, *A 3-approximation for the Minimum Tree Spanning K Vertices*, Proceedings of the Thirty-seventh Annual Symposium on Foundations of Computer Science, FOCS '96, IEEE Computer Society, 1996, pp. 302–309.
- [Gar05] ———, *Saving an Epsilon: A 2-approximation for the k -MST Problem in Graphs*, Proceedings of the Thirty-seventh Annual ACM Symposium on Theory of Computing (Ronald Fagin and Hal Gabow, eds.), STOC '05, ACM, 2005, pp. 396–402.
- [Gar16] Naveen Garg, 2016, Personal Communication.
- [GGK13] Albert Gu, Anupam Gupta, and Amit Kumar, *The Power of Deferral: Maintaining a Constant-Competitive Steiner Tree Online*, Proceedings of the Forty-fifth Annual ACM Symposium on Theory of Computing (Dan Bonesh, Joan Feigenbaum, and Tim Roughgarden, eds.), STOC '13, ACM, 2013, pp. 525–534.
- [GK14] Anupam Gupta and Amit Kumar, *Online steiner tree with deletions*, SODA, Jan 2014, pp. 455–467.
- [GK15] Anupam Gupta and Amit Kumar, *Greedy Algorithms for Steiner Forest*, Proceedings of the Forty-seventh Annual ACM Symposium on Theory of Computing (Ronitt Rubinfeld and Rocco Servedio, eds.), STOC '15, ACM, 2015, pp. 871–878.

- [GW95] Michel X. Goemans and David P. Williamson, *A General Approximation Technique for Constrained Forest Problems*, SIAM Journal on Computing **24** (1995), no. 2, 296–317.
- [Hel00] Keld Helsgaun, *An Effective Implementation of the Lin-Kernighan Traveling Salesman Heuristic*, European Journal of Operational Research **126** (2000), no. 1, 106–130.
- [IW91] Makoto Imase and Bernard M. Waxman, *Dynamic Steiner tree problem*, SIAM J. Discrete Math. **4** (1991), no. 3, 369–384. MR 92f:68066
- [Jai01] Kamal Jain, *A Factor 2 Approximation Algorithm for the Generalized Steiner Network Problem*, Combinatorica **21** (2001), no. 1, 39–60.
- [JMP00] David S. Johnson, Maria Minkoff, and Steven Phillips, *The Prize Collecting Steiner Tree Problem: Theory and Practice*, Proceedings of the Eleventh Annual ACM-SIAM Symposium on Discrete Algorithms, SODA '00, Society for Industrial and Applied Mathematics, 2000, pp. 760–769.
- [JV01] Kamal Jain and Vijay V. Vazirani, *Approximation Algorithms for Metric Facility Location and k -Median Problems Using the Primal-dual Schema and Lagrangian Relaxation*, Journal of the ACM **48** (2001), no. 2, 274–296.
- [KLS05] Jochen Könemann, Stefano Leonardi, and Guido Schäfer, *A Group-Strategyproof Mechanism for Steiner Forests*, Proceedings of the Sixteenth Annual ACM-SIAM Symposium on Discrete Algorithms, SODA '05, Society for Industrial and Applied Mathematics, 2005, pp. 612–619.
- [KLSvZ08] Jochen Könemann, Stefano Leonardi, Guido Schäfer, and Stefan H. M. van Zwam, *A Group-Strategyproof Cost Sharing Mechanism for the Steiner Forest Game*, SIAM Journal on Computing **37** (2008), no. 5, 1319–1341.
- [KMN⁺04] Tapas Kanungo, David M. Mount, Nathan S. Netanyahu, Christine D. Piatko, Ruth Silverman, and Angela Y. Wu, *A Local Search Approximation Algorithm for k -means Clustering*, Computational Geometry **28** (2004), no. 2–3, 89–112, Special Issue on the 18th Annual Symposium on Computational Geometry – SoCG2002.
- [KMSV98] Sanjeev Khanna, Rajeev Motwani, Madhu Sudan, and Umesh V. Vazirani, *On Syntactic versus Computational Views of Approximability*, SIAM Journal on Computing **28** (1998), no. 1, 164–191.
- [KPR00] Madhukar R. Korupolu, C. Greg Plaxton, and Rajmohan Rajaraman, *Analysis of a local search heuristic for facility location problems*, J. Algorithms **37** (2000), no. 1, 146–188.
- [LK73] Shen Lin and Brian W. Kernighan, *An Effective Heuristic Algorithm for the Traveling-Salesman Problem*, Operations Research **21** (1973), no. 2, 498–516.
- [LOP⁺15] Jakub Łacki, Jakub Oćwieja, Marcin Pilipczuk, Piotr Sankowski, and Anna Zych, *The Power of Dynamic Distance Oracles: Efficient Dynamic Algorithms for the Steiner Tree*, Proceedings of the Forty-Seventh Annual ACM Symposium on Theory of Computing (New York, NY, USA), STOC '15, ACM, 2015, pp. 11–20.
- [LR96] Hsueh-I Lu and R. Ravi, *The Power of Local Optimization: Approximation Algorithms for Maximum-leaf Spanning Tree*, In Proceedings, Thirtieth Annual Allerton Conference on Communication, Control and Computing, 1996, pp. 533–542.
- [MSVW12] Nicole Megow, Martin Skutella, José Verschae, and Andreas Wiese, *The power of recourse for online MST and TSP*, ICALP (1), 2012, pp. 689–700.
- [PS15] Lukáš Poláček and Ola Svensson, *Quasi-Polynomial Local Search for Restricted Max-Min Fair Allocation*, ACM Transactions on Algorithms **12** (2015), no. 2, 13:1–13:13.
- [PTW01] Martin Pál, Éva Tardos, and Tom Wexler, *Facility location with nonuniform hard capacities*, 42nd Annual Symposium on Foundations of Computer Science, FOCS 2001, 14-17 October 2001, Las Vegas, Nevada, USA, 2001, pp. 329–338.

- [SO98] Roberto Solis-Oba, *2-Approximation Algorithm for Finding a Spanning Tree with Maximum Number of Leaves*, Proceedings of the Sixth Annual European Symposium on Algorithms (Gianfranco Bilardi, Giuseppe F. Italiano, Andrea Pietracaprina, and Geppino Pucci, eds.), ESA '98, Springer Berlin Heidelberg, 1998, pp. 441–452.
- [WS11] David P Williamson and David B Shmoys, *The design of approximation algorithms*, Cambridge university press, 2011.

A Notes on simpler local search algorithms

A.1 Adding an edge and removing a constant number of edges

Let ℓ and $k < \ell$ be integers and consider Figure 22. Notice that adding a single edge and removing k edges does not improve the solution. However, the current solution costs more than ℓ^2/k and the optimal solution costs less than 2ℓ , which is a factor of $\ell/(2k)$ better.

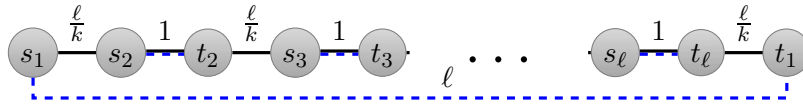

Figure 22: A bad example for edge/set swaps that remove a constant number of edges.

A.2 Regular graphs with high girth and low degree

Assume that G is a degree-3 graph with girth $g = c \log n$ like the graph used in Chen et al. [CRV10]. Such graphs can be constructed, see [Big98]. Select a spanning tree \mathcal{F} in G which will be the optimal solution. Let E' be the non-tree edges, notice that $|E'| \geq n/2$, and let M be a maximum matching in E' . Because of the degrees, we know that $|M| \geq n/10$. The endpoints of the edges in M form the terminal pairs \mathcal{T} . Set the length of all edges in \mathcal{F} to 1 and the length of the remaining edges to $g/4$. The solution \mathcal{F} is feasible and costs $n - 1$. The solution M costs $\Omega(\log n)$.

Assume we want to remove an edge $e = \{v, w\} \in M$ and our swap even allows us to add a path to reconnect v and w (in the graph where $M \setminus \{e\}$ is contracted). Let P be such a path. Since M is a matching, at most every alternating edge on P is in M . Thus, we have to add $|P|/2 - 1 \geq g/2 - 1$ edges of length one at a total cost that is larger than the cost $g/4$ of e . Thus, no d -improving swap of this type exists (note that, in particular, path/set swaps are not d -improving for M). As a consequence, any oblivious local search with constant locality gap needs to sport a move that removes edges from multiple components of the current solution. In order to restrict to local moves that only remove edges from a single component, we therefore introduced the potential ϕ .

B Making the Algorithm Polynomial

So far, we have shown that any locally optimal solution is also within a constant factor of the global optimum. In order to ensure that the local search can find such a local optimum in polynomial time, two issues have to be addressed.

First, we need to show that each improving move can be carried out in polynomial time (or it can be decided in polynomial time that no such move exists). While it is easy to see that improving edge/edge, edge/set, and path/set swaps can be found in polynomial time, finding an improving connecting move is NP-hard in general. However, as we saw in Section 8.1, it is sufficient to restrict the neighborhood of the local search to c -approximate connecting moves. In Section B.1, we show that the task of finding an approximate connecting move reduces to approximating the weighted k -MST problem. In Section B.2 we discuss constant factor approximation algorithms for this problem. In particular, we get the following theorem:

Theorem 38. *Let $\varepsilon > 0$. There exists a polynomial time algorithm, called Improving-Connecting-Move, such that given a Steiner forest \mathcal{A} and a metric distance $d : E \rightarrow \mathbb{R}_{\geq 0}$ on the edges then either: (i) the algorithm finds an improving connecting move with respect to ϕ , or (ii) it guarantees that there is no*

$c(1 + \varepsilon)$ -approximate connecting move, that is, for every tree T of $G_{\mathcal{A}}$ it holds that

$$\sum_{e \in \mathcal{A}} d(e) \geq c(1 + \varepsilon) \cdot \left(\sum_{i \in V_{\mathcal{A}}} w(A_i) - \max_{i \in V_{\mathcal{A}}} w(A_i) \right),$$

where $\{A_1, \dots, A_p\}$ is the set of connected components of \mathcal{A} .

The second thing we need to show for guaranteeing polynomiality of the local search is that the total number of improving moves is bounded by a polynomial in the input size. This can easily be achieved done via a standard rounding technique incurring only a loss of a factor of $1 + \varepsilon$ over the original guarantee for local optima, for an arbitrarily small $\varepsilon > 0$; see Section B.3 for details.

We finally get the following theorem:

Theorem 39. *For every $\varepsilon > 0$, there is a local search algorithm that computes in polynomial time a solution \mathcal{A} to Steiner Forest such that $d(\mathcal{A}) \leq (1 + \varepsilon)69 \cdot OPT$.*

B.1 How to ensure approximate connecting move optimality

Assume that we are given an algorithm *Tree-Approx* that computes a c -approximation for the following minimization problem. We call the problem *weighted (rooted) k -MST problem*, and approximating it is further discussed in Section B.2.

Given $G = (V, E)$ with a root r , a metric $d : V \times V \rightarrow \mathbb{R}^+$, a function $\gamma : V \rightarrow \mathbb{R}^+$ with $\gamma(r) = 0$, and a lower bound Γ , find a tree T in G with $r \in V[T]$ and $\sum_{v \in V[T]} \gamma(v) \geq \Gamma$ that minimizes $\sum_{e \in T} d(e)$.

We see how to use *Tree-Approx* to ensure $((1 + \varepsilon) \cdot c)$ -approximate connecting move optimality. We apply *Tree-Approx* to $G_{\mathcal{A}}^{\text{all}}$. Recall that the vertices in $G_{\mathcal{A}}^{\text{all}}$ are $\{1, \dots, p\}$, corresponding to the components A_1, \dots, A_p of our solution. We try $|V(G_{\mathcal{A}}^{\text{all}})|$ possibilities for the component with the largest width in the connecting move. After choosing the largest component to be the one with index i , we delete all vertices from $G_{\mathcal{A}}^{\text{all}}$ with indices larger than i . Then we set $\gamma(i) := 0$ and $\gamma(j) := w(A_j)$ for $j < i$. We can collect prices between $w_{\min} := \min\{w(A_i) \mid i \in \{1, \dots, p\}, w(A_i) > 0\}$, the smallest strictly positive width of any component, and $\sum_{j=1}^{i-1} w(A_j) < p \cdot w(A_p)$. We call *Tree-Approx* for $\Gamma = (1 + \varepsilon/2)^\ell w_{\min}$ for all $\ell \geq 1$ until $(1 + \varepsilon/2)^\ell \geq p w(A_p)$. The largest ℓ that we have to test is at most $\log_{1+\varepsilon/2} p \frac{w(A_p)}{w_{\min}}$. Thus, our total number of calls of *Tree-Approx* is bounded by $p \cdot \log_{1+\varepsilon/2} p \frac{w(A_p)}{w_{\min}} \leq n \cdot \log_{1+\varepsilon/2} n \Delta$, where Δ is the largest distance between a terminal and its partner divided by the smallest such distance that is non-zero.

Assume that *Tree-Approx* returns a solution T with $\sum_{e \in E[T]} d(e) > \sum_{v \in T} \gamma(v)$ for all calls, which means that it does not find an improving connecting move. Furthermore, assume that there exists a $((1 + \varepsilon) \cdot c)$ -approximate connecting move T^* that we should have found, i.e., which satisfies that $\sum_{e \in E[T^*]} d(e) \leq \frac{1}{(1+\varepsilon)c} \sum_{v \in T^*} \gamma(v)$. Set $\Gamma^* := \sum_{v \in T^*} \gamma(v)$. Let ℓ be the index that satisfies $(1 + \varepsilon/2)^\ell w_{\min} \leq \Gamma^* < (1 + \varepsilon/2)^{\ell+1} w_{\min}$ and consider the run with the correct choice of the largest width and the lower bound $\Gamma' := (1 + \varepsilon/2)^\ell w_{\min}$.

Notice that T^* is a feasible solution for this run: $w(T^*) = \Gamma^* \geq \Gamma'$ satisfies the lower bound. Thus, the optimal solution to the input has a cost of at most $\sum_{e \in E[T^*]} d(e)$. *Tree-Approx* computes a c -approximation,

i.e., a solution \hat{T} with $\sum_{v \in V[\hat{T}]} \gamma(v) \geq \Gamma'$ and

$$\begin{aligned} \sum_{e \in \hat{T}} d(e) &\leq c \sum_{e \in E[T^*]} d(e) \leq \frac{c}{(1 + \varepsilon)c} \sum_{v \in V[T^*]} \gamma(v) \\ &\leq (1 + \varepsilon/2) \frac{c}{(1 + \varepsilon)c} \Gamma' < \Gamma' \leq \sum_{v \in V[\hat{T}]} \gamma(v), \end{aligned}$$

which means that *Tree-Approx* computes an improving connecting move.

B.2 Weighted k -MST

This section is about ways to provide the algorithm *Tree-Approx*. The problem we want to solve is a weighted version of the *rooted k -MST problem*. Given $G = (V, E)$ with a root r , a metric $d : V \times V \rightarrow \mathbb{R}^+$ and a lower bound $k \in \mathbb{N}$, the rooted k -MST problem is to compute a tree T in G with $r \in V[T]$ and $|V[T]| \geq k$ that minimizes $\sum_{e \in E[T]} d(e)$. The unrooted k -MST problem is defined verbatim except that no distinguished root has to be part of the tree.

Work on k -MST. Fischetti et al. [FHJM94] show that the unrooted k -MST problem is NP-hard. Any algorithm for the rooted k -MST problem transfers to an algorithm for the unrooted case with the same approximation guarantee by testing all possible nodes and returning the best solution that was found. This in particular holds for optimal algorithms, so the rooted k -MST problem is also NP-hard.

As for example observed by Garg [Gar05], we can also use algorithms for the unrooted k -MST problem to compute solutions for the rooted k -MST problem with the same approximation guarantee. To do so, create n vertices with zero distance to the designated root vertex and search for a tree with $n + k$ vertices. Any such tree has to include at least one copy of the root, and at least $k - 1$ other vertices. Thus, any solution for the unrooted k -MST problem is a feasible solution for the rooted k -MST problem, and the cost is the same. Thus, the rooted and unrooted version of the k -MST problem are equivalent.

Blum, Ravi and Vempala [BRV96] develop the first constant-factor approximation for the k -MST problem, the factor is 17. Subsequently, Garg [Gar96] gave a 3-approximation, Arya and Ramesh [AR98] developed a 2.5-approximation, Arora and Karakostas [AK00] proposed a $(2 + \varepsilon)$ -approximation, and, finally, Garg [Gar05] published a 2-approximation algorithm for the k -MST problem. Chudak, Roughgarden and Williamson [CRW04] show that an easier 5-approximation also proposed by Garg [Gar96] bears resemblances to the primal dual algorithm by Jain and Vazirani [JV01] for the k -median problem, in particular to the utilization of Lagrangean relaxation.

Connection to weighted k -MST. Johnson, Minkoff and Phillips [JMP00] observe the following reduction from the weighted k -MST problem to the unweighted k -MST problem, assuming all $\gamma(v)$ are integers. To create the unweighted instance $G' = (V', E')$, start with $V' = V$. Then, for any vertex v , add $2\gamma(v)n - 1$ vertices at distance zero of v (thus, there are $2\gamma(v)n$ vertices ‘at’ v), and set k to $2n\Gamma$. Any solution T for the weighted k -MST problem can be interpreted as a solution T' for the modified unweighted instance with $\sum_{v \in V[T]} 2n\gamma(v) = 2n\Gamma$ vertices. Given a solution for the unweighted input, we can first change the solution thus that for any $v \in V$, either $v' \in V'$ is not picked or v' is picked and its $2\gamma(v)n - 1$ copies are picked as well. This is possible since picking more vertices at the same location incurs no additional cost. After this step, the solution can be transformed into a weighted solution with enough weight by picking the corresponding vertices in V .

This reduction constructs an input for the unweighted k -MST problem that is of pseudo-polynomial size. Johnson et al. [JMP00] note that algorithms for the unweighted k -MST problem can typically be adapted to handle the clouds of vertices at the same location implicitly without incurring a super-polynomial running

time. They specifically state that this is true for the 3-approximation algorithm by Garg [Gar96] for the rooted k -MST problem. The more recent 2-approximation algorithm by Garg [Gar05] can also be adapted for the weighted case such that the running time remains independent of the weights [Gar16]. This yields a polynomial 2-approximation algorithm for weighted k -MST.

B.3 Convergence

It is easy to see that a straightforward execution of the local search algorithm discussed in this paper runs in pseudo-polynomial time, as each improving move decreases the potential at least by the length of the shortest edge. We apply a standard rounding technique to make the algorithm polynomial.

Algorithm X

1. Set $i := 0$ and let $\mathcal{A}_0 = \mathfrak{T}$.
2. $\beta := \frac{\varepsilon \cdot \max_{\{v, \bar{v}\} \in \mathfrak{T}} d(v, \bar{v})}{|E|}$, $d_\beta(e) := \left\lceil \frac{d(e)}{\beta} \right\rceil \beta$.
3. While \mathcal{A}_i admits an improving path/set swap w.r.t to ϕ_β , or *Improving-Connecting-Move* finds an improving connecting move w.r.t. ϕ_β , set \mathcal{A}_{i+1} to be the resulting solution after applying the move, and $i := i + 1$.
4. Return the solution \mathcal{A}' obtained by dropping all inessential edges of \mathcal{A}_i .

Lemma 40. *Assuming that the locality gap for swap-optimal and c -approximate connecting move optimal solutions is C , Algorithm X computes in polynomial time a $(1 + \varepsilon)C$ -approximation to Steiner Forest.*

Proof. We first observe that the algorithm runs in polynomial time. To see this, first note that $d_\beta(e) \geq \beta$ for all $e \in E$. Therefore, every improving path/set swap and every successful run of *Improving-Connecting-Move* decreases the potential by at least β , i.e., $\phi_\beta(\mathcal{A}_{i+1}) \leq \phi_\beta(\mathcal{A}_i) - \beta$. As $\phi_\beta(\mathcal{A}_0) = 2 \sum_{\{v, \bar{v}\} \in \mathfrak{T}} d_\beta(v, \bar{v}) \leq \frac{2n_t|E|}{\varepsilon} \beta$, we conclude that the algorithm terminates after at most $2 \frac{n_t|E|}{\varepsilon}$ iterations, each of which can be executed in polynomial time.

Now consider the output \mathcal{A}' of Algorithm X. As it is path/set swap optimal and c -approximately connecting move optimal w.r.t. d_β , our assumption on the locality gap implies that $d_\beta(\mathcal{A}') \leq C d_\beta(\mathcal{F}_\beta)$, where \mathcal{F}_β is the optimal solution of the Steiner Forest instance defined by the metric d_β . Furthermore $d_\beta(\mathcal{F}_\beta) \leq d_\beta(\mathcal{F})$, where \mathcal{F} is an optimal solution to the original Steiner Forest instance defined by the metric d . We hence observe that

$$\begin{aligned} d(\mathcal{A}') &\leq d_\beta(\mathcal{A}') \leq C d_\beta(\mathcal{F}_\beta) \leq C d_\beta(\mathcal{F}) = C \cdot \sum_{e \in \mathcal{F}} \left\lceil \frac{d(e)}{\beta} \right\rceil \beta \\ &\leq C \cdot \sum_{e \in \mathcal{F}} \left(\frac{d(e)}{\beta} + 1 \right) \beta \leq C \cdot (d(\mathcal{F}) + |\mathcal{F}| \beta) \leq (1 + \varepsilon)C \cdot d(\mathcal{F}), \end{aligned}$$

where the last inequality follows from $|\mathcal{F}| \leq |E|$ and $d(\mathcal{F}) \geq \max_{\{v, \bar{v}\} \in \mathfrak{T}} d(v, \bar{v})$. \square

Note that Corollary 37 asserts that we can choose $C = 23(1 + c)$, and [Gar05, Gar16] yields that $c = 2$ is a feasible choice. Thus Lemma 40 yields a polynomial-time $(1 + \varepsilon) \cdot 69$ -approximation local search algorithm, proving Theorem 1.