

Finding AND-OR Hierarchies in Workflow Nets

Jacek Sroka
Institute of Informatics
University of Warsaw, Poland
sroka@mimuw.edu.pl

Jan Hidders
Vrije Universiteit Brussel, Belgium
jan.hidders@vub.ac.be

Abstract

This paper presents the notion of AND-OR reduction, which reduces a WF net to a smaller net by iteratively contracting certain well-formed subnets into single nodes until no more such contractions are possible. This reduction can reveal the hierarchical structure of a WF net, and since it preserves certain semantical properties such as soundness, it can help with analysing and understanding why a WF net is sound or not. The reduction can also be used to verify if a WF net is an AND-OR net. This class of WF nets was introduced in earlier work, and arguably describes nets that follow good hierarchical design principles. It is shown that the AND-OR reduction is confluent up to isomorphism, which means that despite the inherent non-determinism that comes from the choice of subnets that are contracted, the final result of the reduction is always the same up to the choice of the identity of the nodes. Based on this result, a polynomial-time algorithm is presented that computes this unique result of the AND-OR reduction. Finally, it is shown how this algorithm can be used to verify if a WF net is an AND-OR net.

1 Introduction

Petri nets [16] are one of the most popular and well studied formalisms for modeling processes. Their graphical notation is easy to understand, but at the same time concrete and formal, which allows for reasoning over the complex systems that are being modeled. Petri nets are especially useful for business processes and business workflows for which a specific class of Petri nets, called *workflow nets*, was introduced [24, 25]. Even though other notations are used in most industrial process modeling tools like Business Process Modeling Notation (BPMN) [15], Business Process Execution Language (BPEL) or Event-driven Process Chain (EPC) [11], the control flow aspect of the models expressed in those notations can be translated to workflow nets. At the same time workflow

nets are considered to be the goto formalism for workflow analysis, like detecting possible problems, e.g., existence of deadlocks or livelocks, and for investigating the principles of workflow modeling without focusing on a particular language.

Workflow models that lack those problems are called *sound*, and the first definition of workflow-net soundness was proposed by van der Aalst in [24]. Quickly several alternative definitions of soundness, varying in strictness and verification difficulty, emerged. Examples of these are weak soundness [12, 13], relaxed soundness [6], lazy soundness [18], k -soundness and generalised soundness [29, 28], up-to- k -soundness [27] and substitution soundness [20]. Informally, the original notion of soundness guarantees two properties of the net. First, that if we initiate the workflow net correctly, then no matter how the execution proceeds, we can always end up in a proper final state. Second, that every subtask can be potentially executed in some run of the workflow. An overview of the research on the different types of soundness of workflow nets and their decidability can be found in [26].

In earlier research [20] we have proposed a new notion of soundness, namely the substitution soundness or sub-soundness for short. It is similar to k - and *-soundness studied in [29], but captures exactly the conditions necessary for building complex workflow nets by following a structured approach where subsystems with multiple inputs and outputs are used as building blocks of larger systems. As was shown in that research, it is not enough for such subsystems to be classically sound by themselves. It may be the case, for example, that if a sound WF net is used inside another sound WF net, that the nested WF net is used to execute several simultaneous computations which can interfere and cause the whole WF net to become unsound. Or it can be that partial results, represented by tokens in the output places of the nested WF net, are consumed prematurely by the containing WF net before the nested WF net has finished properly. This is prevented by the notion of substitution soundness (or sub-soundness), which is informally defined as follows: a WF net is sub-sound iff after initiating it with k tokens in every input place and letting it execute it will always be able to finish by producing k tokens for every output place even if during the run the output tokens are removed by some external transitions.

Although stronger soundness properties may be desirable, they are often also more difficult to verify. For this reason, a method is introduced in [20] for systematically constructing workflow nets so that they are guaranteed to satisfy the sub-soundness property. This method is in principle, and in effect, similar to methods employed in software engineering, where complexity is tackled by separation of concerns and encapsulation, and systems are divided into building blocks such as modules, objects and functions, which in turn can be decomposed further.

We follow those good practices in the context of workflow nets where they, like in software engineering, allow to avoid common pitfalls. Similarly to general programming languages, also for workflow nets, patterns and anti-patterns have been published [25, 22]. Also similarly to general programming, it is beneficial to organise the workflow models in a structured way. In programming the ideas of using macros, subroutines, procedures, functions, and later on, classes, proved

that even extremely complex systems can be programmed and maintained in a practical and effective manner. Such structuring was successfully applied to designing complex Petri nets [33, 21, 7, 1, 8, 17] and workflow nets [2, 23, 20]. As with general programming, the system is composed of small, separated fragments, which are easier to understand and maintain. Fragments can include invocations of other fragments, which can include other nested fragments, and so on.

The class of nets we introduced in [20] is called the class of AND-OR nets (see Section 3). This class is larger and more general than other classes of workflow nets generated with a similar type of structural approach, as presented for example in [29, 2]. Apart from studying conditions necessary for structured workflow systems to be $*$ -sound, it was shown in [20] that all AND-OR nets indeed are sub-sound. In this paper we continue this line of research and introduce a method to determine the hierarchical structure of a WF net, or parts of it, that was not necessarily designed in such a structured way. In [20] the AND-OR nets were defined as all the nets that can be constructed with a top-down refinement procedure, by using nets of certain basic classes similar to S/T systems. In this paper we show that at the same time AND-OR nets that were not necessarily constructed in such a way, can be analysed to determine a refinement hierarchy with a bottom-up reduction procedure that contracts subnets of the basic AND-OR classes. Moreover, it is shown that finding occurrences of such subnets can be done in polynomial time.

A key result in this paper is that the procedure of contracting subnets of the basic AND-OR classes is confluent and therefore the reduction will always return the same result, independent of how the subnets were selected for contraction. It is shown in this paper that this can be used to turn the procedure into a polynomial algorithm and therefore a tractable method for determining an AND-OR refinement tree. Next to that, it can also be determined if a net is an AND-OR by checking if the reduction procedure reduces it to a one-node WF net. If a net is positively identified as an AND-OR net, it is consequently also guaranteed to be $*$ -sound and sub-sound¹, i.e., can be used as a building block of larger systems. A first example of an application of this result would be a scenario where a process modeller constructs a complex model from submodels published in some repository. He or she may want to make sure that the submodels follow good design principles and are sub-sound, which means that they can be safely used as building blocks of a composite model. The repository can contain models for subunits in some organisational structure, e.g., models for faculties of an university or departments of a company or even models from some global repository of socially shared workflows, which appear in e-science [5].

The reduction algorithm can not only be used for AND-OR nets, but also for the analysis of $*$ -soundness and sub-soundness of general workflow nets. It can help the user with finding problems causing unsoundness. More concretely, if the result of AND-OR verification is negative, then the reduction algorithm

¹It follows straightforwardly from the definitions of $*$ -soundness and sub-soundness that the latter implies the first.

stops without reaching a one-node WF net. This resulting net can serve as a condensed version of the original net and point the user to the source of the problem in the design. Note that a WF net may be not an AND-OR net, but still be *-sound or sub-sound. We conjecture, but have not proven, that to verify *-soundness or sub-soundness of an arbitrary net, it is enough to verify *-soundness or sub-soundness of the net resulting from AND-OR verification procedure. The contractions used in our algorithm would have to be proven to preserve *-soundness or sub-soundness, similarly as for example rules of [14] preserve liveness and boundedness. This would give a symmetric and probably similarly laborious result to [20], where it was shown that substitutions of AND-OR nets into AND-OR nets preserve sub-soundness, from which it follows that they also preserve *-soundness. The reduced net, resulting from AND-OR net verification procedure, could then undergo a proper soundness verification with similar methods as in [31, 32]. Furthermore, limiting the size of the verified net with hierarchical methods can be helpful for users struggling with understanding the reasons for unsoundness of workflow nets. That this is often a problem, even when using automated verification tools, is for example reported in [9].

Finally, as a byproduct of a successful reduction, a tree structure describing the nesting of the fragments of the net can be determined. As with similar methods [2, 4, 3], which deal with workflow net class which is a proper subclass of AND-OR nets, such a tree structure can be used for modeling recovery regions or determining sound markings, or just for better understanding the structure of the workflow net and its properties. The latter can for example help with determining how parts of the workflow can best be distributed to independent organisational units or to different servers in case of workflows representing computations, e.g., as in scientific workflows.

In related work [30] a set of heuristics was proposed to find appropriate decomposition boundaries, which results in a refinement tree for a given graph. Our approach, however concentrates specifically on workflow nets which are generalised to allow multiple inputs and outputs, and it is closely tied in a well understood manner to their semantics and soundness properties.

The outline of the remainder of this paper is as follows. In Section 2 the basic terminology of WF nets and their semantics is introduced. In Section 3 the class of AND-OR nets is introduced, based on the notions of place and transition substitution, where a node is replaced with a WF net. In Section 4 the notion of AND-OR reduction is introduced, which is based on the notion of contraction, where certain well-formed subnets of WF nets are contracted into single nodes. It is discussed here how this reduction process is confluent in that it returns a unique result up to the choice of the identity of the nodes. This is based on the observation that the process is locally confluent, but since the proof of this observation is quite involved, it is presented separately in Section 5. In Section 6 a concrete polynomial algorithm for computing the result of the AND-OR reduction is presented, and it is shown how it can be used to verify if a WF net is an AND-OR net. Finally, in Section 7 a summary of the results is given, and potential future research directions are discussed.

2 Basic terminology and definitions

Let S be a set. A bag (multiset) m over S is a function $m : S \rightarrow \mathbb{N}$. We use $+$ and $-$ for the sum and the difference of two bags and $=, <, >, \leq, \geq$ for comparisons of bags, which are defined in the standard way. We overload the set notation, writing \emptyset for the empty bag and \in for the element inclusion. We list elements of bags between brackets, e.g. $m = [p^2, q]$ for a bag m with $m(p) = 2$, $m(q) = 1$, and $m(x) = 0$ for all $x \notin \{p, q\}$. The shorthand notation $k.m$ is used to denote the sum of k bags m . The size of a bag m over S is defined as $|m| = \sum_{s \in S} m(s)$.

Definition 1 (Petri net). A *Petri net* is a tuple $N = (P, T, F)$ where P is a finite set of places, T is a finite set of transitions such that $P \cap T = \emptyset$ and $F \subseteq (T \times P) \cup (P \times T)$ the set of flow edges.

We will refer to the elements of $P \cup T$ also as *nodes* in Petri net. We say that the *type* of a node is *place* or *transition* if it is in P or T , respectively.

A path in a net is a non-empty sequence (n_1, \dots, n_m) of nodes where for all i such that $1 \leq i \leq m-1$ it holds that $(n_i, n_{i+1}) \in F$. Markings are states (configurations) of a net and the set of markings of $N = (P, T, F)$ is the set of all bags over P and is denoted as \mathbf{M}_N . Given a transition $t \in T$, the preset $\bullet t$ and the postset $t \bullet$ of t are the sets $\{p \mid (p, t) \in F\}$ and $\{p \mid (t, p) \in F\}$, respectively. In a similar fashion we write $\bullet p$ and $p \bullet$ for pre- and postsets of places, respectively. To emphasise the fact that the preset (postset) is considered within some net N , we write $\bullet_N a$, $a \bullet_N$. We overload this notation by letting $\bullet a$ ($a \bullet$) also denote the bags of nodes that (1) contain all nodes in the preset (postset) of a exactly once and (2) contains no other nodes. A transition $t \in T$ is said to be enabled at marking m iff $\bullet t \leq m$. For a net $N = (P, T, F)$ with markings m_1 and m_2 and a transition $t \in T$ we write $m_1 \xrightarrow{t}_N m_2$, if t is enabled at m_1 and $m_2 = m_1 - \bullet t + t \bullet$. For a sequence of transitions $\sigma = (t_1, \dots, t_n)$ we write $m_1 \xrightarrow{\sigma}_N m_{n+1}$, if $m_1 \xrightarrow{t_1}_N m_2 \xrightarrow{t_2}_N \dots \xrightarrow{t_n}_N m_{n+1}$, and we write $m_1 \xrightarrow{*}_N m_{n+1}$, if there exists such a sequence $\sigma \in T^*$. We will write $m_1 \xrightarrow{t} m_2$, $m_1 \xrightarrow{\sigma} m_{n+1}$ and $m_1 \xrightarrow{*} m_{n+1}$, if N is clear from the context.

We now introduce the notion of Workflow net, which is a Petri net where certain places and transitions are marked as input and output nodes.

Definition 2 (I/O net). An *I/O net* is a tuple $N = (P, T, F, I, O)$ where (P, T, F) is a Petri net with a non-empty set $I \subseteq P \cup T$ of *input places* and a non-empty set $O \subseteq P \cup T$ of *output places*.

In our setting we will restrict ourselves to I/O nets where input and output nodes are either all places, or all transitions.

Definition 3 (I/O consistent I/O net). An I/O net $N = (P, T, F, I, O)$ is called *I/O consistent* if $I \cup O \subseteq P$ or $I \cup O \subseteq T$.

As is usual for Petri nets that model workflows, we will also require that all nodes in the net can be reached from an input node, and from all nodes in the net an output node can be reached.

Definition 4 (Well-connected I/O net). An I/O net $N = (P, T, F, I, O)$ is called *well-connected* if (1) every node in $P \cup T$ is reachable by a path from at least one node in I and (2) from every node in $P \cup T$ we can reach at least one node in O .

The formal definition of Workflow net is then as follows.

Definition 5 (Workflow net). A *workflow net* (WF net) is a I/O net $N = (P, T, F, I, O)$ that is I/O consistent and well-connected.

If $I \cup O \subseteq P$, then we call N a *place workflow net* (pWF net), and if $I \cup O \subseteq T$, then a *transition workflow net* (tWF net). The *I/O type* of a WF net is the type of its input and output nodes, i.e., it is *place* if it is pWF net, and *transition* if it is a tWF net.

Note that input places can have incoming edges in a workflow net, and that output places can have outgoing edges. We will refer to the nodes in $I \cup O$ as the *interface nodes* of the net. We will call a workflow net a *one-input* workflow net if I contains one element, and a *one-output* workflow net if O contains one element. Often, as in [24], workflow nets are restricted to one-input one-output place workflow nets. We generalise this in two ways: first by allowing also nets with input and output transitions rather than input and output places, and second by allowing multiple input and output places/transitions. For these generalised workflow nets we define the corresponding one-input one-output pWF net as follows. The *place-completion* of a tWF net $N = (P, T, F, I, O)$ is denoted as $\mathbf{pc}(N)$ and is a one-input one-output pWF net that is constructed from N by adding places p_i and p_o such that $p_i \bullet = I$ and $\bullet p_o = O$ and setting the input set and output set as $\{p_i\}$ and $\{p_o\}$, respectively. This is illustrated in Figure 1 (a). In such diagrams we will indicate nodes in I with an unconnected incoming arrow and nodes in O with an unconnected outgoing arrow. The *transition-completion* of a pWF net $N = (P, T, F, I, O)$ is denoted as $\mathbf{tc}(N)$ and is a one-input one-output tWF net that is constructed from N by adding transitions t_i and t_o such that $t_i \bullet = I$ and $\bullet t_o = O$ and setting the input set and output set as $\{t_i\}$ and $\{t_o\}$, respectively. This is illustrated in Figure 1 (b).

In this paper we discuss a particular kind of soundness, namely the soundness that guarantees the reachability of a proper final state [20]. We generalise this for the case where (1) there can be more than one input place and (2) these contain one or more tokens in the initial marking. We also provide a generalisation of soundness for tWF nets, which intuitively states that after k firings of all input transitions the computation can end in an empty marking while firing each of the output transitions exactly k times.

Definition 6 (k and $*$ -soundness). A pWF net $N = (P, T, F, I, O)$ is said to be k -*sound* if for each marking m such that $k.I \xrightarrow{*} m$ it holds that $m \xrightarrow{*} k.O$.

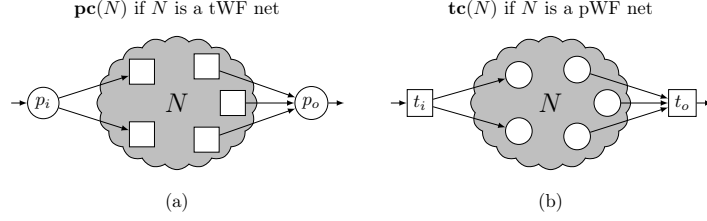

Figure 1: A place-completed tWF net and transition-completion pWF net (from [20])

We call N **-sound* if it is k -sound for all $k \geq 1$. We say that these properties hold for tWF net N if they hold for $\mathbf{pc}(N)$.

By definition place-completion does not affect the **-soundness*. However, as we observed in [20, 19], for transition-completion this is only true in one direction as every pWF net N is **-sound* if $\mathbf{tc}(N)$ is **-sound* but not vice versa.

3 Definition of AND-OR nets

In this section we introduce the AND-OR nets and show that they are **-sound*. For that we recall some definitions and a result from [20, 19] where we defined a method for constructing complex nets by substituting their nodes with other nets - places by pWF nets and transitions by tWF nets.

Definition 7 (Place substitution, Transition substitution). Consider two *disjoint* WF nets N and M , i.e., if $N = (P, T, F, I, O)$ and $M = (P', T', F', I', O')$, then $(P \cup T) \cap (P' \cup T') = \emptyset$.

Place substitution: If p is a place in N and M is a pWF net, then we define the result of substituting p in N with M , denoted as $N \otimes_p M$, as the net that is obtained if in N we remove p and the edges in which it participates and replace it with the net M and edges such that $\bullet p' = \bullet p$ for each input place $p' \in I'$ of M and $p' \bullet = p \bullet$ for each output place $p' \in O'$ of M . If $p \in I$ then p is replaced in the set of input nodes of the resulting net with I' , i.e., the input set of $N \otimes_p M$ is $(I \setminus \{p\}) \cup I'$, and if $p \in O$ then p is replaced in the set of output nodes of the resulting net with O' , i.e., the output set of $N \otimes_p M$ is $(O \setminus \{p\}) \cup O'$. Otherwise, the input and output sets of $N \otimes_p M$ are the same as the respective sets for N .

Transition substitution: Likewise, if t is a transition in N and M is a tWF net, then we define the result of substituting t in N with M , denoted as $N \otimes_t M$, as the net that is obtained if in N we remove t and the edges in which it participates and replace it with the net M and edges such that $\bullet t' = \bullet t$ for each input transition $t' \in I'$ of M and $t' \bullet = t \bullet$ for each output transition $t' \in O'$ of M . If $t \in I$ then t is replaced in the set of input nodes of the resulting net with

I' , i.e., the input set of $N \otimes_t M$ is $(I \setminus \{t\}) \cup I'$, and if $t \in O$ then t is replaced in the set of output nodes of the resulting net with O' , i.e., the output set of $N \otimes_t M$ is $(O \setminus \{t\}) \cup O'$. Otherwise, the input and output sets of $N \otimes_t M$ are the same as the respective sets for N .

The results of a place substitution and transition substitution are illustrated in Figure 2 (a) and (b), respectively. It is not hard to see that for all WF nets N and M and n a node in N such that $N \otimes_n M$ is defined, it is again a WF net. It also holds for all WF nets A, B and C that $(A \otimes_n B) \otimes_m C = A \otimes_n (B \otimes_m C)$, and $(A \otimes_n B) \otimes_m C = (A \otimes_n C) \otimes_m B$ if n and m are different nodes in A .

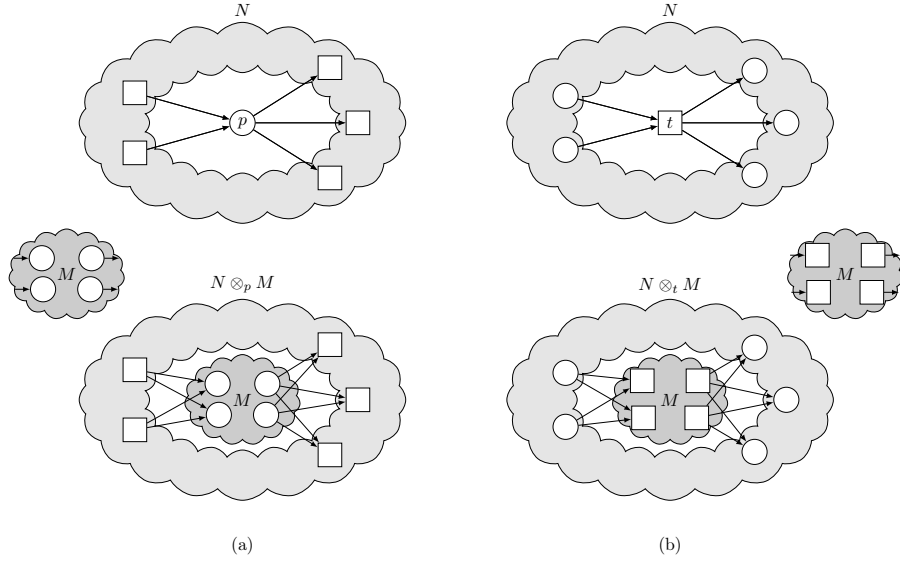

Figure 2: Illustration of place substitution and transition substitution (adapted from [20])

We will generate nets by starting from some basic classes of nets and allowing substitutions of places with pWF nets and transitions with tWF nets.

Definition 8 (Substitution closure). Given a class C of nets we define the substitution closure of C , denoted as $\mathbf{S}(C)$, as the closure of C under transition substitution and place substitution, i.e., the smallest superclass $\mathbf{S}(C)$ of C that satisfies the following two rules for every two disjoint nets N and M in $\mathbf{S}(C)$:

- (1) if M is a pWF net and p a place in N then $N \otimes_p M$ is a net in $\mathbf{S}(C)$ and
- (2) if M is a tWF net and t a transition in N then $N \otimes_t M$ is a net in $\mathbf{S}(C)$.

The motivation for using the concept of substitution closure to define interesting classes of nets is that it makes it straightforward to show for such a class that its nets have a certain property, such as a certain kind of soundness,

by showing that (1) this property holds for the nets in the initial class and (2) this property is preserved by substitution. As was argued in earlier work [20], *-soundness is not preserved by substitution, but substitution does preserve a stronger property called *substitution soundness*. The intuition behind this notion of soundness is that the execution of a net, when started with the same number of tokens in all input places, should always be able to finish properly, even if the execution is interfered with by removing at some step an identical number of tokens from all output places. More precisely, if we start the net if k tokens in all its input places, and somewhere during the execution remove k' tokens from all the output places, then the net should be able to finish with $k - k'$ tokens in its output places.

Definition 9 (substitution soundness). A pWF net $N = (P, T, F, I, O)$ is said to be *substitution sound* if for all $0 \leq k' \leq k$ and every marking m' of N such that $k.I \xrightarrow{*} m' + k'.O$ it holds that $m' \xrightarrow{*} (k - k').O$. A tWF net is said to be substitution sound if its place-completion is substitution sound.

The choice for the initial classes is made such that these are indeed substitution sound. Their intuition is based on that of acyclic marked graphs (T-nets) and state machines (S-nets), as considered in [29]. The basic idea of T-nets is that during executions no choices are made about who consumes a token and each transition will fire in the execution of a workflow. This is captured by a syntactic restriction that says that places have exactly one incoming edge and one outgoing edge. We will call this the *AND-property* of a WF net.

Definition 10 (AND property). A WF net $N = (P, T, F, I, O)$ is said to have the *AND property* if for every place $p \in P$ it holds that (1) $p \in I \wedge |\bullet p| = 0$ or $p \notin I \wedge |\bullet p| = 1$ and (2) $p \in O \wedge |p \bullet| = 0$ or $p \notin O \wedge |p \bullet| = 1$.

Note that in this definition being an input node is considered equivalent to having an extra incoming edge, and being an output node equivalent to having an extra outgoing edge.

The basic idea of S-nets is that they represent a state machine, with the state represented by a single token that is in one of the places. This is captured by a restriction that says that transitions have exactly one incoming edge and one outgoing edge. We will call this the *OR-property* of a net.

Definition 11 (OR property). A WF net $N = (P, T, F, I, O)$ is said to have the *OR property* if for every transition $t \in T$ it holds that (1) $t \in I \wedge |\bullet t| = 0$ or $t \notin I \wedge |\bullet t| = 1$ and (2) $t \in O \wedge |t \bullet| = 0$ or $t \notin O \wedge |t \bullet| = 1$.

Although all WF nets with the OR property are substitution sound, it is unfortunately not the case that all WF nets with the AND property are substitution sound. Consider for example an AND net containing a transition t with a loop containing a place p . Note that because of the AND property place p can have no other edges except those of the loop. Therefore, the transition t can never fire, since that would require a token in p , but such a token can only be generated by firing t . To remedy this, we will define AND nets as WF nets

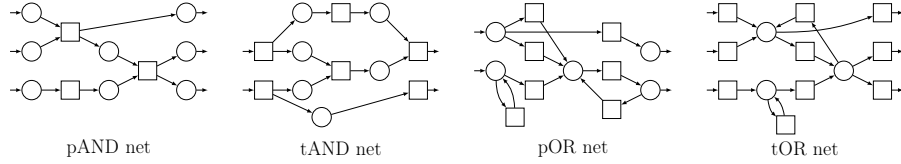

Figure 3: Examples of a pAND, tAND, pOR and tOR nets (adapted from [20])

that not only satisfy the AND property but are also acyclic, which leads to the following definitions of AND and OR nets.

Definition 12 (AND net). An *AND net* is an acyclic WF net that satisfies the AND property. An AND net that is a pWF net is called a pAND net, and if it is a tWF net it is called a tAND net.

Definition 13 (OR net). An *OR net* is a WF net that satisfies the OR property. An OR net that is a pWF net is called a pOR net, and if it is a tWF net it is called a tOR net.

For some examples of AND and OR nets see Figure 3. We will use names to identify the classes of nets we have just defined. The classes of pOR nets, pAND nets, tOR and tAND nets will be denoted as **pOR**, **pAND**, **tOR** and **tAND**. In addition we will prefix the name with **11** if the class contains only nets with one input node and one output node. So **11pOR** is the class of one-input one-output pOR nets, and **11tAND** is the class of one-input one-output tAND nets.

Since our aim is to generate substitution sound nets, which as we will show are also *-sound, we will restrict the tAND nets to one-input one-output nets, so the class **11tAND**. The reason is that although all pAND nets are substitution sound, it is not true that all tAND nets are substitution sound, as is illustrated by the tAND net in Figure 3. Recall that the soundness of a tWF net is defined as the soundness of its place-completion which adds a single place before the input transitions and a single place after the output transitions. So if we put a single token in the first place in this place-completion, then only one of the first transitions can fire, after which the net can no longer correctly finish. A similar problem occurs in the pOR net in Figure 3. If it starts with a token in each of its input places, then it cannot finish correctly if it moves the token of the upper input place to the place in the middle of the net. Both types of problems are solved if we only consider one-input one-output versions of tAND and pOR nets, which are all substitution sound nets. Hence we only consider the classes illustrated in Figure 4, which we will refer to as the *basic AND-OR classes*, and the class of nets that is obtained by combining them by substitution we will call the class of *AND-OR nets*.

Definition 14 (AND-OR net). The class $\mathbf{S}(\mathbf{pAND} \cup \mathbf{11tAND} \cup \mathbf{11pOR} \cup \mathbf{tOR})$ is called the class of AND-OR nets.

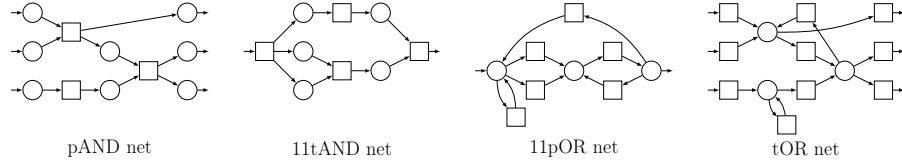

Figure 4: Examples from classes **pAND**, **11tAND**, **11pOR** and **tOR** (from [20])

An example of the generation of an AND-OR net is shown in Figure 5, with on the left the hierarchical decomposition and on the right the resulting net.

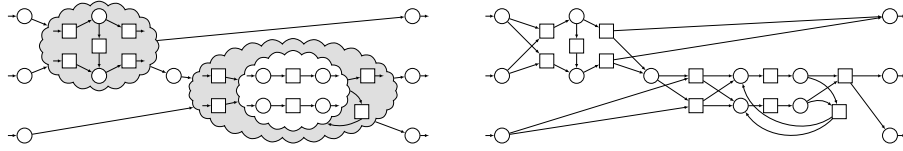

Figure 5: An example of the generation of an AND-OR net (adapted from [20])

4 The AND-OR reduction

We now proceed with presenting the AND-OR net verification procedure. Informally, the procedure can be described as reversing the generation process. This means that we try to find subnets that might have been generated by a substitution and reverse the substitution. This process is repeated until we can find no more such subnets, and if then the resulting net is a single node, the original net is concluded to be an AND-OR net.

Definition 15 (Subnet). A subnet in workflow net $M = (P_M, T_M, F_M, I_M, O_M)$ is identified by a non-empty set of nodes $S \subseteq P_M \cup T_M$. With S we associate a net $M[S] = (P_S, T_S, F_S, I_S, O_S)$ that is the restriction of M to the nodes in S , i.e.,

- $P_S = P_M \cap S$,
- $T_S = T_M \cap S$,
- $F_S = F_M \cap (S \times S)$,
- $I_S = (I_M \cap S) \cup \{n_2 \mid (n_1, n_2) \in F_M, n_1 \in ((P_M \cup T_M) \setminus S), n_2 \in S\}$ and
- $O_S = (O_M \cap S) \cup \{n_1 \mid (n_1, n_2) \in F_M, n_1 \in S, n_2 \in ((P_M \cup T_M) \setminus S)\}$.

A subnet consisting of exactly one node will be called a *trivial subnet*.

Note that the input nodes of $M[S]$ are not just the nodes in S that are input nodes of M but also contains the nodes in S that have in M incoming edges from outside S . Analogously the output nodes are the nodes in S that are output nodes of M or have in M an outgoing edge to a node outside S .

Not every subnet of a WF net is again itself a WF net, but it will always be an I/O net.

Lemma 16 (subnets are I/O nets). *Let S be a non-empty subset of nodes of a WF net M , then $M[S]$ is an I/O net.*

Proof. Let $M = (P_M, T_M, F_M, I_M, O_M)$. For $M[S] = (P_S, T_S, F_S, I_S, O_S)$ to be an I/O net the following must be shown. First the defining properties of a Petri net: (i) $P_S \cap T_S = \emptyset$, (ii) $F_S \subseteq (T_S \times P_S) \cup (P_S \times T_S)$. Furthermore the additional defining properties of an I/O net: (iii) $I_S \neq \emptyset$ and $O_S \neq \emptyset$. We can show these as follows:

- (i) Since $P_M \cap T_M = \emptyset$, and by definition $P_S = P_M \cap N$ and $T_S = T_M \cap N$, it follows that $P_S \cap T_S = \emptyset$.
- (ii) Since $F_M \subseteq (P_M \times T_M) \cup (T_M \times P_M)$, it follows that

$$\begin{aligned}
F_S &= F_M \cap (N \times N) \\
&\subseteq ((P_M \times T_M) \cup (T_M \times P_M)) \cap (N \times N) \\
&= ((P_M \times T_M) \cap (N \times N)) \cup ((T_M \times P_M) \cap (N \times N)) \\
&= ((P_M \cap N) \times (T_M \cap N)) \cup ((T_M \cap N) \times (P_M \cap N)) \\
&= (P_S \times T_S) \cup (T_S \times P_S)
\end{aligned}$$

- (iii) We show that $I_S \neq \emptyset$. In the case where $S \cap I_M \neq \emptyset$, this is trivially satisfied. In the case where $S \cap I_M = \emptyset$ there will be a node in S that has in M an incoming edge from outside S , since in M all nodes must be reachable from an input node of M and S is non-empty. This node will hence be an input node of $M[S]$. In a similar fashion it can be shown that $O_S \neq \emptyset$.

□

In addition, it can also be shown that every subnet is well-connected.

Lemma 17 (well-connectedness of subnets). *Let S be a non-empty subset of nodes of a WF net M , then $M[S]$ is well-connected.*

Proof. We first show that every node in S has in $M[S]$ a path to an output node of $M[S]$. Since M is well-connected, every node in S will have a path to an output node of M . There either (i) is a node in that path that is not in S or (ii) all nodes of the path are in S :

- (i) Consider the longest prefix of the path that contains only nodes in S . The final node will be an output node of $M[S]$, since it is followed by a node not in S . Moreover, this path is present in $M[S]$ since it only contains nodes from S .

- (ii) The final node of the path is an output node of M , and therefore also an output node of $M[S]$.

In a similar fashion it can be shown that to every node in S there is in $M[S]$ a path from an input node of $M[S]$, except that the edges and the paths are reversed and the set of output nodes is replaced with the set of input nodes. \square

Since the definition of a WF net is an I/O net that is well-connected and I/O consistent, it follows immediately from the previous two lemmas, Lemma 16 and Lemma 17, that a subnet of WF net is a WF net iff it is I/O consistent.

Theorem 18. *Let S be a non-empty set of nodes of a WF net M , then $M[S]$ is a WF net iff it is I/O consistent.*

We now proceed with defining the notion of *contraction*, i.e., a contraction of a subnet S of a WF net M into a single new node n such that (1) all edges that departed from outside S and arrived in an input node of S become edges arriving in n , (2) all edges that arrived in a node outside S and left from an output node of S become edges leaving from n . Moreover, if S contained an input node of M then n becomes also an input node, and if S contained an output node of M then n becomes also an output node. Formally, the definition is as follows.

Definition 19 (Contraction). Given a WF net $M = (P_M, T_M, F_M, I_M, O_M)$ and a subnet S such that $M[S] = (P_S, T_S, F_S, I_S, O_S)$ is a pWF net (tWF net), we define the result of contracting S into a new place (transition) node n as $M' = (P_{M'}, T_{M'}, F_{M'}, I_{M'}, O_{M'})$ where

- $P_{M'} = (P_M \setminus S) \cup \{n\}$, ($P_{M'} = P_M \setminus S$),
- $T_{M'} = T_M \setminus S$, ($T_{M'} = (T_M \setminus S) \cup \{n\}$),
- $F_{M'} = \{(n_1, n_2) \mid (n_1, n_2) \in F_M, n_1 \notin S, n_2 \notin S\} \cup \{(n_1, n) \mid (n_1, n_2) \in F_M, n_1 \notin S, n_2 \in I_S\} \cup \{(n, n_2) \mid (n_1, n_2) \in F_M, n_1 \in O_S, n_2 \notin S\}$,
- $I_{M'} = \begin{cases} I_M & \text{if } S \cap I_M = \emptyset \\ (I_M \setminus S) \cup \{n\} & \text{otherwise,} \end{cases}$
- $O_{M'} = \begin{cases} O_M & \text{if } S \cap O_M = \emptyset \\ (O_M \setminus S) \cup \{n\} & \text{otherwise.} \end{cases}$

An important property of the contraction is that it preserves paths, as is witnessed by the following lemma.

Lemma 20 (preservation of paths by contraction). *Let M' be the result of contracting in a WF net M a subnet S into n . Then, for every path in M there is a similar path in M' where all maximal substrings of nodes in S are replaced with n .*

Proof. Clearly all edges between nodes outside S are not affected by the contraction. What remains to consider are the following possibilities: (i) an edge from outside S to inside S , (ii) an edge from inside S to outside S and (iii) an edge from inside S to inside S .

- (i) If there is in M an edge (n_1, n_2) from outside S to inside S , then by the definition of $M[S]$ the node n_2 is an input node of $M[S]$, and so by the definition of contraction there is in M' an edge from n_1 to n .
- (ii) By a similar argument it holds that if there is in M an edge (n_1, n_2) from inside S to outside S , then there is in M' an edge from n to n_2 .
- (iii) For every edge (n_1, n_2) from inside S to inside S there is the corresponding trivial one-node path (n) in M' .

It follows that for each edge in M there is a corresponding path in M' such that if two edges in M have the same begin node or end node, then the corresponding paths also have the same begin node or end node, respectively. Therefore, we can concatenate the corresponding paths in the order of the original edges in the path in M , and obtain a path in M' . \square

With the help of this lemma it can be shown that the result of a contraction of a subnet in a pWF net (tWF net) is always a pWF net (tWF net).

Theorem 21 (correctness of the result of contraction). *If M is a pWF net (tWF net), then the result M' of contracting a subnet S of M into a node n is again a pWF net (tWF net).*

Proof. In order for $M' = (P_{M'}, T_{M'}, F_{M'}, I_{M'}, O_{M'})$ to be a WF net the following must be shown. First, the defining properties of a Petri net: (i) $P_{M'} \cap T_{M'} = \emptyset$, (ii) $F_{M'} \subseteq (T_{M'} \times P_{M'}) \cup (P_{M'} \times T_{M'})$. Furthermore, the defining properties of a WF net: (iii) $I_{M'} \neq \emptyset$ and $O_{M'} \neq \emptyset$, (iv) $I_{M'} \cup O_{M'} \subseteq P_{M'}$ or $I_{M'} \cup O_{M'} \subseteq T_{M'}$, (v) for every node in $P_{M'} \cup T_{M'}$ there is a path to that node from a node in $I_{M'}$, and (vi) for every node in $P_{M'} \cup T_{M'}$ there is a path from that node to a node in $O_{M'}$. Finally, it can be concluded that (vii) the I/O type of M is the same as that of M' .

- (i) It holds for nodes unequal to n , because it holds for M , and except for the new node n it holds that $P_{M'}$ and $T_{M'}$ are subsets of P_M and T_M , respectively. It also holds for the new node n , since it is either added to $P_{M'}$ or $T_{M'}$.
- (ii) Since this holds for M , and nodes outside S and edges between them are not removed, it follows that edges from M that are also present in M' are between nodes in $P_{M'}$ and $T_{M'}$. For an edge in M' between n and another node n' we can argue as follows. There must have been an edge in M between a node n'' in S and n' . In that case n'' must have been an input or output node of $M[S]$, and therefore of the same type as n , from which it follows that n' is of a different type as n .

- (iii) We first consider $I_{M'}$. In the case where $S \cap I_M = \emptyset$, the property holds since it holds for M . In the case where $S \cap I_M \neq \emptyset$ there will at least be n in $I_{M'}$.

The proof for $O_{M'}$ proceeds similarly.

- (iv) We can show that if M is pWF net, then it holds that $I_{M'}, O_{M'} \subseteq P_{M'}$, and if M is a tWF net then it holds that $I_{M'}, O_{M'} \subseteq T_{M'}$. We consider the two cases:

M is a pWF net: We first derive that $I_{M'} \subseteq P_{M'}$ and for this we consider the cases (a) $M[S]$ is a pWF net and (b) $M[S]$ is a tWF net:

- (a) If $M[S]$ is a pWF net, the argument goes as follows.
- If $S \cap I_M = \emptyset$ then clearly $I_{M'} = I_M \subseteq (P_M \setminus S) \cup \{n\} = P_{M'}$ since from $I_M \subseteq P_M$ and $S \cap I_M = \emptyset$ it follows $I_M \subseteq P_M \setminus S$.
 - If, on the other hand, $S \cap I_M \neq \emptyset$ then clearly $I_{M'} = (I_M \setminus S) \cup \{n\} \subseteq (P_M \setminus S) \cup \{n\} = P_{M'}$ since $I_M \subseteq P_M$.
- (b) If $M[S]$ is a tWF net, the argument goes as follows.
- If $S \cap I_M = \emptyset$ then clearly $I_{M'} = I_M \subseteq P_M \setminus S = P_{M'}$ since from $I_M \subseteq P_M$ and $S \cap I_M = \emptyset$ it follows $I_M \subseteq P_M \setminus S$.
 - If, on the other hand, $S \cap I_M \neq \emptyset$, then we get a contradiction since a node $n' \in S \cap I_M$ would be by definition in I_S and therefore a transition, since $M[S]$ is a tWF net, as well as a place in M , since M is a pWF net.

By a similar argument, where I_M and $I_{M'}$ are replaced with O_M and $O_{M'}$, respectively, it can be shown that $O_{M'} \subseteq P_{M'}$.

M is a tWF net: Proceeds similar as in the previous case, except that the cases (a) and (b) are swapped, i.e., the argument of (a) is used for the case where $M[S]$ is a tWF net, and the argument (b) is used where $M[S]$ is a pWF net.

- (v) A node in M' is either a (a) a node in M or (b) node n . In case (a) there would have been in M a path from an input node of M to that node. By Lemma 20 a similar path exists in M' . Moreover, the start node of the similar path will also be an input node of M' , since it either is a node in M , in which case it will still be an input node of M' , or it is replaced with n , in which case n will be an input node of M' . In case (b) there would have been in M a path from an input node of M to an input node of $M[S]$. By Lemma 20 a similar path exists in M' which ends in n . Also in this case it holds that the begin node of this path is an input node of M' .
- (vi) Is similar to case (v), but with the directions of paths and edges reversed, and the roles of set of input nodes and output nodes interchanged.
- (vii) This case follows immediately by the reasoning in (iv).

□

During the AND-OR reduction we will search for non-empty subset of nodes S in a workflow net M such that their associated net $M[S]$ is in a basic AND-OR class and contract them into a single new node. Such a contraction should be the inverse of a substitution of this new node with $M[S]$ in the sense that if we apply the contraction and then the substitution we should again have the same WF net. However, applying that substitution may not give back M if, for example, not all input nodes of $M[S]$ have in M the same incoming edges from outside S , since that is a property that always holds after a substitution. Therefore we define the notion of *well-nestedness* for subnets that captures the properties of input and output nodes that guarantee applying the substitution after contraction always gives back M .

Definition 22 (Well-nested subnet). A subnet S is said to be well-nested in M if it holds that:

1. for any two input nodes n_1, n_2 in $M[S]$, i.e., any two nodes $n_1, n_2 \in I_S$, it holds that
 - (a) for every $n_3 \notin N$ it holds that $(n_3, n_1) \in F_M$ if $(n_3, n_2) \in F_M$
 - (b) $n_1 \in I_M$ if $n_2 \in I_M$
2. for any two output nodes n_1, n_2 in $M[S]$, i.e., any two nodes $n_1, n_2 \in O_S$, it holds that
 - (a) for every $n_3 \notin N$ it holds that $(n_1, n_3) \in F_M$ if $(n_2, n_3) \in F_M$
 - (b) $n_1 \in O_M$ if $n_2 \in O_M$

A subnet that is well-nested, and where the associated net $M[S]$ is WF net (pWF, tWF) net will be called a *well-nested WF (pWF, tWF) net*.

It is then not hard to see that contractions of well-nested subnets are the inverse of substitutions. To be more precise it holds that if a contraction is followed by a substitution that replaces the new node with the WF net associated with the contracted well-nested subnet, then the result is the original WF net. Vice versa, it holds that if a substitution is followed by a contraction of the substituted well-nested net, we again obtain the original WF net, up to the choice of the identity of the new node.

Definition 23 (AND-OR contractible). We will call a well-nested WF net in M *AND-OR contractible* if (1) it is a well-nested WF net and (2) is of a basic AND-OR class.

Recall from Section 3 that the basic AND-OR classes are pAND, 11tAND, 11pOR and tOR. Based on this we define the AND-OR contraction relation which will form the basis of the reduction process.

Definition 24 (AND-OR contraction relation). The *AND-OR contraction relation* is the binary relation \rightsquigarrow over WF nets such that $M \rightsquigarrow M'$ expresses that there is an AND-OR contractible WF net N in M and that the contraction of N in M can result in M' . The reflexive and transitive closure of \rightsquigarrow is denoted as \rightsquigarrow^* .

An interesting property of the contraction relation is that it has the *local confluence* property, as stated by the following theorem.

Theorem 25 (local confluence of the AND-OR contraction relation). *For all WF nets M , M_1 and M_2 it holds that if $M \rightsquigarrow M_1$ and $M \rightsquigarrow M_2$, then there is a WF net M_3 such that $M_1 \rightsquigarrow^* M_3$ and $M_2 \rightsquigarrow^* M_3$.*

Proof of this theorem will be given in Section 5.

However, if we consider \rightsquigarrow as the basis of a rewriting procedure where we contract contractible subnets until no more such nets can be found, we have the problem that this procedure will never terminate. This is because every node in a WF net is by itself a contractible subnet. Of course, in that case the contraction does not actually change the WF net, except that it replaces the node with a new node. This could be solved by restricting ourselves to contractions of non-trivial subnets. However, in that case we lose the property of local (and global) confluence, since the rewriting procedure could pick different node identifiers when it contracts a certain subnet and thereby end up with different nets. However, except for the choice of the node identifiers, these nets would be the same, and in that sense the procedure would in fact be confluent. To show this formally we define another contraction relation that holds between equivalence classes of WF nets containing isomorphic WF nets. Here we define WF nets as isomorphic if they are identical up to the identity of the nodes.

Definition 26 (net isomorphism). Given WF nets $M = (P_M, T_M, F_M, I_M, O_M)$ and $M' = (P_{M'}, T_{M'}, F_{M'}, I_{M'}, O_{M'})$, we say that a function $h : (P_M \cup T_M) \rightarrow (P_{M'} \cup T_{M'})$ is an *isomorphism* from M to M' , denoted as $M \sim_h M'$, if it holds that

- $P_{M'} = \{h(n) \mid n \in P_M\}$, $T_{M'} = \{h(n) \mid n \in T_M\}$,
- $F_{M'} = \{(h(n_1), h(n_2)) \mid (n_1, n_2) \in F_M\}$,
- $I_{M'} = \{h(n) \mid n \in I_M\}$ and $O_{M'} = \{h(n) \mid n \in O_M\}$.

We say that M_1 and M_2 are *isomorphic*, written as $M_1 \sim M_2$, if for some h it holds that $M_1 \sim_h M_2$.

It is easy to verify that the isomorphism relation is an equivalence relation, and so can be used to define equivalence classes. We will let $[M]$ denote the class of WF nets isomorphic to a WF net M . The AND-OR contraction relation can be adapted to the equivalence classes of an isomorphism.

Definition 27 (class-based AND-OR contraction relation). The *class-based AND-OR contraction relation* is the binary relation \rightsquigarrow over WF nets such that $[M] \rightsquigarrow [M']$ expresses that (1) $[M] \neq [M']$ and (2) there are WF nets $M_1 \in [M]$ and $M_2 \in [M']$, such that $M_1 \rightsquigarrow M_2$. The reflexive and transitive closure of \rightsquigarrow is denoted as \rightsquigarrow^* .

Note that the class-based contraction relation is irreflexive, and therefore does not consider contractions of one-node WF nets, which always result in an isomorphic net. So only contractions of subnets with two or more nodes are considered, which necessarily produces a WF net that is not isomorphic, since it strictly reduces the number of nodes. It follows that \rightsquigarrow is *well-founded*.

Proposition 28 (well-foundedness of class-based contraction). *The relation \rightsquigarrow has no infinite sequences $[M_1] \rightsquigarrow [M_2] \rightsquigarrow [M_3] \rightsquigarrow \dots$*

Based on the class-based contraction relation we can then define the notion of AND-OR reduction. The well-foundedness of class-based contraction ensures that a procedure that tries to determine a class-based AND-OR reduction by contracting contractible non-trivial subnets of basic AND-OR types, will always terminate.

Definition 29 (class-based AND-OR reduction). A *class-based AND-OR reduction* of a WF net M is a WF net M' such that (1) $[M] \rightsquigarrow^* [M']$ and (2) there is no WF net M'' such that $[M'] \rightsquigarrow [M'']$.

Another observation that can be made is that the definition of contraction is generic with respect to node identity, i.e., it compares nodes to each other but never to a specific value. It follows that the contraction relation commutes with the isomorphism relation.

Lemma 30 (genericity of contraction). *If $M_1 \rightsquigarrow M_2$ and $M_1 \sim M'_1$, then there is a WF net M'_2 such that $M_2 \sim M'_2$ and $M'_1 \rightsquigarrow M'_2$.*

Proof. Let us assume that $M_1 \rightsquigarrow M_2$ and $M_1 \sim_h M'_1$. Then it is not hard to see that if a subnet S is contractible in M_1 , the subset $M'_1[S']$ where $S' = \{h(n) \mid n \in S\}$ is contractible in M'_1 . Moreover, the contraction of this subnet will be isomorphic to the result of the contraction of S , where the homomorphism is identical to h , except that it maps the node that $M_1[S]$ was contracted into, to the node that $M'_1[S']$ is contracted into. \square

A consequence of this is that the local confluence property is inherited from the normal contraction relation.

Theorem 31 (local confluence of the class-based AND-OR contraction relation). *For all WF nets M , M_1 and M_2 it holds that if $[M] \rightsquigarrow [M_1]$ and $[M] \rightsquigarrow [M_2]$, then there is a WF net M_3 such that $[M_1] \rightsquigarrow^* [M_3]$ and $[M_2] \rightsquigarrow^* [M_3]$.*

Proof. Let us assume that $[M] \rightsquigarrow [M_1]$ and $[M] \rightsquigarrow [M_2]$. Then by the definition of class-based contraction there are WF nets M' and M'_1 such that $M' \sim M$, $M'_1 \sim M_1$ and $M' \rightsquigarrow M'_1$, and that there are WF nets M'' and M''_2 such that $M'' \sim M$, $M''_2 \sim M_2$ and $M'' \rightsquigarrow M''_2$. Since $M' \sim M$ and $M'' \sim M$, it follows that $M' \sim M''$. It then follows by Lemma 30, from $M' \sim M''$ and $M'' \rightsquigarrow M''_2$, that there is a WF net M'_2 such that $M'_2 \sim M''_2$ and $M' \rightsquigarrow M'_2$. It then follows by Theorem 25, from $M' \rightsquigarrow M'_1$ and $M' \rightsquigarrow M'_2$, that there is a WF net M_3 such that $M'_1 \rightsquigarrow^* M_3$ and $M'_2 \rightsquigarrow^* M_3$. By induction on the number of contractions,

it follows from the definition of class-based contractions, that $[M'_1] \rightsquigarrow^* [M_3]$ and $[M'_2] \rightsquigarrow^* [M_3]$. Since $M_1 \sim M'_1$ and $M_2 \sim M'_2$, it holds that $[M'_1] = [M_1]$ and $[M'_2] = [M_2]$, and so $[M_1] \rightsquigarrow^* [M_3]$ and $[M_2] \rightsquigarrow^* [M_3]$. \square

Since the class-based contraction relation is well-founded, as stated by Property 28, it follows by *Newman's Lemma* (sometimes also called the *diamond Lemma*, see [10]) that the procedure is globally confluent.

Theorem 32 (global confluence of the class-based AND-OR contraction relation). *For all WF nets M , M_1 and M_2 it holds that if $[M] \rightsquigarrow^* [M_1]$ and $[M] \rightsquigarrow^* [M_2]$, then there is a WF net M_3 such that $[M_1] \rightsquigarrow^* [M_3]$ and $[M_2] \rightsquigarrow^* [M_3]$.*

An immediate consequence of this is that the result of the class-based AND-OR reduction is unique.

Theorem 33 (unique result of class-based AND-OR reduction). *Let $[M_1]$ and $[M_2]$ be two results of the class-based AND-OR reduction of a WF net M , then $[M_1] = [M_2]$.*

Proof. From global confluence, Theorem 32, it follows that there is a WF net M_3 such that $[M_1] \rightsquigarrow^* [M_3]$ and $[M_2] \rightsquigarrow^* [M_3]$. However, by the definition of the class-based AND-OR reduction, it also holds that there is no WF net M_4 such that $[M_1] \rightsquigarrow [M_4]$, and also no WF net M_4 such that $[M_2] \rightsquigarrow [M_4]$. It then follows that $[M_1] = [M_2]$. \square

In an actual implementation of the reduction, the classes would be represented by actual WF nets. Therefore we define an alternative notion of AND-OR reduction that operates on WF nets.

Definition 34 (net-based AND-OR reduction). A *net-based AND-OR reduction* of a WF net M is a WF net M' such that (1) M can be reduced to M' via contractions that contract non-trivial subnets and (2) there is no contractible non-trivial subnet in M' .

We can demonstrate a close relationship between the two types of AND-OR reductions.

Theorem 35 (similarity of AND-OR reductions). *Let M and M' be two WF nets, then $[M']$ is the result of applying the class-based AND-OR reduction to M iff there is a WF net M'' such that M'' is the result of applying the net-based AND-OR reduction to M and $M'' \sim M'$.*

Proof. We first consider the *if*-part. It is clear that if there is a series of contractions that leads from M to M'' , then $[M] \rightsquigarrow^* [M'']$. Since there are no contractible subnets in M'' of two nodes or more, it follows that only contractions of one-node subnets are possible, which leave the net isomorphic. And so, there is no WF net M_2 such that $[M''] \rightsquigarrow [M_2]$, since the class-based AND-OR contraction is by definition irreflexive.

We now consider the *only-if* part. Assume that $[M] \rightsquigarrow^* [M']$. This means that $[M_0] \rightsquigarrow [M_1] \rightsquigarrow \dots \rightsquigarrow [M_n]$ for some sequence of nets M_0, M_1, \dots, M_n

where $M_0 \sim M$ and $M_n \sim M'$. Then by using Lemma 30 on the genericity of contraction, for each step in this sequence of class-based contractions it follows that there is a series of net-based contractions that reduces some net M'_0 which is isomorphic to M to a WF net M'_n which is isomorphic to M' . Moreover, each contraction between two classes will contract two nodes or more, and so the same will hold for this series of net contractions. It remains to observe that as there are no more non-trivial net contractions possible in M'_n which follows from the fact that the class-based reduction stopped at $[M']$ and $M'_n \sim M'$. This completes the proof with M'_n being the postulated M'' . \square

A direct consequence of Theorem 35 on the similarity of net-based and class-based AND-OR reduction, and Theorem 33 on the uniqueness of the result of the class-based AND-OR reduction, is that the result of the net-based AND-OR reduction is unique up to isomorphism.

Theorem 36 (unique result of net-based AND-OR reduction). *Let M_1 and M_2 be two results of the net-based AND-OR reduction of a WF net M , then $M_1 \sim M_2$.*

Proof. Assume that M_1 and M_2 are both results of the net-based AND-OR reduction of a WF net M . By Theorem 35 it follows that $[M_1]$ and $[M_2]$ are both results of the class-based AND-OR reduction of M . From the uniqueness of the result of the class-based reduction, as stated by Theorem 33, it follows that $[M_1] = [M_2]$, which implies $M_1 \sim M_2$. \square

5 Local confluence of the AND-OR contraction relation

In this section we show the local confluence of the AND-OR contraction relation, as stated by Theorem 25. To simplify the presentation of the proof, we will at first restrict ourselves to contractions that do not involve input and output nodes of the larger net, i.e., where $S \cap I_M = S \cap O_M = \emptyset$. It is easy to see that for such contractions $I_{M'} = I_M$ and $O_{M'} = O_M$ if M' is the result of the contraction, which simplifies the definition of the result of the contraction. We will call such contractions *internal contractions*, and a well-nested WF net that does not share input nor output nodes with the larger WF net will be called an *internal well-nested WF net*. We will call an internal well-nested net that is of one of the basic AND-OR classes *internal AND-OR contractible*. We let $\rightsquigarrow_{\text{int}}$ denote the restriction of \rightsquigarrow where only internal contractions are used.

The restriction to internal contractions is interesting because the general reduction process can be simulated by (1) taking the place or transition completion of the input net, (2) applying only internal contractions and (3) removing the input an output place while making the nodes in the postset of the input node the new input places and the nodes in the preset of the output place the new output nodes. Each contraction in the reduction process on the original WF net will then correspond to an internal contraction on the completed WF

net, and vice versa. It follows that the result is then the place completion of a single transition or a transition completion of a single place iff the result of the reduction process on the original input WF net is a single place or a single transaction.

Since in the remainder of this section we will talk mostly about internal AND-OR contractions, we will refer to internal contractions, internal well-nested subnets, and internal contractible nets simply as *contractions*, *well-nested subnets* and *contractible nets*, respectively, unless stated otherwise.

To show local confluence, we will set out to prove that if there are two subnets that are both contractible, then (1) the contraction of one does not change the contractibility of the other one (although its structure might change somewhat because of the contraction) and (2) the result of contracting the two nets in either order results in the same WF net. This is straightforward to see if the subnets are completely independent, i.e., they do not overlap and there are no edges that connect a node in one subnet to a node in the other subnet. In this case the contraction of one subnet does not change the other subnet or the edges connected to it, and so does not change the contractibility. If the two subnets are not completely independent we can distinguish four cases, which are illustrated in Figure 6. In this figure we use clouds to indicate subnets and rounded rectangles to represent nodes that can be either places or transitions.

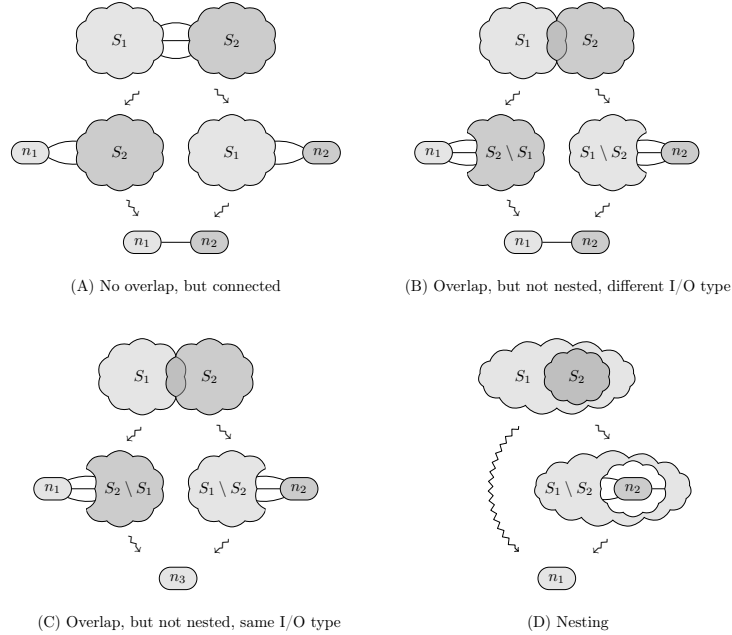

Figure 6: The four cases considered in the confluence proof

(A) *The subnets S_1 and S_2 do not share nodes, but nodes in S_1 are connected*

to nodes in S_2 : In this case the contraction of one subnet will not change the other subnet, but it might change the edges connected to it. However, as will be shown, this subnet will remain well-nested and therefore contractible. Note that there might be multiple edges between S_1 and S_2 , but after contracting subnets defined by them into n_1 and n_2 , there will be at most one edge from n_1 to n_2 , and vice versa.

- (B) *The subnets S_1 and S_2 overlap, but are not nested in one another and the I/O type of the two nets is different:* In this case the contraction of one subnet, say $M[S_1]$, removes a part of S_2 . It must therefore be shown that after the contraction the remainder of $M[S_2]$, i.e., the subnet $S_2 \setminus S_1$ is a contractible net, i.e., it is well-nested and belongs to a basic AND-OR class, or is already a one-node WF net, in which case no further contraction is required. In fact, it will be shown that it will belong to the same basic AND-OR class as $M[S_2]$. Note that since $M[S_1]$ and $M[S_2]$ have different I/O types, it follows that n_1 and n_2 have different types, which is required in a Petri net for connected nodes.

It must also be shown that the final result with nodes n_1 and n_2 is the same, independent of whether first S_1 or first S_2 is contracted. This means that (a) the edges between n_1 and n_2 must be the same, (b) the edges between n_1 and nodes other than n_2 must be the same and (c) the edges between n_2 and nodes other than n_1 must be the same.

- (C) *The subnets S_1 and S_2 overlap, are not nested in one another and the I/O type of the two nets is the same:* In this case we contract in the second step not just the subnet consisting of the remainder of the subnet that was not contracted, say $M'[S_2 \setminus S_1]$, but the total of that remainder plus the new node, which would be the subnet $(S_2 \setminus S_1) \cup \{n_1\}$. Therefore it must be shown that this subnet is a contractible net. In fact, it will be shown that it will belong to the same basic AND-OR class as $M[S_2]$. Note that since $M[S_1]$ and $M[S_2]$ have the same I/O type, we cannot simply contract $S_2 \setminus S_1$ in M' , since that would result in a node of the same type as n_1 .

It must also be shown that the final result with node n_3 is the same, independent of whether first S_1 or first S_2 is contracted. This means that n_3 must be participating in the same edges.

- (D) *The subnet S_1 contains the subnet S_2 :* The first option is to contract S_1 into n_1 , in which case S_2 completely disappears. The second option is to contract S_2 into n_2 . It will be shown that after this step the subnet defined by the remainder of S_1 plus the new node n_2 , i.e., $(S_2 \setminus S_1) \cup \{n_2\}$, is contractible in M' . In fact, it will be shown that it will belong to the same basic AND-OR class as $M[S_1]$ in the original workflow net.

It must also be shown that the final result with node n_1 is the same, independent of whether first S_1 or first S_2 is contracted. This means that n_1 must be participating in the same edges.

In the following subsections we will discuss the necessary proofs for each of the mentioned cases in detail.

5.1 Connected non-overlapping subnets

In this subsection we consider case (A) in Figure 6. Therefore, let us assume that S_1 and S_2 are contractible subnets in a WF net M , and do not share nodes, but are connected by edges. Let us also assume that M' is the result of contracting S_1 into the node n_1 and M'' the result of contracting S_2 into the node n_2 . Recall that we need to show that (1) the contraction of S_1 does not affect the contractibility of S_2 and (2) we get the same result by contracting S_1 and then S_2 as with contracting S_2 and then S_1 . This is captured by the following two lemmas.

Lemma 37 (preservation of contractibility). *The subnet S_2 is contractible in M' .*

Proof. Recall that a subnet S is contractible in M if the following two properties hold: (C1) N is well-nested and (C2) $M[S]$ is of a basic AND-OR type. Since the contraction of S_1 does not change the nodes of S_2 or edges between them, it is clear that $M'[S_2]$ has the same places, transitions and edges as $M[S_2]$. Also the set of input nodes is the same, because if in M a node in S_2 had an incoming edge from outside S_2 , it will still have such an edge after the contraction, and for internal subnets this defines whether a node is an input. By a similar argument it holds that the set of output nodes remains the same. Since all the components do not change, it follows that (C2) is preserved for $M'[S_2]$. So it remains to be shown that property (C1) is preserved.

Since we consider only internal subnets, it is sufficient to show that (1) for all two edges (n_2, n_3) and (n_4, n_5) in M' such that $n_2, n_4 \notin S_2$ and $n_3, n_5 \in S_2$, there are also the edges (n_2, n_5) and (n_4, n_3) in M' , and (2) for all two edges (n_2, n_3) and (n_4, n_5) in M' such that $n_3, n_5 \notin S_2$ and $n_2, n_4 \in S_2$, there are also the edges (n_2, n_5) and (n_4, n_3) in M' .

To show (1) we start with assuming that there are two edges (n_2, n_3) and (n_4, n_5) in M' such that $n_2, n_4 \notin S_2$ and $n_3, n_5 \in S_2$. Then, we consider the three possible cases were (i) both n_2 and n_4 are equal to n_1 , (ii) only one of n_2 and n_4 is equal to n_1 and (iii) both n_2 and n_4 are unequal to n_1 .

(i) It then follows that $(n_2, n_3) = (n_1, n_3) = (n_4, n_3)$ and $(n_4, n_5) = (n_1, n_5) = (n_2, n_5)$, and so the edges (n_4, n_3) and (n_2, n_5) indeed also exist in M' .

(ii) We can assume without loss of generality that $n_2 = n_1$ and $n_4 \neq n_1$. The reasoning is then as illustrated in Figure 7 (a). By definition of contraction there is in M an edge (n_4, n_5) and an edge (n'_2, n_3) with n'_2 an output node of $M[S_1]$. Since S_2 is by assumption well-nested in M , there are therefore also the edges (n'_2, n_5) and (n_4, n_3) in M . By the definition of contraction it then follows that there are edges (n_1, n_5) and (n_4, n_3) in M' .

- (iii) The reasoning is then as illustrated in Figure 7 (b). By definition of contraction there are edges (n_2, n_3) and (n_4, n_5) in M . Since S_2 is by assumption well-nested in M , there are therefore also the edges (n_2, n_5) and (n_4, n_3) in M . By the definition of contraction it then follows that there are edges (n_1, n_5) and (n_4, n_3) in M' .

The proof for (2) is similar, but with the direction of the edges reversed and the roles of input and output nodes interchanged. \square

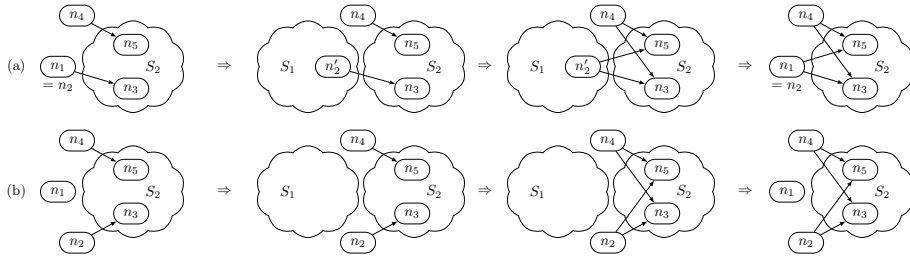

Figure 7: Illustration of proof of preservation of well-nestedness in case (A)

Lemma 38 (commutativity of contraction). *Let M_1'' be the result of first contracting S_1 into node n_1 resulting in M_1' followed by contracting S_2 into node n_2 , and let M_2'' be the result of first contracting S_2 into node n_2 resulting in M_2' followed by contracting S_1 into node n_1 . Then $M_1'' = M_2''$.*

Proof. Clearly M_1'' and M_2'' will have the same set of nodes, namely $(N \setminus (S_1 \cup S_2)) \cup \{n_1, n_2\}$. The types of the nodes in M will not change, and the types of n_1 and n_2 are also identical in M_1'' and M_2'' since they are determined by the I/O type of $M[S_1]$ and $M[S_2]$ respectively, and this is not changed for $M[S_1]$ by the contraction of $M[S_2]$ and vice versa.

That the edges are also the same in M_1'' and M_2'' can be shown as follows. For edges in these nets between nodes in M it is clear that they are the same since contractions preserve these. We therefore consider the remaining three types of edges in these nets: (i) edges between n_1 and n_2 , (ii) edges between n_1 and nodes in M and (iii) edges between n_2 and nodes in M .

- (i) For both M_1'' and M_2'' it holds that they contain an edge (n_1, n_2) iff there is an edge in M between an output node of $M[S_1]$ and an input node of $M[S_2]$ in M . So it holds that M_1'' contains the edge (n_1, n_2) iff M_2'' contains it. By symmetry the same holds for the edge (n_2, n_1) .
- (ii) let n_3 be a node in M . For both M_1'' and M_2'' it holds that they contain the edge (n_1, n_3) iff there is an edge in M between an output node of $M[S_1]$ and n_3 . So it holds that M_1'' contains the edge (n_1, n_3) iff M_2'' contains it. By a symmetrical argument the same holds for the edge (n_3, n_1) .

- (iii) The argument is similar to that of the previous case, but with S_1 and n_1 replaced with S_2 and n_2 , respectively.

□

5.2 Overlapping, but not nested, subnets with different I/O types

In this subsection we consider case (B) in Figure 6. Therefore, we assume that S_1 and S_2 are contractible subnets in M such that (i) they share nodes but not so that one is entirely nested inside the other and (ii) the WF nets $M[S_1]$ and $M[S_2]$ different I/O types. Let us also assume that M' is the result of contracting S_1 into the node n_1 and M'' the result of contracting S_2 into the node n_2 . Recall that we need to show that (1) after contraction of S_1 into n_1 , the subnet $S_2 \setminus S_1$ is contractible and (2) if we contract first S_1 into n_1 and then $S_2 \setminus S_1$ into n_2 , the result is the same as when we contract first S_2 into n_2 and then $S_1 \setminus S_2$ into n_1 .

The proof of (1) will be separated into smaller lemmas. Recall that a subnet S is contractible in M if the following two properties hold: (C1) S is well-nested in M and (C2) $M[S]$ is of a basic AND-OR type. There will be a lemma that shows (C1) for $M'[S_2 \setminus S_1]$. The property (C2) will be shown by a set of lemmas that show that the defining properties of basic AND-OR nets are inherited by $M'[S_2 \setminus S_1]$ if they hold for $M[S_2]$. These properties are:

- (i) I/O consistency,
- (ii) the I/O type,
- (iii) AND property,
- (iv) OR property,
- (v) acyclicity and
- (vi) one-input one-output property.

Observe that (i) implies that $M'[S_2 \setminus S_1]$ is a WF net, as follows from Theorem 18, which implies that every I/O consistent subnet of a WF net is a WF net, and the fact M' is indeed a WF, as follows from Theorem 21, which states that the result of a contraction in a WF net is again a WF net. The inheritance of the properties (ii) through (vi) by $M'[S_2 \setminus S_1]$ from $M[S_2]$ shows that the WF net $M'[S_2 \setminus S_1]$ is of the same basic AND-OR type as $M[S_2]$. We now present the lemmas that state that well-nestedness and each of the defining properties of AND-OR nets are preserved. Note that for properties (i) and (ii) we have only one lemma which states that the the type of the input nodes and of the output nodes is preserved, and therefore implies that both (i) and (ii) are preserved. For properties (iii) and (iv) we also have one lemma that proves the preservation of each of the properties.

Lemma 39 (preservation of well-nestedness). *The subnet $S_2 \setminus S_1$ is well-nested in M' .*

Proof. We first show the well-nestedness for input nodes of $M'[S_2 \setminus S_1]$. Since S_2 is an internal subnet, a node in $S_2 \setminus S_1$ is an input node of $M'[S_2 \setminus S_1]$ iff there is in M' an edge that ends in that node and starts from a node not in $S_2 \setminus S_1$. So we need to show that if there are two edges (n_2, n_3) and (n_4, n_5) in M' such that $n_2, n_4 \notin S_2 \setminus S_1$ and $n_3, n_5 \in S_2 \setminus S_1$, then there are edges (n_2, n_5) and (n_4, n_3) in M' . Let us assume that such (n_2, n_3) and (n_4, n_5) exist. We consider the following four cases: (i) both n_2 and n_4 are equal to n_1 , (ii) only one of n_2 and n_4 is equal to n_1 , (iii) neither n_2 nor n_4 are equal to n_1 .

(i) Since $n_2 = n_1 = n_4$, it holds that $(n_4, n_5) = (n_1, n_5) = (n_2, n_5)$ and that $(n_2, n_3) = (n_1, n_3) = (n_4, n_3)$. So it indeed follows that (n_2, n_5) and (n_4, n_3) exist in M' .

(ii) We can assume, without loss of generality, that $n_2 = n_1$ and $n_4 \neq n_1$. The reasoning that follows is illustrated in Figure 8 (a). Then, by definition of contraction, there must be an output node n_6 of $M[S_1]$ and an edge (n_6, n_3) in M . We now distinguish two sub-cases, namely that (1) all output nodes of $M[S_1]$ are in $S_1 \cap S_2$ and (2) there is at least one output nodes of $M[S_1]$ in $S_1 \setminus S_2$. We consider the two cases.

(1) If all output nodes of $M[S_1]$ are in $S_1 \cap S_2$, then so must n_6 . Moreover, it also then holds for all nodes in $S_1 \setminus S_2$ that there is a path in $M[S_1]$ from them to a node in $S_1 \cap S_2$. Take one such path, and take the first edge (n_7, n_8) in that path where $n_7 \in S_1 \setminus S_2$ and $n_8 \in S_1 \cap S_2$. Note that such an edge must exist if the path goes from $S_1 \setminus S_2$ to $S_1 \cap S_2$ and contains only nodes from S_1 . Then, by the well-nestedness of S_2 in M , there is an edge (n_4, n_8) in M , since n_8 and n_5 are both input nodes of $M[N_2]$. Then, it follows that n_8 is an input node of both $M[S_1]$ and $M[S_2]$, because of the incoming edge (n_4, n_8) . This leads to a contradiction, since it is assumed that the I/O types of $M[S_1]$ and $M[S_2]$ are different, and so they cannot share input nodes.

(2) We can assume that n_6 that is the output node of $M[S_1]$ in $S_1 \setminus S_2$. Because of the well-nestedness of $M[S_1]$ there is an edge (n_6, n_3) in M . It then follows from the well-nestedness of $M[S_2]$ that there are also edges (n_6, n_5) and (n_4, n_3) in M . By the definition of contraction it then follows that there are edges (n_1, n_5) and (n_4, n_3) in M' . Since $n_2 = n_1$, there is then also an edge (n_2, n_5) in M' .

(iii) So we assume that $n_2 \neq n_1$ and $n_4 \neq n_1$. The reasoning that follows is illustrated in Figure 8 (b). It follows there are edges (n_2, n_3) and (n_4, n_5) in M . Since S_2 is well-nested, there are edges (n_2, n_5) and (n_4, n_3) in M . Since $n_2, n_3, n_4, n_5 \notin S_1$, such edges are also in M' .

The proof for well-nestedness of the output nodes of $M'[S_2 \setminus S_1]$ is similar to that of the input nodes, except that the direction of the edges is reversed and the set of input nodes is replaced with the set of output nodes. \square

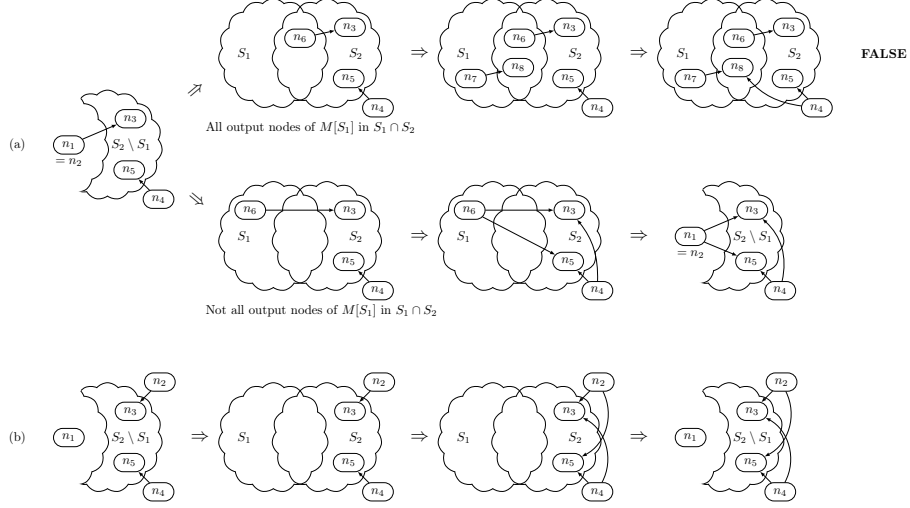

Figure 8: Illustration of proof of preservation of well-nestedness in case (B)

Lemma 40 (preservation of I/O type). *The input nodes and output nodes of $M'[S_2 \setminus S_1]$ have the same type as the input nodes and output nodes of $M[S_2]$, respectively.*

Proof. We first consider input nodes. Assume n_2 is an input node of $M'[S_2 \setminus S_1]$, then it will have in M' an incoming edge (n_3, n_2) with $n_3 \notin S_2 \setminus S_1$. Then either (i) $n_3 = n_1$ or (ii) $n_3 \neq n_1$:

- (i) Then in $M[S_1]$ there is an output node n_4 and an edge (n_4, n_2) . So the type of n_2 in M is the opposite of the I/O type of $M[S_1]$. Since by assumption the I/O type of $M[S_1]$ is the opposite of the I/O type of $M[S_2]$, it follows that the type of n_2 in M is the I/O type of $M[S_2]$, and since the type of a node is not changed by contraction, the type of n_2 in M' is also the I/O type of $M[S_2]$.
- (ii) It follows that this edge exists in M and therefore n_2 is an input node of $M[S_2]$. Since the contraction does not change the type of nodes, the type of n_2 in M' is the same as the type of the input nodes of $M[S_2]$.

The argument for output nodes is similar, except that edges are reversed and the set of input nodes is replaced with the set of output nodes. \square

Lemma 41 (preservation of the AND and the OR property). *The net $M'[S_2 \setminus S_1]$ has the AND (OR) property if $M[S_2]$ has it.*

Proof. We first consider the AND property, and of this first the restriction on incoming edges. The proof proceeds by contradiction, so we start with assuming that $M[S_2]$ has the AND property and $M'[S_2 \setminus S_1]$ does not have the AND

property. We will show that it then follows that $M[S_2]$ does *not* have the AND property.

If $M'[S_2 \setminus S_1]$ does not have the AND property, then in $M'[S_2 \setminus S_1]$ there is a place p such that (i) p has at least two incoming edges and is not an input place or (ii) p is an input place and has an incoming edge (t, p) . In case (i) these two edges already existed in M , and so $M[S_2]$ does not have the AND property. In case (ii) as an input place of an internally nested net p has in M' an incoming edge (t', p) with $t' \notin S_2 \setminus S_1$. It then holds that either (a) $t' \neq n_1$ or (b) $t' = n_1$. We consider these two cases:

- (a) Then (t', p) exists in M and $t' \notin S_1 \cup S_2$. Since there was also an edge (t, p) in $M'[S_2 \setminus S_1]$ with $t \in S_2 \setminus S_1$, which therefore also exists in $M[S_2]$, it follows that p has in $M[S_2]$ at least two distinct incoming edges, and so $M[S_2]$ does not satisfy the AND property.
- (b) Then there is in M an edge (t'', p) from an output transition t'' of $M[S_1]$ to p . It holds that (1) $t'' \in S_1 \cap S_2$ or (2) $t'' \in S_1 \setminus S_2$. If (1) then (t'', p) exists in $M[S_2]$. However, since there is the edge (t, p) in $M'[S_2 \setminus S_1]$ with $t \in S_2 \setminus S_1$, which necessarily also exists in $M[S_2]$, it follows that in $M[S_2]$ the place p has two distinct incoming edges, and therefore does not have the AND property. If (2) then p is an input node in $M[S_2]$, since it has an incoming edge in M starting from a node outside S_2 . However, as we just saw in case (1), there is also an edge (t, p) in $M[S_2]$. So, in $M[S_2]$ the place p is an input node with an incoming edge, and therefore $M[S_2]$ does not have the AND property.

The proof for the restriction on the outgoing edges is similar, except that the direction of the edges is reversed and the sets of output places are replaced with the sets of input places, and vice versa.

The proof for the preservation for the OR property is similar to that for the AND property, except that places are replaced with transitions and vice versa. \square

Lemma 42 (preservation of acyclicity). *The net $M'[S_2 \setminus S_1]$ is acyclic if $M[S_2]$ is acyclic.*

Proof. If $M'[S_2 \setminus S_1]$ contains a cycle, then the edges of this cycle are also present in $M[S_2]$, and so it would also contain a cycle. \square

Lemma 43 (preservation of one-input one-output property). *The net $M'[S_2 \setminus S_1]$ is a one-input one-output net if $M[S_2]$ is a 11tAND or a 11pOR net.*

Proof. We start with proving the one-input property. Let $M[S_2]$ be a 11tAND or a 11pOR net. The proof proceeds by contradiction, so we assume that $M'[S_2 \setminus S_1]$ does not have the one-input property, i.e., there are two distinct nodes n_2 and n_3 in $M'[S_2 \setminus S_1]$ with edges (n_4, n_2) and (n_5, n_3) in M' such that $n_4, n_5 \notin S_2 \setminus S_1$. We then consider the following three cases for the nodes n_4 and n_5 : (i) both are equal to n_1 , (ii) one of them is equal to n_1 and (iii) neither is equal to n_1 .

- (i) This case is illustrated in Figure 9 (a). In this case there must be in $M[S_1]$ an output node n_6 with edges (n_6, n_2) and (n_6, n_3) in M . Note that both edges must exist, since S_1 is assumed to be well-nested in M . We consider the following two cases: (1) $n_6 \in S_1 \cap S_2$ and (2) $n_6 \in S_1 \setminus S_2$:
- (1) The WF net $M'[S_2 \setminus S_1]$ is either a pWF net or a tWF net. In the first case, it follows that n_2 and n_3 are places, since they are input nodes of $M'[S_2 \setminus S_1]$ and n_6 is a transition. By Lemma 40, the I/O type of $M'[S_2 \setminus S_1]$ is equal to that of $M[S_2]$, and so $M[S_2]$ must be a 11pOR net, since by assumption it is either a 11pOR net or a 11tAND net. But this is contradicted by the two distinct edges (n_6, n_2) and (n_6, n_3) in $M[S_2]$, which violate the OR property in regard to the transition t_6 . Similarly, if we assume that $M'[S_2 \setminus S_1]$ is a tWF net, then we can derive that $M[S_2]$ is a 11tAND net, but at the same time the edges (n_6, n_2) and (n_6, n_3) violate the AND property.
- (2) In this case n_2 and n_3 have in M incoming edges from outside S_2 , and so are both input nodes of $M[S_2]$. However, this contradicts the assumption that $M[S_2]$ has the one-input property.
- (ii) This case is illustrated in Figure 9 (b). Without loss of generality we can assume that $n_5 = n_1$ and $n_4 \neq n_1$. By Lemma 39 we know that $S_2 \setminus S_1$ is well-nested in M' , and so the edge (n_4, n_2) implies the edge (n_4, n_3) in M' . Since both edges will also exist in M , it follows that n_2 and n_3 are both input nodes of $M[S_2]$. However, this contradicts the assumption that $M[S_2]$ has the one-input property.
- (iii) This case is illustrated in Figure 9 (c). It proceeds the same as in the previous case.

The one-output property can be shown to be preserved in a similar way, but with the direction of the edges reversed and the sets of input places replaced by the set of output places and vice versa. \square

This concludes the lemmas that show that (1) the well-nestedness of S_2 in M is preserved by $S_2 \setminus S_1$ in M' and (2) all the defining properties of basic AND-OR nets are also preserved in $M'[S_2 \setminus S_1]$ if $M[S_2]$ had them. This leads us to the following lemma.

Lemma 44 (preservation of contractibility). *The subnet $S_2 \setminus S_1$ is contractible in M' .*

Proof. We can show the following three claims: (1) $S_2 \setminus S_1$ is well-nested in M' , (2) $M'[S_2 \setminus S_1]$ is a WF net and (3) $M'[S_2 \setminus S_1]$ belongs to the same basic AND-OR class as $M[S_2]$.

- (1) This follows from Lemma 39.

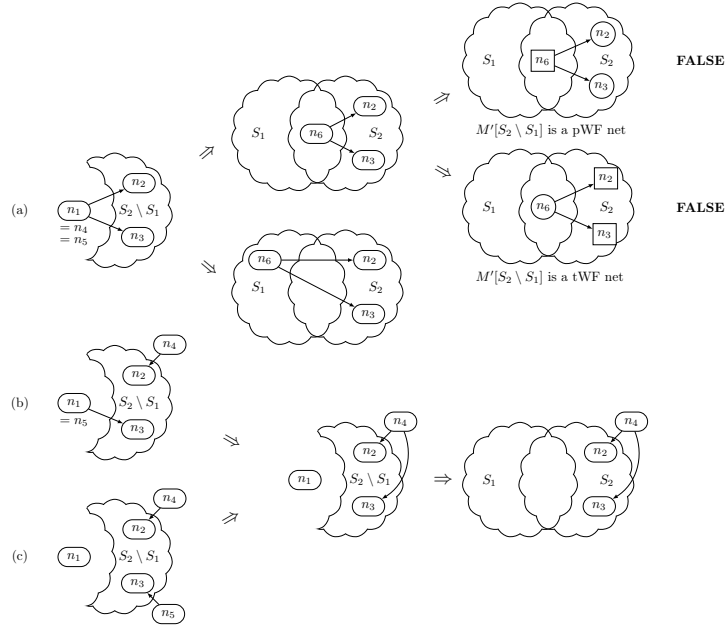

Figure 9: Illustration of proof of preservation of one-input and one-output properties in case (B)

- (2) It follows from Lemma 40 (preservation of I/O type) that $M'[S_2 \setminus S_1]$ is I/O consistent. It then follows that $M'[S_2 \setminus S_1]$ is a WF net, by Theorem 18, which states that every I/O-consistent subnet of a WF net is a WF net, and the fact M' is indeed a WF net, as follows from Theorem 21, which states that the result of a contraction in a WF net is again a WF net.
- (3) This claim follows from the observation that all defining properties of basic AND-OR nets are preserved by $M'[S_2 \setminus S_1]$ if they were satisfied by $M[S_2]$, as is shown by Lemma 40 (preservation of I/O type), Lemma 41 (preservation of the AND and OR properties), Lemma 42 (preservation of acyclicity) and Lemma 43 (preservation of one-input and one-output properties).

□

We now turn to the question if the order of contractions of S_1 and S_2 influences the final result. Before we proceed to the lemma that states this, we present two auxiliary lemmas.

Lemma 45 (no edges from external nodes to nodes in intersection). *In M there are no edges from a node outside $S_1 \cup S_2$ to a node in $S_1 \cap S_2$.*

Proof. If such an edge exists, then its end node is an input node of both $M[S_1]$ and $M[S_2]$, but this contradicts the assumption that the I/O types of $M[S_1]$

and $M[S_2]$ are different. \square

Lemma 46 (shifting of edges). *There is in M an edge from a node in $S_1 \setminus S_2$ to a node in S_2 iff there is in M an edge from a node in S_1 to a node in $S_2 \setminus S_1$.*

Proof. We first consider the *if*-part of the claim. We start with assuming there is in M an edge (n_3, n_4) with $n_3 \in S_1$ and $n_4 \in S_2 \setminus S_1$. If $n_3 \notin S_2$ then the edge (n_3, n_4) is indeed an edge from $S_1 \setminus S_2$ to S_2 . So we proceed under the assumption that $n_3 \in S_2$, and therefore $n_3 \in S_1 \cap S_2$. We now consider the cases (i) all output nodes of $M[S_1]$ are in $S_1 \cap S_2$ and (ii) there is an output node of $M[S_1]$ in $S_1 \setminus S_2$:

- (i) Since $M[S_1]$ is well-connected, and because there is at least one node in $S_1 \setminus S_2$, as S_1 is not nested in S_2 , there must be in $M[S_1]$ a path from that node to an output node in $S_1 \cap S_2$. It follows that there is in that path an edge from a node in $S_1 \setminus S_2$ to a node in $S_1 \cap S_2$.
- (ii) Let this output node of $M[S_1]$ in $S_1 \setminus S_2$ be n_5 . Since n_3 is also an output node of S_1 with the edge (n_3, n_4) to a node outside S_1 , it follows from the well-nestedness of S_1 in M that there is also the edge (n_5, n_4) , which is from a node in $S_1 \setminus S_2$ to S_2 .

The proof for the *only-if*-part of the claim is similar, but with the directions of the edges reversed and the roles of input nodes and output nodes interchanged. \square

Lemma 47 (commutativity of contraction). *Let M_1'' be the result of first contracting S_1 into node n_1 resulting in M_1' followed by contracting $S_2 \setminus S_1$ into node n_2 , and let M_2'' be the result of first contracting S_2 into node n_2 resulting in M_2' followed by contracting $S_1 \setminus S_2$ into node n_1 . Then $M_1'' = M_2''$.*

Proof. The WF nets M_1'' and M_2'' have the same sets of nodes, since in both cases all the nodes of S_1 and S_2 are removed, and the new nodes n_1 and n_2 are added. The types and interconnections of the preserved nodes are not changed by contractions. In addition, the types of n_1 and n_2 will in both cases be the same, which can be shown as follows. Consider the type of n_1 , which is either equal to the I/O type of $M[S_1]$, if this is contracted first, or the I/O type of $M'[S_1 \setminus S_2]$, if $M[S_2]$ is contracted first, but by Lemma 40 it follows that these are the same. By a similar argument, with S_1 and S_2 interchanged, it can be shown that the type of n_2 is in both cases the same.

Since we are only considering internal contractions, the sets of input and output nodes will not change and therefore be in both M_1'' and M_2'' identical to those in M .

So what remains to be shown is that in M_1'' and M_2'' the nodes n_1 and n_2 have (1) the same incoming and outgoing edge and (2) the same edges between them.

- (1) We first consider incoming edges. Assume that in M_1'' there is an edge (n_3, n_1) with $n_3 \neq n_2$. It follows there is in M an edge (n_3, n_4) with n_4 an

input node of $M[S_1]$. By Lemma 45 we know that $n_4 \notin S_1 \cap S_2$. It follows that $n_4 \in S_1 \setminus S_2$, and so the edge (n_3, n_1) will be created when $S_1 \setminus S_2$ is contracted. It follows that this edge exists in M_2'' . By symmetry it also holds that every incoming edge of n_2 in M_2'' also exists in M_1'' .

The proof for outgoing edges is similar, except that the edges are reversed and the sets of input nodes are interchanged with sets of output nodes.

- (2) We first consider edges from n_1 to n_2 . Assume there is an edge (n_1, n_2) in M_1'' . Then there is in M an edge from a node in S_1 to a node in $S_2 \setminus S_1$. By Lemma 46 it follows that there is in M an edge from a node in $S_1 \setminus S_2$ to a node in S_2 . Then there will be an edge (n_1, n_2) in M_2'' . By symmetry it also holds that if there is an edge (n_1, n_2) in M_2'' , then there is also an edge (n_1, n_2) in M_1'' .

The proof for edges from n_2 to n_1 proceeds analogously.

□

5.3 Overlapping, but not nested, subnets with identical I/O types

In this subsection we consider case (C) in Figure 6. Therefore, we assume that S_1 and S_2 are contractible subnets in a WF net M such that (i) they share nodes but not so that one is entirely nested inside the other and (ii) their associated WF nets $M[S_1]$ and $M[S_2]$ have the same I/O type. Let us also assume that M' is the result of contracting S_1 into the node n_1 and M'' the result of contracting S_2 into the node n_2 . Recall that we need to show that (1) after contraction of S_1 into n_1 , the subnet $(S_2 \setminus S_1) \cup \{n_1\}$ is contractible and (2) if we contract first S_1 into n_1 and then $(S_2 \setminus S_1) \cup \{n_1\}$ into n_3 , the result is the same as when we contract first S_2 into n_2 and then $(S_1 \setminus S_2) \cup \{n_2\}$ into n_3 .

Like in the previous subsection, the proof of (1) will consist of a list of lemmas that show that the different properties that define contractibility are all preserved for $(S_2 \setminus S_1) \cup \{n_1\}$ by the contraction of S_1 . We start with the property of well-nestedness, and then move on to the defining properties of WF nets and basic AND-OR nets, and close off with a lemma showing (2).

Lemma 48 (preservation of well-nestedness). *The subnet $(S_2 \setminus S_1) \cup \{n_1\}$ is well-nested in M' .*

Proof. This proof is similar to that of Lemma 39. We first show the well-nestedness for input nodes of $M'[(S_2 \setminus S_1) \cup \{n_1\}]$. For that we need to show that if there are two edges (n_2, n_3) and (n_4, n_5) in M' such that $n_2, n_4 \notin (S_2 \setminus S_1) \cup \{n_1\}$ and $n_3, n_5 \in (S_2 \setminus S_1) \cup \{n_1\}$, then there are edges (n_2, n_5) and (n_4, n_3) in M' . Let us assume that such (n_2, n_3) and (n_4, n_5) exist. We consider the following four cases: (i) both n_3 and n_5 are equal to n_1 , (ii) only one of n_3 and n_5 is equal to n_1 , (iii) neither n_3 nor n_5 is equal to n_1 .

- (i) Since $n_3 = n_1 = n_5$, it holds that $(n_4, n_5) = (n_4, n_1) = (n_4, n_3)$ and that $(n_2, n_3) = (n_2, n_1) = (n_2, n_5)$. So it indeed follows that (n_2, n_5) and (n_4, n_3) exist in M' .
- (ii) We can assume, without loss of generality, that $n_3 = n_1$ and $n_5 \neq n_1$. The reasoning that follows is illustrated in Figure 10. Then, by definition of contraction, there must be an input node n_6 of $M[S_1]$ and an edge (n_2, n_6) in M . We now distinguish two sub-cases, namely that (1) all input nodes of $M[S_1]$ are in $S_1 \setminus S_2$ and (2) there is at least one input node of $M[S_1]$ in $S_1 \cap S_2$. We consider the two cases.
 - (1) If all input nodes of $M[S_1]$ are in $S_1 \setminus S_2$, then so must n_6 . Moreover, it also then holds for all nodes in $S_1 \cap S_2$ that there is a path in $M[S_1]$ to them from a node in $S_1 \setminus S_2$. Take one such path, and take the first edge (n_7, n_8) in that path where $n_7 \in S_1 \setminus S_2$ and $n_8 \in S_1 \cap S_2$. Note that such an edge must exist if the path goes from $S_1 \setminus S_2$ to $S_1 \cap S_2$ and contains only nodes from S_1 . Then, by the well-nestedness of S_2 in M , there is an edge (n_4, n_8) in M , since n_8 and n_5 are both input nodes of $M[S_2]$. Then, it follows that n_8 is an input node of $M[S_1]$, but this contradicts the assumption that all input nodes of $M[S_1]$ are in $S_1 \setminus S_2$, so leads to a contradiction.
 - (2) Because of the well-nestedness of S_2 in M , there are also edges (n_2, n_5) and (n_4, n_6) in M . By the definition of contraction it then follows that there are edges (n_2, n_5) and (n_4, n_1) in M' . Since $n_3 = n_1$, there is then also an edge (n_4, n_3) in M' .
- (iii) So we assume that $n_3 \neq n_1$ and $n_5 \neq n_1$. The reasoning that follows is identical to that for the corresponding case (iii) in the proof for Lemma 39 and is illustrated equally in Figure 8 (b).

The proof for well-nestedness of the output nodes of $M'[(S_2 \setminus S_1) \cup \{n_1\}]$ is similar to that of the input nodes, except that the direction of the edges is reversed and the set of input nodes is replaced with the set of output nodes. \square

Lemma 49 (preservation of I/O type). *The input nodes and output nodes of $M'[(S_2 \setminus S_1) \cup \{n_1\}]$ have the same type as the input nodes and output nodes of $M[S_2]$, respectively.*

Proof. We first consider input nodes. Assume n_2 is an input node of $M'[(S_2 \setminus S_1) \cup \{n_1\}]$, then it will have in M' an incoming edge (n_3, n_2) with $n_3 \notin (S_2 \setminus S_1) \cup \{n_1\}$. Then either (i) $n_2 \in S_2 \setminus S_1$ or (ii) $n_2 = n_1$:

- (i) Then this edge already existed in M , and so n_2 is an input node in $M[S_2]$. Since the type of a node is not changed by contraction, it follows that the type of n_2 is equal to the I/O type of $M[S_2]$.
- (ii) By the definition of contraction the type of n_1 is the I/O type of $M[S_1]$, which is by assumption equal to the I/O type of $M[S_2]$. It follows that the type of $n_2 = n_1$ is equal to the I/O type of $M[S_2]$.

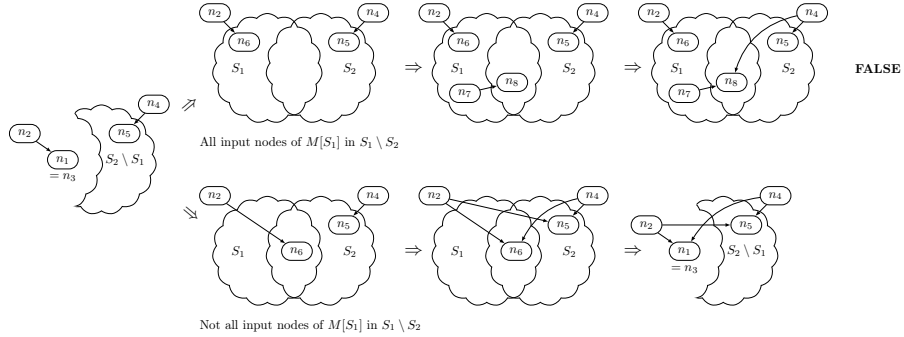

Figure 10: Illustration of proof of preservation of well-nestedness in case (C)

The argument for output nodes is similar, except that edges are reversed and the set of input nodes is replaced with the set of output nodes. \square

Before we proceed with the lemma for the preservation of the AND and OR properties, we introduce an auxiliary lemma about the relationship between S_1 and S_2 .

Lemma 50 (edges only via intersection). *There cannot be edges in M between nodes in $S_1 \setminus S_2$ and nodes in $S_2 \setminus S_1$.*

Proof. If there is such an edge, then its starting node is an output node of one net, and the end node an input node of the other net. Since these nodes must have different types in a Petri net, it follows that the I/O types of two nets are different, but this contradicts the assumption that they are the same. \square

Lemma 51 (preservation of the AND and the OR property). *The net $M'[(S_2 \setminus S_1) \cup \{n_1\}]$ has the AND (OR) property if $M[S_2]$ has the AND (OR) property.*

Proof. We first consider the AND property, and of this first the restriction on incoming edges. The proof proceeds by contradiction, so we start with assuming that $M[S_2]$ has the AND property and $M'[(S_2 \setminus S_1) \cup \{n_1\}]$ does not have the AND property. We will show that it then follows that $M[S_2]$ does *not* have the AND property.

If $M'[(S_2 \setminus S_1) \cup \{n_1\}]$ does not have the AND property, then in $M'[(S_2 \setminus S_1) \cup \{n_1\}]$ there is a place p that violates the AND property. We distinguish two cases: (i) $p \in S_2 \setminus S_1$ or (ii) $p = n_1$.

- (i) The node p can violate the AND property in four ways: (a) it has two distinct incoming edges from nodes in $S_2 \setminus S_1$, (b) it has in $M'[(S_2 \setminus S_1) \cup \{n_1\}]$ an incoming edge from a node in $S_2 \setminus S_1$ and an incoming edge from n_1 , (c) it is an input node of $M'[(S_2 \setminus S_1) \cup \{n_1\}]$ and has in $M'[(S_2 \setminus S_1) \cup \{n_1\}]$ an incoming edge from a node in $S_2 \setminus S_1$ and (d) it is an input node of $M'[(S_2 \setminus S_1) \cup \{n_1\}]$ and has in $M'[(S_2 \setminus S_1) \cup \{n_1\}]$ an incoming edge from n_1 .

- (a) In this case these two edges also exist in $M[S_2]$, and so $M[S_2]$ does not have the AND property.
 - (b) Let (t', p) be the incoming edge from $S_2 \setminus S_1$. Since there is an edge (n_1, p) in M' , there is in M an edge (t'', p) from an output transition t'' of $M[S_1]$ to p . By Lemma 50 it holds that $t'' \in S_1 \cap S_2$. It follows that (t'', p) exists in $M[S_2]$. However, since there is the edge (t', p) in $M'[S_2 \setminus S_1]$ with $t' \in S_2 \setminus S_1$, which necessarily also exists in $M[S_2]$, it follows that in $M[S_2]$ the place p has two distinct incoming edges, and therefore $M[S_2]$ does not have the AND property.
 - (c) If p is an input node of $M'[(S_2 \setminus S_1) \cup \{n_1\}]$ and $pin_{S_2 \setminus S_1}$, then it is also an input node of $M[S_2]$, since we consider internal contractions and an incoming edge in M' from outside $(S_2 \setminus S_1) \cup \{n_1\}$ is necessarily also present in M . The postulated incoming edge in M' from a node in $S_2 \setminus S_1$ is also necessarily present in $M[S_2]$. It follows that in $M[S_2]$ the node p is an input node and has an incoming edge and so the subnet does not have the AND property.
 - (d) Since there is an edge (n_1, p) in M' , there is in M an edge (t'', p) from an output transition t'' of $M[S_1]$ to p . By Lemma 50 the node t'' must be in $S_1 \cap S_2$. It follows that in $M[S_2]$ the node p is an input node and has an incoming edge and so the subnet does not have the AND property.
- (ii) The node $p = n_1$ can violate the AND property in two ways: (a) it has two distinct incoming edges from nodes in $S_2 \setminus S_1$ and (b) it is an input node of $M'[(S_2 \setminus S_1) \cup \{n_1\}]$ and has in $M'[(S_2 \setminus S_1) \cup \{n_1\}]$ an incoming edge from a node in $S_2 \setminus S_1$.
- (a) Let the two distinct incoming edges from nodes in $S_2 \setminus S_1$ be (n_2, p) and (n_3, p) . Then, by the definition of contraction, and since S_1 is well-nested in M , there is an input node n_4 of $M[S_1]$ with two edges (n_2, n_4) and (n_3, n_4) in M . By Lemma 50 the node n_4 must be in $S_1 \cap S_2$. But then n_4 has two distinct incoming edges in $M[S_2]$, and so $M[S_2]$ would not have the AND property.
 - (b) Let (n_2, n_1) be an edge that makes n_1 an input node of $M'[(S_2 \setminus S_1) \cup \{n_1\}]$, which must exist since we consider internal contractions, and so $n_2 \notin (S_2 \setminus S_1) \cup \{n_1\}$. Let (n_3, n_1) be the edge in $M'[(S_2 \setminus S_1) \cup \{n_1\}]$ such that $n_3 \in S_2 \setminus S_1$. From the definition of contraction it follows that there is an input node n_4 of $M[S_1]$, with an edge (n_3, n_4) in M . Because S_1 is well-nested in M , there is also an edge (n_2, n_4) in M . By Lemma 50, the node n_4 must be in $S_1 \cap S_2$. But then n_4 is both an input node of $M[S_2]$, because of (n_2, n_4) , and has in $M[S_2]$ an incoming edge, namely (n_3, n_4) . Therefore $M[S_2]$ does not have the AND property.

The proof for the restriction on the outgoing edges is similar, except that the direction of the edges is reversed and the sets of output places are replaced with the sets of input places, and vice versa.

The proof for the preservation for the OR property is similar to that for the AND property, except that places are replaced with transitions and vice versa. \square

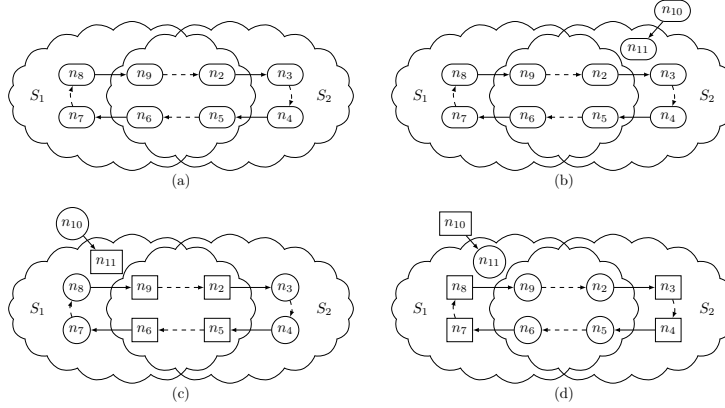

Figure 11: Illustration of proof of preservation of acyclicity

We continue with the lemma that shows the preservation of acyclicity. Note that the premise of this lemma is stronger than in its analogue in case (B), Lemma 42. It not only requires $M[S_2]$ to be acyclic, but to be either a 11tAND net or a pAND net.

Lemma 52 (preservation of acyclicity). *The net $M'[(S_2 \setminus S_1) \cup \{n_1\}]$ is acyclic if $M[S_2]$ is a 11tAND net or a pAND net.*

Proof. The proof proceeds by contradiction, so we assume that there is a cycle in $M'[(S_2 \setminus S_1) \cup \{n_1\}]$, and then show that it follows that there is a cycle in $M[S_2]$. So let us assume that there is a cycle in $M'[(S_2 \setminus S_1) \cup \{n_1\}]$. It is clear that if the cycle does not contain n_1 , then this cycle is also present in $M[S_2]$, so we continue under the assumption that n_1 is contained in the cycle. We can assume that n_1 appears exactly once in the cycle, since if a cycle with multiple occurrences of n_1 exist, then there is also one with exactly one occurrence. In this cycle there must be an edge that leaves n_1 , say (n_1, n_3) , and an edge that arrives in n_1 , say (n_4, n_1) . Note that there is in $M'[S_2 \setminus S_1]$ a path from n_3 to n_4 , or that these nodes are the same node.

Let us now consider the situation in M . Since there are edges (n_1, n_3) and (n_4, n_1) in M' , there must in M be edges (n_2, n_3) and (n_4, n_5) , with n_2 an output node of $M[S_1]$ and n_5 an input node of $M[S_1]$. By Lemma 50 it holds that $n_2, n_5 \in S_1 \cap S_2$. Moreover, since S_1 is well-nested in M there are edges to

n_3 from every output node of $M[S_1]$ and from n_4 to every input node of $M[S_1]$. We can pick n_2 and n_5 such that there is in $M[S_1]$ a path from n_5 to n_2 , which must possible since $M[S_1]$ is well-connected. If this path contains only nodes from $S_1 \cap S_2$, then there is a cycle in $M[S_2]$ that consists of the edge (n_2, n_3) , the path from n_3 to n_4 , the edge from n_4 to n_5 and finally the path from n_5 to n_2 . So we continue under the assumption that the path from n_5 to n_2 contains at least one node from $S_1 \setminus S_2$. This situation is illustrated in Figure 11 (a). In the path from n_5 to n_2 we consider two special edges: the edge (n_6, n_7) that is the first edge that goes from a node in $S_1 \cap S_2$ to a node in $S_1 \setminus S_2$, and the edge (n_8, n_9) that is the last edge that goes from a node in $S_1 \setminus S_2$ to a node in $S_1 \cap S_2$. These edges must exist, since by Lemma 50 the nodes n_2 and n_5 are in $S_1 \cap S_2$. Note that the section of the path between n_7 and n_8 contains only nodes from S_1 , but some of those might be in $S_1 \cap S_2$. Also note that the paths from n_9 to n_2 , and from n_5 to n_6 , contain only nodes in $S_1 \cap S_2$.

Since M is a well-connected, there must for every node in $S_1 \cup S_2$ be a path from an input node of M to that node. Moreover, since S_1 and S_2 are internal subnets, that path contains at least one edge. Taken one such path and let (n_{10}, n_{11}) be the first edge in that path such that $n_{10} \notin S_1 \cup S_2$ and $n_{11} \in S_1 \cup S_2$. It then must hold that (i) $n_{11} \in S_2$ or (ii) $n_{11} \in S_1$. We consider the two cases:

- (i) This case is illustrated in Figure 11 (b). Since S_2 is well-nested in M , there is an edge (n_{10}, n_9) in M as n_9 is an input node of $M[S_2]$. But then n_9 is also an input node of $M[S_1]$ since it has an incoming edge from outside S_1 . Since S_1 is well-nested in M , and n_5 is an input node of $M[S_1]$, there must then be an edge (n_4, n_9) in M . It follows that there must be cycle in $M[S_2]$ through the nodes n_2, n_3, n_4, n_5 and n_9 .
- (ii) This case is illustrated in Figure 11 (c) and (d), where (c) shows the sub-case where $M[S_2]$ is a 11tAND net and (d) shows the sub-case where $M[S_2]$ is a pAND net. We consider these two sub-cases:

$M[S_2]$ is a 11tAND net: Since S_1 is well-nested in M , and n_5 is an input node of $M[S_1]$, there is an edge (n_{10}, n_5) in M . Because of this edge, n_5 is also an input node of S_2 . Since n_9 is also an input node of S_2 , and $M[S_2]$ has exactly one input node, it follows that $n_5 = n_9$. Then, the path in S_2 that goes through the nodes n_2, n_3, n_4, n_5 and n_9 , is in fact a cycle.

$M[S_2]$ is a pAND net: As in the previous sub-case, we derive that n_5 is an input node of S_2 . But then n_5 violates the AND property since it is both an input node of $M[S_2]$ and has in $M[S_2]$ an incoming edge, which contradicts the assumption that $M[S_2]$ is a pAND net.

□

Lemma 53 (preservation of one-input one-output property). *The net $M'[(S_2 \setminus S_1) \cup \{n_1\}]$ is a one-input one-output net if $M[S_2]$ is a one-input one-output net.*

Proof. We start with proving the one-input property. The proof proceeds by contradiction, so we start with assuming that $M'[(S_2 \setminus S_1) \cup \{n_1\}]$ does not have the one-input property, i.e., there are two distinct nodes n_3 and n_5 in $M'[(S_2 \setminus S_1) \cup \{n_1\}]$ with edges (n_2, n_3) and (n_4, n_5) in M' such that $n_2, n_4 \notin (S_2 \setminus S_1) \cup \{n_1\}$. We then consider the following two cases for the distinct nodes n_3 and n_5 : (i) one of them is equal to n_1 and (ii) neither is equal to n_1 .

(i) This case is illustrated in Figures 12 (a). Without loss of generality, we can assume that $n_5 = n_1$ and $n_3 \neq n_1$. By definition of contraction, there is then in M a node n_6 that is an input node of $M[S_1]$ and an edge (n_4, n_6) . We consider the cases (1) all input nodes of $M[S_1]$ are in $S_1 \setminus S_2$ and (2) there is at least one input node of $M[S_1]$ that is in $S_1 \cap S_2$:

(1) Because $M[S_1]$ is well-connected, the nodes in $S_1 \cap S_2$ must be reachable via a path from an input node of $M[S_1]$ in $S_1 \setminus S_2$. Take one such path, and consider the first edge (n_7, n_8) on that path such that $n_7 \in S_1 \setminus S_2$ and $n_8 \in S_1 \cap S_2$. It follows that n_8 is an input node of $M[S_2]$, because it has an incoming edge from outside S_2 . The node n_3 is also an input node of $M[S_2]$ because of the edge (n_2, n_3) . Since $n_8 \in S_1 \cap S_2$ and $n_3 \in S_2 \setminus S_1$, they are distinct nodes, and so $M[S_2]$ does not have the one-input property.

(2) Because S_1 is well-nested in M , we can reassign n_6 such that it is in $S_1 \cap S_2$ and still has an incoming edge from n_4 . It then follows that n_6 is an input node of $M[S_2]$, as well as n_3 . Since $n_6 \in S_1 \cap S_2$ and $n_3 \in S_2 \setminus S_1$, they are distinct nodes, and so $M[S_2]$ does not have the one-input property.

(ii) This case is illustrated in Figures 12 (b). It follows that n_3 and n_5 are input nodes of $M[S_2]$, but then $M[S_2]$ does not have the one-input property.

The one-output property can be shown to be preserved in a similar way, but with the direction of the edges reversed and the sets of input places replaced by the sets of output places and vice versa. \square

This concludes the lemmas that show that (1) the well-nestedness of S_2 in M is preserved by $S_2 \setminus S_1$ in M' and (2) all the defining properties of basic AND-OR nets are also preserved in $M'[S_2 \setminus S_1]$ if $M[S_2]$ had them. This leads us to the following lemma.

Lemma 54 (preservation of contractibility). *The subnet $(S_2 \setminus S_1) \cup \{n_1\}$ is contractible in M' .*

Proof. The proof proceeds analogous to that of Lemma 44, which show preservation of contractibility for case (B). We show the following three claims: (1) $M'[(S_2 \setminus S_1) \cup \{n_1\}]$ is well-nested, (2) $M'[(S_2 \setminus S_1) \cup \{n_1\}]$ is a WF net and (3) $M'[(S_2 \setminus S_1) \cup \{n_1\}]$ belongs to the same basic AND-OR class as $M[S_2]$. Claim (1) follows from Lemma 48. Claim (2) follows from Lemma 49 (preservation of I/O type), Theorem 18 (every I/O-consistent subnet of a WF net is a WF net)

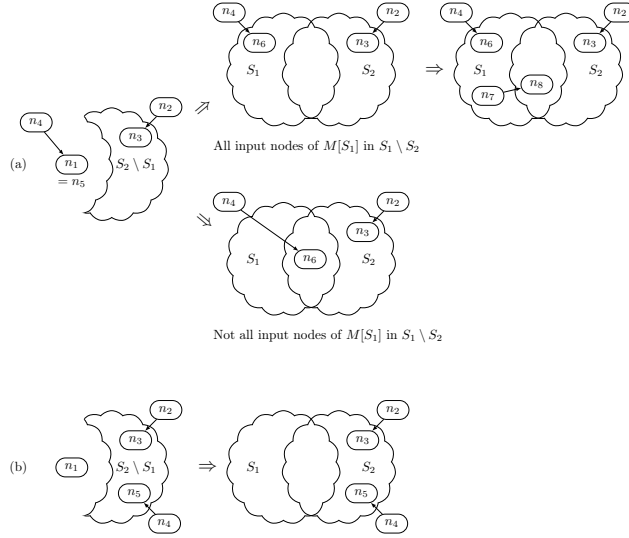

Figure 12: Illustration of proof of preservation of the one-input and one-output properties in case (C)

and Theorem 21 (the result of a contraction in a WF net is a WF net). Claim (3) follows from the preservation of the AND-OR defining properties of $M[S_2]$ by $M'[(S_2 \setminus S_1) \cup \{n_1\}]$, as stated by Lemma 49 (preservation of I/O type), Lemma 51 (preservation of the AND and OR properties), Lemma 52 (preservation of acyclicity) and Lemma 53 (preservation of one-input and one-output properties). \square

We now turn to the question if the order of contractions of S_1 and S_2 influences the final result.

Lemma 55 (commutativity of contraction). *Let M_1'' be the result of first contracting S_1 into node n_1 resulting in M_1' followed by contracting $(S_2 \setminus S_1) \cup \{n_1\}$ into node n_3 , and let M_2'' be the result of first contracting S_2 into node n_2 resulting in M_2' followed-by contracting $(S_1 \setminus S_2) \cup \{n_2\}$ into node n_3 . Then $M_1'' = M_2''$.*

Proof. The WF nets M_1'' and M_2'' have the same sets of nodes, since in both cases all the nodes of S_1 and S_2 are removed, and the new node n_3 is added. The types of the preserved nodes are not changed by contractions. In addition, the type of n_3 will in both cases be the same, which can be shown as follows. In M_1'' the type of n_3 is the I/O type of $M_1'[(S_2 \setminus S_1) \cup \{n_1\}]$, which by Lemma 49 is the I/O type of S_2 in M . Similarly, in M_2'' the type of n_3 is equal to the I/O type of S_1 . Since the I/O types of S_1 and S_2 are assumed to be the same, the type of n_3 in M_1'' and in M_2'' is also the same.

Since we are only considering internal contractions, the sets of input and output nodes will not change, and therefore be in both M_1'' and M_2'' identical to those in M .

So what remains to be shown is that in M_1'' and M_2'' the node n_3 has the same incoming and outgoing edges. For incoming edges it is easy to see that in both M_1'' and M_2'' it holds that an edge (n_4, n_3) exists iff $n_4 \notin S_1 \cup S_2$ and there is a node $n_5 \in S_1 \cup S_2$ such that the edge (n_4, n_5) exists in M . A similar argument, but with the direction of the edges reversed, can be made for outgoing edges. \square

5.4 Nested subnets

In this subsection we consider case (D) in Figure 6. Therefore, we assume that S_1 and S_2 are contractible subnets in a WF net M such that $S_2 \subseteq S_1$. Let us also assume that M' is the result of contracting S_2 into the node n_2 and M'' is the result of contracting S_1 into the node n_1 . Recall that we need to show that (1) after contraction of S_2 into n_2 , the subnet $(S_1 \setminus S_2) \cup \{n_2\}$ is contractible in M' and (2) if we contract first S_2 into n_2 and then $(S_1 \setminus S_2) \cup \{n_2\}$ into n_1 , the result is the same as when we contract first S_1 into n_1 .

Like in the previous subsection, the proof of (1) will consist of a list of lemmas that show that the different properties that define contractibility are all preserved for subnet $(S_1 \setminus S_2) \cup \{n_2\}$ by the contraction of S_2 . We start with the property of well-nestedness, and then move on to the defining properties of WF nets and basic AND-OR nets, and close off with a lemma showing (2).

Lemma 56 (preservation of well-nestedness). *The subnet $(S_1 \setminus S_2) \cup \{n_2\}$ is well-nested in M' .*

Proof. This proof proceeds the same as for the analogous Lemma 48 for case (C), except that S_1 and S_2 reverse roles and n_1 is replaced with n_2 . This is because that proof does in fact not use the assumptions that the nets are not nested and that their I/O types are the same. \square

Lemma 57 (preservation of I/O type). *The input nodes and output nodes of $M'[(S_1 \setminus S_2) \cup \{n_2\}]$ have the same type as the input nodes and output nodes of $M[S_2]$, respectively.*

Proof. This proof proceeds the same as for the analogous Lemma 49 for case (C), except that S_1 and S_2 reverse roles and n_1 is replaced with n_2 . This is because that proof does not use the assumptions that the nets are not nested and that their I/O types are the same. \square

Lemma 58 (preservation of the AND and the OR property). *The net $M'[(S_1 \setminus S_2) \cup \{n_2\}]$ has the AND (OR) property if $M[S_1]$ has the AND (OR) property.*

Proof. This proof proceeds the same as for the analogous Lemma 51 for case (C), except that (1) S_1 and S_2 reverse roles and n_1 is replaced with n_2 and (2) wherever it uses Lemma 50, which states that there are no edges between nodes

in $S_1 \setminus S_2$ and nodes in $S_2 \setminus S_1$, this is replaced with the observation that by assumption there are no nodes in $S_2 \setminus S_1$. This works because that proof does not use the assumptions that the nets are not nested and that their I/O types are the same. \square

Lemma 59 (preservation of acyclicity). *The net $M'[(S_1 \setminus S_2) \cup \{n_2\}]$ is acyclic if $M[S_1]$ is acyclic.*

Proof. The proof proceeds by contradiction, so we assume that there is a cycle in $M'[(S_1 \setminus S_2) \cup \{n_2\}]$, and then show that it follows that there is a cycle in $M[S_1]$. So let us assume that there is a cycle in $M'[(S_1 \setminus S_2) \cup \{n_2\}]$. It is clear that if the cycle does not contain n_2 , this cycle is also present in $M[S_1]$, so we continue under the assumption that n_2 is contained in the cycle. We can assume that n_2 appears exactly once in the cycle, since if a cycle with multiple occurrences of n_2 exist, then there is also one with exactly one occurrence. In this cycle there must be an edge that leaves n_2 , say (n_2, n_3) , and an edge that arrives in n_2 , say (n_4, n_2) . Note that there is in $M'[S_1 \setminus S_2]$ a path from n_3 to n_4 , possibly consisting of only one node, in which case these nodes are one and the same.

Since $M[S_2]$ is a WF net, it will contain a path from an input node, say n_5 , to an output node, say n_6 . By the definition of contraction, and since S_2 is well-nested in M , it follows that there are edges (n_4, n_5) and (n_6, n_3) in M . It then follows that there is a cycle in $M[S_1]$ through the nodes n_3, n_4, n_5 and n_6 . \square

Lemma 60 (preservation of one-input one-output property). *The net $M'[(S_1 \setminus S_2) \cup \{n_2\}]$ is a one-input one-output net if $M[S_1]$ is a one-input one-output net.*

Proof. This proof proceeds the same as for the analogous Lemma 53 for case (C), except that S_1 and S_2 reverse roles and n_1 is replaced with n_2 . This is because that proof does not use the assumptions that the nets are not nested and that their I/O types are the same. \square

This concludes the lemmas that show that (1) the well-nestedness of $M[S_2]$ is preserved by $M'[S_2 \setminus S_1]$ and (2) all the defining properties of basic AND-OR nets are also preserved in $M'[S_2 \setminus S_1]$ if $M[S_2]$ had them. This leads us to the following lemma.

Lemma 61 (preservation of contractibility). *The subnet $(S_1 \setminus S_2) \cup \{n_2\}$ is contractible in M' .*

Proof. The proof proceeds analogous to that of Lemma 61, which shows preservation of contractibility for case (C). We show the following three claims: (1) $M'[(S_1 \setminus S_2) \cup \{n_2\}]$ is well-nested, (2) $M'[(S_1 \setminus S_2) \cup \{n_2\}]$ is a WF net and (3) $M'[(S_1 \setminus S_2) \cup \{n_2\}]$ belongs to the same basic AND-OR class as $M[S_1]$. Claim (1) follows from Lemma 56. Claim (2) follows from Lemma 57 (preservation of I/O type), Theorem 18 (every I/O-consistent subnet of a WF net is a WF net)

and Theorem 21 (the result of a contraction in a WF net is a WF net). Claim (3) follows from the preservation of the AND-OR defining properties of $M[S_2]$ by $M'[(S_1 \setminus S_2) \cup \{n_2\}]$, as stated by Lemma 57 (preservation of I/O type), Lemma 58 (preservation of the AND and OR properties), Lemma 59 (preservation of acyclicity) and Lemma 60 (preservation of one-input and one-output properties). \square

We now turn to the question if the order of contractions of S_1 and S_2 influences the final result.

Lemma 62 (commutativity of contraction). *Let M_1'' be the result of contracting S_1 into node n_1 , and let M_2'' be the result of first contracting S_2 into node n_2 resulting in M' followed by contracting $(S_1 \setminus S_2) \cup \{n_2\}$ into node n_1 . Then $M_1'' = M_2''$.*

Proof. The WF nets M_1'' and M_2'' have the same sets of nodes, since in both cases all the nodes of S_1 and S_2 are removed, and the new node n_1 is added. The types of the preserved nodes are not changed by contractions. In addition, the type of n_1 will in both cases be the same, which can be shown as follows. In M_1'' the type of n_1 is the I/O type of S_1 . Similarly, in M_2'' the type of n_1 is equal to the I/O type of $M'[(S_1 \setminus S_2) \cup \{n_2\}]$, which by Lemma 57 has the same I/O type as $M[S_1]$.

Since we are only considering internal contractions, the sets of input and output nodes will not change, and therefore be in both M_1'' and M_2'' identical to those in M .

So what remains to be shown is that in M_1'' and M_2'' the node n_1 has the same incoming and outgoing edges. For incoming edges it is easy to show that in both M_1'' and M_2'' it holds that an edge (n_3, n_1) exists iff $n_3 \notin S_1 \cup S_2$ and there is a node $n_4 \in S_1 \cup S_2$ such that the edge (n_3, n_4) exists in M . A similar argument, but with the direction of the edges reversed, can be made for outgoing edges. \square

5.5 Combining all cases

In the preceding subsections it was shown for the cases (A), (B), (C) and (D) from Figure 6 that for internal contractions we have local confluence. We now combine these results to show that this holds in general for every two internal AND-OR contractions.

Theorem 63 (local confluence of the internal AND-OR contraction relation). *Given a WF net M and two AND-OR contractions $M \rightsquigarrow_{int} M'_1$ and $M \rightsquigarrow_{int} M'_2$, there is a WF net M'' such that $M'_1 \rightsquigarrow_{int}^* M''$ and $M'_2 \rightsquigarrow_{int}^* M''$.*

Proof. Let $M[S_1]$ and $M[S_2]$ be the subnets of M that were contracted for $M \rightsquigarrow_{int} M'_1$ and $M \rightsquigarrow_{int} M'_2$, respectively. The easiest case to consider is the case where these nets do not share nodes and are not connected by edges. In that case, the contraction of one net does not influence the other subnet or its connected edges, and so each of $M[S_1]$ and $M[S_2]$ will stay contractible if

the other is contracted, and the final result after contracting both nets does not depend upon the order of contraction.

The remaining cases were defined in the beginning of this section, and for convenience we recall them here. In each case the following holds for $M[S_1]$ and $M[S_2]$:

- (A) *They do not share nodes, but there are edges from nodes in one subnet to nodes in another.* By Lemma 37 it holds that after contracting S_1 into n_1 resulting in M'_1 the subnet S_2 is contractible in M'_1 . By symmetry the same holds for the subnet S_1 if we contract S_2 into n_2 resulting in M'_2 . Moreover, by Lemma 38 it holds that the result of contracting first S_1 into n_1 and then S_2 into n_2 is the same as when we first contract S_2 into n_2 and then S_1 into n_1 .
- (B) *The subnets share nodes, the corresponding WF nets have different I/O types, and each subnet has nodes that are not contained in the other.* By Lemma 44 it holds that after contracting S_1 into n_1 resulting in M'_1 the subnet $S_2 \setminus S_1$ is contractible in M'_1 . By symmetry the same holds for the subnet $S_1 \setminus S_2$ in M'_2 if we contract S_2 into n_2 resulting in M'_2 . Moreover, by Lemma 47 it holds that the result of contracting first S_1 into n_1 and then $S_2 \setminus S_1$ into n_2 , is the same as when we first contract S_2 into n_2 and then $S_1 \setminus S_2$ into n_1 .
- (C) *The subnets share nodes, the corresponding WF nets have the same I/O type, and each subnet has nodes that are not contained in the other.* By Lemma 54 it holds that after contracting S_1 into n_1 resulting in M'_1 the subnet $(S_2 \setminus S_1) \cup \{n_1\}$ is contractible in M'_1 . By symmetry the same holds for the subnet $(S_1 \setminus S_2) \cup \{n_2\}$ in M'_2 if we contract S_2 into n_2 resulting in M'_2 . Moreover, by Lemma 55 it holds that the result of contracting first S_1 into n_1 and then $(S_2 \setminus S_1) \cup \{n_1\}$ into n_3 is the same as when we first contract S_2 into n_2 and then $(S_1 \setminus S_2) \cup \{n_2\}$ into n_3 .
- (D) *One subnet is contained in the other.* Without loss of generality we assume that $S_2 \subseteq S_1$. By Lemma 61 it holds that after contracting S_2 into n_2 resulting in M'_2 the subnet $(S_1 \setminus S_2) \cup \{n_2\}$ is contractible in M'_2 . Moreover, by Lemma 62 it holds that the result of contracting S_1 into n_1 is the same as when we first contract S_2 into n_2 and then $(S_1 \setminus S_2) \cup \{n_2\}$ into n_1 .

Summarising, we have shown that in cases (A), (B) and (C) there is a WF net M'' such that $M'_1 \rightsquigarrow_{\text{int}} M''$ and $M'_2 \rightsquigarrow_{\text{int}} M''$, and so it follows that $M'_1 \rightsquigarrow_{\text{int}}^* M''$ and $M'_2 \rightsquigarrow_{\text{int}}^* M''$. Moreover, in case (D) we have shown that $M'_2 \rightsquigarrow_{\text{int}} M'_1$, and so there is indeed a WF net $M'' = M'_1$ such that $M'_1 \rightsquigarrow_{\text{int}}^* M''$ and $M'_2 \rightsquigarrow_{\text{int}}^* M''$. \square

Lemma 64 (simulation with internal AND-OR contractions). *If M_1 and M_2 are tWF nets and M'_1 and M'_2 their place completions, it holds that $M_1 \rightsquigarrow M_2$ iff $M'_1 \rightsquigarrow_{\text{int}} M'_2$, and the same holds if M_1 and M_2 are pWF nets and M'_1 and M'_2 their transition completions.*

Proof. We start by showing that if M_1 and M_2 are tWF nets and M'_1 and M'_2 their place completions, it holds that $M_1 \rightsquigarrow M_2$ iff $M'_1 \rightsquigarrow_{\text{int}} M'_2$. Let the special input and output nodes in a place completion be p_i and p_o .

It is easy to observe that the following two statements are equivalent: (a) n is an input node in M_1 and (b) there is an edge (p_i, n) in M'_1 . Similarly, the following two are also equivalent: (c) n is an output node in M_1 and (d) there is an edge (n, p_o) in M'_1 .

It follows that a subnet S is well-nested in M_1 iff S is internal well-nested in M'_1 . After all, a set of nodes in M_1 have all the same incoming edges in M'_1 from nodes outside S iff (1) they have all the same incoming edges in M_1 from outside S and (2) either are all input nodes of M_1 or are all not input nodes of M_1 . Similarly, they have all the same outgoing edges in M'_1 to nodes outside S iff (1) they have all the same outgoing edges in M_1 to nodes outside S and (2) either are all output nodes of M_1 or are all not output nodes of M_1 .

Moreover, a subnet S defines a basic AND-OR net in M_1 iff it does in M'_1 . This follows from the observation that in the definitions of the AND and the OR property, having an incoming edge from outside S and being an input node of M_1 are treated equivalently. So we can conclude that subnet S is contractible in M_1 iff S is internally contractible in M'_1 .

If we then consider what happens if we contract S in M_1 and S in M'_1 , then the same happens in terms of changes to edges and nodes, except that where in M_1 the new node n_1 becomes an input or output node, it holds in M'_1 that the edge (p_i, n_1) or the edge (n_1, p_o) is added, respectively. This indeed commutes with taking the place completion.

The proof for the case where M_1 and M_2 are pWF nets, with M'_1 and M'_2 their transition completions, is similar, but with the roles of transitions and places interchanged. \square

This leads us to the proof of Theorem 25, which states that the AND-OR contraction relation has the local confluence property. We recall its content here before giving its proof.

Theorem 25. (local confluence of the AND-OR contraction relation)

For all WF nets M , M_1 and M_2 it holds that if $M \rightsquigarrow M_1$ and $M \rightsquigarrow M_2$, then there is a WF net M_3 such that $M_1 \rightsquigarrow^* M_3$ and $M_2 \rightsquigarrow^* M_3$.

Proof. Let M , M_1 and M_2 be WF nets such that it holds $M \rightsquigarrow M_1$ and $M \rightsquigarrow M_2$. We are going to first deal with the case where M is a tWF net. By Theorem 21 it follows that M_1 and M_2 are also tWF nets. By Lemma 64 it follows that $\mathbf{pc}(M) \rightsquigarrow_{\text{int}} \mathbf{pc}(M_1)$ and $\mathbf{pc}(M) \rightsquigarrow_{\text{int}} \mathbf{pc}(M_2)$. Now by Theorem 63 we know that there is a WF net M'' such that $\mathbf{pc}(M_1) \rightsquigarrow_{\text{int}}^* M''$ and $\mathbf{pc}(M_2) \rightsquigarrow_{\text{int}}^* M''$. Again by Theorem 21 and induction on the number of contractions, we know that M'' is a pWF net. Furthermore, as it is a result of internal AND-OR contractions applied to a one-input one-output net, it is a one-input one-output net and as there were distinct input and output nodes and some other nodes (M cannot be empty) before the contraction, this is still

the case in M'' . Thus $M'' = \mathbf{pc}(M_3)$ for some net M_3 . Using the Lemma 64 again, from $\mathbf{pc}(M_1) \rightsquigarrow_{\text{int}}^* M'' = \mathbf{pc}(M_3)$ and $\mathbf{pc}(M_2) \rightsquigarrow_{\text{int}}^* M'' = \mathbf{pc}(M_3)$, we get with induction on the number of contraction steps that $M_1 \rightsquigarrow^* M_3$ and $M_2 \rightsquigarrow^* M_3$.

The proof for the case were M is a pWF net proceeds similar, but with taking transition completion rather than place completion. \square

6 A polynomial-time reduction algorithm

In this section we present a concrete AND-OR reduction algorithm for computing the net-based AND-OR reduction procedure. In addition we show how this algorithm can be used to verify if a certain WF net is an AND-OR net. The algorithm is based on the result of Theorem 36 which states that the result of this reduction is unique up to isomorphism, no matter how we select the subnets to contract. This allows the algorithm to proceed without backtracking and essentially just repeat a process where it continues to look for contractible non-trivial subnets, and contract them, until no more such subnets can be found. The efficiency of this algorithm is improved further by an algorithm for identifying such subnets within polynomial time. As a result the whole reduction algorithm runs within polynomial time.

Algorithm 1: reduce(M)

Input: a net WF net $M = (P, T, F, I, O)$

Output: a net-based AND-OR reduction of M

```

1 foreach  $(n_1, n_2) \in (P \times P) \cup (T \times T)$  do
2   if  $n_1 = n_2$  and  $n_1 \in P$  and there exists  $t \in T$  s.t.  $t \bullet_M = \bullet_M t = \{n_1\}$ 
   then
3     return reduce(contractSubnet( $M, \{n_1, t\}$ ));
4   if  $n_1 \neq n_2$  and  $\bullet_M n_1 = \bullet_M n_2$  and  $n_1 \bullet_M = n_2 \bullet_M$  then
5     return reduce(contractSubnet( $M, \{n_1, n_2\}$ ));
6   if  $n_1 \neq n_2$  and  $n_2$  is reachable from  $n_1$  then
7      $N \leftarrow$  expand( $M, n_1, n_2$ );
8     if  $N \neq \text{null}$  then
9       return reduce(contractSubnet( $M, N$ ));
10 return  $M$ ;

```

6.1 The reduction algorithm

Non-trivial subnets, i.e., subnets with more than one node, for contraction can be found in the following way. We iterate in line 1 of Algorithm 1 over all the pairs of nodes (n_1, n_2) of the same type, i.e., pairs of places or pairs of

transitions. We distinguish three cases. We start in line 2 with contracting loops, where by a loop we mean a place with a transition attached to it such that this transition has exactly two edges, one incoming from the place and one outgoing to the place. Then in line 4 we contract pairs of distinct nodes if these share the same incoming and outgoing edges. Finally, in line 6, for the remaining pairs of nodes we treat one node as an input and the other as an output. We expand forward from the input node and backward from the output node. While expanding we remember that we can discover new interface nodes. If we end up with a subnet that is of a basic AND-OR class then we contract it.

It can be shown that if any non-trivial subnet can be contracted, then at least one of our three cases will also find a subnet. This follows from the observation that for a contractible subnet it holds either (1) it has an input node and an output node that is distinct from the input node but can be reached from it or (2) all input nodes are also output nodes and vice versa. Case (1) is covered by the test on line 6 where we assume that n_1 is an input node and n_2 an output node of the subnet we are looking for. For case (2) we can distinguish the sub-cases (a) there are two or more input/output nodes or (b) there is exactly one input/output node. In case (a) the test on line 4 will apply. In case (b) it can be observed that the nested net must be an 11pOR net if it is non-trivial. This is because it then contains a cycle, and so cannot be an 11tAND or pAND net, and it also cannot be a tOR net since the input/output node has incoming and outgoing edges. If it is an 11pOR net then it either satisfies the test on line 2, or the net minus the input/output place defines a well-nested tOR net containing more than one node and which is covered by either the tests on line 4 or 6. So we can conclude that if there is a contractible subnet then there is a pair (n_1, n_2) that satisfies at least one of the tests on line 2, 4, or 6.

The loop runs in quadratic time. Each time we do a contraction the number of nodes decreases, so it suffices to show that we can do the expansion in polynomial time. Observe first that we can easily check in polynomial time if the output node is reachable from an input node or even enumerate the nodes in such a way that for each input node we iterate only over the output nodes reachable from it.

The expansion can be done as in Algorithm 2. Given an input and output node pair we traverse the net as in a breadth or depth-first graph search algorithm. The initial nodes for the traversal are the input and output nodes provided as parameters, yet we make sure that we traverse forward only if the currently inspected node is not an output node (see lines 7 through 12) and that we traverse backward only if the currently inspected node is not an input node (see lines 13 through 18). The newly encountered nodes are tested to check if they can be input (output) nodes of the subnet we are looking for. This is done by testing if (1) they have incoming (outgoing) edges from (to) exactly the same nodes as the initial input (output) node and (2) are input node of M iff the initial input node is an input node of M . When this test succeeds, the node is added to the input (output) set of the constructed net (see lines 9 and 15).

It is easy to see, that during the traversal we discover only nodes that must

Algorithm 2: $\text{expand}(M, i, o)$

Input: a WF net $M = (P, T, F, I, O)$ and nodes $i, o \in P$ or $i, o \in T$

Output: a set S of nodes of M such that $M[S]$ is a well-nested subnet in M that is a WF net of a basic AND-OR class with input node i and output node o , or *null* if such a subnet does not exist

```
1  $(S, I_S, O_S) \leftarrow (\{i, o\}, \{i\}, \{o\});$  // init.  $S$  and input/output sets of  $M[S]$ 
2  $TBA \leftarrow \{i, o\};$  // nodes to be analysed
3 if  $i, o \in P$  then  $PC \leftarrow \{11pOR, pAND\};$  // init. set of possible
4 if  $i, o \in T$  then  $PC \leftarrow \{11tAND, tOR\};$  // basic AND-OR classes
5 while  $TBA \neq \emptyset$  and  $PC \neq \emptyset$  do
6    $n' \leftarrow$  pick and remove from  $TBA$ ;
7   if  $\bullet_M n' = \bullet_M i$  and  $n' \in I \Leftrightarrow i \in I$  then // is  $n'$  input node?
8     if  $n' \notin I_S$  then  $PC \leftarrow PC \setminus \{11pOR, 11tAND\};$  // new input
9      $I_S \leftarrow I_S \cup \{n'\};$ 
10  else
11     $TBA \leftarrow TBA \cup (\bullet_M n' \setminus S);$  // add predecessors
12     $S \leftarrow S \cup \bullet_M n'$ ;
13  if  $n' \bullet_M = o \bullet_M$  and  $n' \in O \Leftrightarrow o \in O$  then // is  $n'$  output node?
14    if  $n' \notin O_S$  then  $PC \leftarrow PC \setminus \{11pOR, 11tAND\};$  // new output
15     $O_S \leftarrow O_S \cup \{n'\};$ 
16  else
17     $TBA \leftarrow TBA \cup (n' \bullet_M \setminus S);$  // add followers
18     $S \leftarrow S \cup n' \bullet_M$ ;
19  if  $(n' \notin I_S \wedge |\bullet_{M[S]} n'| \neq 1)$  or  $(n' \in I_S \wedge |\bullet_{M[S]} n'| \neq 0)$  or
20   $(n' \notin O_S \wedge |n' \bullet_{M[S]}| \neq 1)$  or  $(n' \in O_S \wedge |n' \bullet_{M[S]}| \neq 0)$  then
21    if  $n' \in P$  then  $PC \leftarrow PC \setminus \{pAND, 11tAND\};$  // not AND net
22    if  $n' \in T$  then  $PC \leftarrow PC \setminus \{tOR, 11pOR\};$  // not OR net
23 if  $M[S]$  cyclic then  $PC \leftarrow PC \setminus \{pAND, 11tAND\};$  // AND is acyclic
24 if  $PC = \emptyset$  then return null; // no more possible basic classes?
25 return  $S$ ;
```

be in any well-nested subnet with the provided interface nodes. This holds because, if there is in M an edge (n_1, n_2) , and n_1 is in a subnet that is a WF net, but cannot be an output node of that WF net, then n_2 is also in that subnet. So we argue that the algorithm finds only non-trivial subnets that are well-nested and of a basic AND-OR class. Otherwise it returns *null*.

First, observe that in lines 7 and 13 we check if a node has incoming (outgoing) edges from (to) exactly the same nodes as the initial input (output) node. However, for a well-nested subnet S it is required that all nodes in I_S (O_S) must have incoming (outgoing) edges from (to) the same nodes *outside* S . We argue that our check is correct, which can be reasoned by examining all the basic AND-OR classes. For pAND and 11tAND nets no cycles are allowed, so for input (output) nodes all incoming (outgoing) edges must come from outside. In tOR nets transitions have at most one incoming (outgoing) edges internally and

none if they are input (output) node, so all incoming edges come from outside. Finally, for 11pOR nets only the initial single input and single output nodes are possible and no other internal node can have edges from outside. Now we know that if a subnet is found, it must be a WF net, since (1) M is assumed to be a WF net, (2) all the input (output) nodes are guaranteed to be connected to the same nodes outside and either all input (output) node of M or none, and (3) we include all the nodes reachable forwards (backwards) from any of the input (output) nodes.

Next, during traversal, we maintain the set of possible basic AND-OR classes that are still compatible with the discovered net. It is initiated in the lines 3 through 4, can be updated in lines 8 and 14 if the expanded net is observed to not to be one input one output net, respectively, and in lines 21 and 22 if the AND or OR properties, respectively, stop to be satisfied. Note that if n' here satisfies the AND and OR properties it will continue to do so, since all its predecessors and successors have already been added to S in the preceding steps on lines 12 and 18 unless it is an input or output node. Finally, on line 23 we examine the acyclicity property, which is required for AND nets. This guaranties that we know if the subnet is of a basic AND-OR class. If no compatible basic AND-OR classes are left (see line 24), a *null* is returned.

At the end of the algorithm, on line 25 the found subnet is returned, which is spanned by S and is a well-nested, internal subnet of M that is in at least one basic AND-OR class. This concludes the argument for correctness of Algorithm 2.

6.2 Using the reduction algorithm for verifying AND-OR nets

The presented algorithm can also be used to determine if a WF net is an AND-OR net or not. This is because the result of the algorithm is a one-node WF net iff the input is an AND-OR net. To show this, we first present a characterisation of AND-OR nets in terms of AND-OR reductions.

Theorem 65 (AND-OR net bottom-up characterisation). *A WF net M is and AND-OR net iff there is a one-node WF net M' such that $M \rightsquigarrow^* M'$.*

Proof. The *if*-part follows straightforwardly from the definition of AND-OR nets and the observation that contractions are the inverse of substitutions.

The *only-if*-part can be shown as follows. If M is an AND-OR net there is substitution expression, e.g., $(A \otimes_{n_1} B) \otimes_{n_2} (C \otimes_{n_3} D)$, with all mentioned nets being basic AND-OR nets. Since substitution is associative this will be equivalent with a substitution expression where all brackets are moved to the left, e.g., $((A \otimes_{n_1} B) \otimes_{n_2} C) \otimes_{n_3} D$. It follows that we can reverse the substitutions and perform them as contractions in reverse, e.g., we contract D , C , B and A in that order, and then obtain a one-node WF net. \square

Finally, we show that this characterisation coincides with the net-based

AND-OR reduction, which is what the algorithm computes, returning a one-node WF net.

Theorem 66 (equivalence of the reductions for AND-OR net verification). *Given a WF net M , the following statements are equivalent:*

- (i) *The application of the net-based AND-OR reduction to M results in a one-node WF net.*
- (ii) *The application of the class-based AND-OR reduction to M results in a class of one-node WF nets.*
- (iii) *The WF net M can be reduced to a one-node WF net by zero or more contractions.*

Proof. It is easy to see that (i) implies (iii), since a net-based AND-OR reduction is in fact a series of contractions. That (ii) implies (i) follows from Theorem 35. So it remains to be shown that (iii) implies (ii).

Assume there is a list of contractions $M \rightsquigarrow M_1 \rightsquigarrow \dots \rightsquigarrow M_n$ such that M_n is a one-node WF net. For each contraction $M_i \rightsquigarrow M_{i+1}$ it holds that either it contracts a subnet of one node, in which case $M_i \sim M_{i+1}$ and therefore $[M_i] = [M_{i+1}]$, or it contracts a non-trivial subnet, in which case $[M_i] \rightsquigarrow [M_{i+1}]$. It follows that there is a series of class-based contractions $[M] \rightsquigarrow [M'_1] \rightsquigarrow \dots \rightsquigarrow [M'_m]$ such that $M'_m \sim M_n$. It then follows that M'_m is a one-node net and therefore contains no contractible non-trivial subnet, and so $[M'_m]$ is indeed the result of the class-based AND-OR reduction. \square

7 Summary and Future Research

In this paper we introduce a notion of AND-OR reduction, which reduces a WF net to a smaller net by iteratively contracting certain well-formed subnets into single nodes until no more such contractions are possible. This reduction is interesting for several reasons. The first reason is that it preserves the soundness and unsoundness of the net, so can be used to help users understand why a WF net is problematic. It might also give some valuable insights for determining the different possible decompositions, e.g., how parts of the workflow can be best distributed to independent organisational units or, in case of workflows representing computations, e.g., as in scientific workflows, to different servers. The second reason is that it can provide as a side-effect a hierarchical structure of parts, or the whole, of the WF net, which can help user to understand the structure or large WF nets.

Finally, the reduction can be used to show that a certain WF net is an AND-OR net, because in that case the net is reduced to a one-node WF net. This class of WF nets was introduced in earlier work, and arguably describes nets that follow good hierarchical design principles which can be compared to structured design of programs and using well nested procedures and functions,

rather than unrestricted goto statements. As was shown in earlier work, these nets have the desired soundness property.

It is shown that the AND-OR reduction is confluent up to isomorphism, which means that despite the inherent non-determinism that comes from the choice of subnets that are contracted, the final result of the reduction is always the same up to the choice of the identity of the nodes. Based on this result, an algorithm is presented that computes the AND-OR reduction, and runs in polynomial time.

As a byproduct of the reduction procedure, a refinement tree for the hierarchical structure of the net can be constructed, like has been done for similar classes of nets [2, 4, 3]. It is worth to investigate how such refinement trees can be used to determine efficiently sound markings and to model recovery regions. Moreover, it is also interesting to investigate to what extent this hierarchy is unique, or could be made unique by normalising it in a certain way, since that could make it more effective as a tool for understanding the structure of a net. For example, in a refinement tree, if a parent and a child both represent contractions of AND nets, then they can be merged into a single contraction of a larger AND net. Another source of ambiguity comes from the observation that linear nets are simultaneously AND and OR nets. It would be interesting to investigate if these types of ambiguity can describe all the ambiguity, and if a suitable normal form can be defined that always gives a unique and meaningful refinement hierarchy. A possible normalisation procedure could, for example, consist of the following rules: (1) if a parent and a child in the refinement tree represent both the contraction of an AND net or both and OR net, then they should be merged, (2) if a parent represents the contraction of an AND net and it has a child that represents the contraction of an OR net that is equal to the result of the substitution of several OR nets into an AND net (which must be a linear net, since it is also part of an OR net), then the AND net of the child is substituted into the AND net of the parent and the OR nets become the new children that replace the old child, and (3) the same as rule (2) but with the roles of AND and OR interchanged. We conjecture that this leads to a unique normal form for the refinement tree that will be the same if the result of the refinement tree is the same.

Finally, another interesting direction for future research is to extend the class of sound free-choice nets that can be generated as AND-OR nets by having additional substitution rules for edges, and to check if a similar verification procedure by reduction would be possible. We could define ptAND, tpAND, ptOR and tpOR nets where the small letters indicate the type of input and output nodes, respectively. So an edge from a place to a transition could be replaced with a tpAND or tpOR net. Note that the original place and transition remains present. However, this could turn a free-choice net into a non-free-choice net, and indeed create a non-sound net. However, for edges from transitions to places this does not happen as long as we require the ptAND net to be a one-output net, and the tpOR net to be a one-input net. It is also not hard to see that such substitutions preserve soundness. It would be interesting to investigate to what extent this would come close to generating all choice-free

substitution-sound WF nets.

Acknowledgements

This research was sponsored by National Science Centre based on decision DEC-2012/07/D/ST6/02492.

References

- [1] E. Best, R. R. Devillers, and J. Esparza. General refinement and recursion operators for the Petri box calculus. In P. Enjalbert, A. Finkel, and K. W. Wagner, editors, *STACS 93, Proc. of the 10th Annual Symposium on Theoretical Aspects of Computer Science*, volume 665 of *Lecture Notes in Computer Science*, pages 130–140. Springer, February 25-27 1993.
- [2] P. Chrzastowski-Wachtel, B. Benatallah, R. Hamadi, M. O’Dell, and A. Susanto. A top-down Petri net-based approach for dynamic workflow modeling. In *Proceedings of BPM’03*, pages 336–353. Springer-Verlag, 2003.
- [3] P. Chrzastowski-Wachtel, P. Golab, and B. Lewinski. Sound recoveries of structural workflows with synchronization. In M. S. Szczuka, L. Czaja, and M. Kacprzak, editors, *Proceedings of the 22nd International Workshop on Concurrency, Specification and Programming, Warsaw, Poland*, volume 1032 of *CEUR Workshop Proceedings*, pages 73–87. CEUR-WS.org, 2013.
- [4] P. Chrzastowski-Wachtel. Determining sound markings in structured nets. *Fundam. Inf.*, 72(1-3):65–79, Apr. 2006.
- [5] D. De Roure, C. Goble, and R. Stevens. The design and realisation of the virtual research environment for social sharing of workflows. *Future Generation Computer Systems*, 25(5):561 – 567, 2009.
- [6] J. Dehnert and P. Rittgen. Relaxed soundness of business processes. In K. Dittrich, A. Geppert, and M. Norrie, editors, *Advanced Information Systems Engineering*, volume 2068 of *Lecture Notes in Computer Science*, pages 157–170. Springer Berlin Heidelberg, 2001.
- [7] R. Devillers, H. Klaudel, and R. Riemann. General refinement for high level Petri nets. *Foundations of Software Technology and Theoretical Computer Science*, pages 297–311, 1997.
- [8] J. Esparza and M. Silva. Top-down synthesis of live and bounded free choice nets. In G. Rozenberg, editor, *Advances in Petri Nets 1991, Papers from the 11th International Conference on Applications and Theory of Petri Nets*, volume 524 of *Lecture Notes in Computer Science*, pages 118–139. Springer, 1990.

- [9] C. Flender and T. Freytag. Visualizing in the soundness of workflow nets. In *Bericht 267, Tagungsband des 13. Workshops Algorithmen und Werkzeuge für Petri-Netze, AWPN'06, FBI-HH-B-267/06*, pages 47–53, Sep, 06.
- [10] G. Huet. Confluent reductions: Abstract properties and applications to term rewriting systems: Abstract properties and applications to term rewriting systems. *J. ACM*, 27(4):797–821, Oct. 1980.
- [11] G. Keller, M. Nuttigens, and A.-W. Scheer. Semantische prozessmodellierung auf der grundlage: Ereignisgesteuerter prozessketten (EPK). *Veröffentlichungen des Instituts für Wirtschaftsinformatik*, 89, Januar 1992.
- [12] A. Martens. On compatibility of web services. *Petri Net Newsletter*, 65:12–20, 2003.
- [13] A. Martens. Analyzing web service based business processes. In *Proceedings of the 8th International Conference, Held As Part of the Joint European Conference on Theory and Practice of Software Conference on Fundamental Approaches to Software Engineering, FASE'05*, pages 19–33, Berlin, Heidelberg, 2005. Springer-Verlag.
- [14] T. Murata. Petri nets: Properties, analysis and applications. *Proceedings of the IEEE*, 77(4):541–580, Apr 1989.
- [15] Object Management Group (OMG). Business Process Model and Notation (BPMN) Version 2.0. Technical report, <http://www.omg.org/spec/BPMN/2.0/>, January 2011.
- [16] C. A. Petri and W. Reisig. Petri net. *Scholarpedia*, 3(4):64–77, 2008.
- [17] A. Polyvyanyy, L. García-Bañuelos, and M. Dumas. Structuring acyclic process models. *Information Systems*, 37(6):518 – 538, 2012.
- [18] F. Puhmann and M. Weske. Investigations on Soundness Regarding Lazy Activities. In S. Dustdar, J. Fiadeiro, and A. Sheth, editors, *International Conference on Business Process Management (BPM 2006)*, volume 4102 of *Lecture Notes in Computer Science*, pages 145–160. Springer-Verlag, Berlin, 2006.
- [19] J. Sroka, P. Chrzastowski-Wachtel, and J. Hidders. On generating *-sound nets with substitution. *Application of Concurrency to System Design, International Conference on*, 0:3–12, 2011.
- [20] J. Sroka and J. Hidders. On generating *-sound nets with substitution. *Inf. Syst.*, 40:32–46, 2014.
- [21] I. Suzuki and T. Murata. A method for stepwise refinement and abstraction of Petri nets. *Journal of Computer and System Sciences*, 27(1):51–76, 1983.

- [22] N. Trčka, W. M. Aalst, and N. Sidorova. Data-flow anti-patterns: Discovering data-flow errors in workflows. In *Proceedings of the 21st International Conference on Advanced Information Systems Engineering, CAiSE '09*, pages 425–439, Berlin, Heidelberg, 2009. Springer-Verlag.
- [23] W. van der Aalst, G. D. Michelis, and C. Ellis, editors. *Structural Analysis of Workflow Nets with Shared Resources*, volume volume 98/7 of Computer science reports, 1998.
- [24] W. M. P. van der Aalst. The application of Petri nets to workflow management. *Journal of Circuits, Systems, and Computers*, 8(1):21–66, 1998.
- [25] W. M. P. Van Der Aalst, A. H. M. Ter Hofstede, B. Kiepuszewski, and A. P. Barros. Workflow patterns. *Distrib. Parallel Databases*, 14(1):5–51, July 2003.
- [26] W. M. P. van der Aalst, K. M. van Hee, A. H. M. ter Hofstede, N. Sidorova, H. M. W. Verbeek, M. Voorhoeve, and M. T. Wynn. Soundness of workflow nets: classification, decidability, and analysis. *Formal Asp. Comput.*, 23(3):333–363, 2011.
- [27] R. van der Toorn. *Component-based software design with Petri nets: an approach based on inheritance of behavior*. PhD thesis, Eindhoven University of Technology, Eindhoven, The Netherlands, 2004. PhD thesis.
- [28] K. van Hee, N. Sidorova, and M. Voorhoeve. Generalised Soundness of Workflow Nets Is Decidable. In J. Cortadella and W. Reisig, editors, *Application and Theory of Petri Nets 2004*, volume 3099 of *Lecture Notes in Computer Science*, pages 197–215. Springer-Verlag, Berlin, 2004.
- [29] K. M. van Hee, N. Sidorova, and M. Voorhoeve. Soundness and separability of workflow nets in the stepwise refinement approach. In W. M. P. van der Aalst and E. Best, editors, *ICATPN*, volume 2679 of *Lecture Notes in Computer Science*, pages 337–356. Springer, 2003.
- [30] J. Vanhatalo, H. Völzer, and J. Koehler. The refined process structure tree. In M. Dumas, M. Reichert, and M.-C. Shan, editors, *Business Process Management*, volume 5240 of *Lecture Notes in Computer Science*, pages 100–115. Springer Berlin Heidelberg, 2008.
- [31] H. M. W. Verbeek. *Verification of WF-nets*. PhD thesis, Eindhoven University of Technology, Eindhoven, The Netherlands, 2004. PhD thesis.
- [32] H. M. W. Verbeek, T. Basten, and W. M. P. van der Aalst. Diagnosing workflow processes using woflan. *The Computer Journal*, 44(4):246–279, 2001.
- [33] Z. Wang and D. Wei. Modeling complex system using T-subnet based hierarchical Petri nets. *Journal of Computers*, 4(9):829–836, Sep 2009.